



CEDI

TAVOLI & SEDIE

sgabelli, sedie pieghevoli,
tavolini trasformabili, consolle,
ufficio e garden

CATALISTINO 2025.1

INDICE PER CATEGORIA

TAVOLI:

Piani ceramica	da pag. 2
Piani vetro	da pag. 50
Piani vetro trasparente	da pag. 58
Piani legno	da pag. 70
Tondi / Ovali	pag. 70 / da pag. 114
Strutture tavoli x piano cliente	da pag. 110
Classico / Rustico	pag. 133

SEDIE / POLTRONCINE:

Poltrone Living	da pag. 134
Poltroncine tavolo imbottite	da pag. 138
Scocca imbottita	da pag. 142
Moderne Classiche imbottite	da pag. 176
Legno	da pag. 192
Design nordico	da pag. 208
Monoscocche polipropilene	da pag. 212
Polipropilene	da pag. 218
Policarbonato trasparente	da pag. 222
Vintage / Urban	da pag. 246
Rustiche / Country	da pag. 252

SGABELLI:

Alzo gas	da pag. 262
4 gambe / slitta	da pag. 266
Sgabelli H 45	pag. 290

SEDIE PIEGHEVOLI

da pag. 294

TAVOLINI FRONTE DIVANO UP&DOWN

da pag. 298

CONSOLLE

da pag. 308

COMPLEMENTI

da pag. 318

POLTRONCINE UFFICIO / CAMERETTA

da pag. 320



**RICHIEDI PROGRAMMA COMPLETO
OUTDOOR (casa e contract)**

■ **NORMALMENTE IN PRONTA CONSEGNA**
sono i prodotti identificati normalmente a magazzino

INDICE NUMERICO

Tutti i prezzi indicati si intendono Iva esclusa

ART.	PAG.	ART.	PAG.	ART.	PAG.	ART.	PAG.
803	212	8050	238	8129	202	8234	176
807	228	8051	236	8130*	198	8235	178
808	241	8055	240	8133	252	8240*	150
809	220	8056	242	8148*	194	8248	127
8012	232	8057	244	8149	253	8249	125
8013	240	8058	252	8150*	192	8250*	200
8014	230	8062	206	8153	253	8252*	146
8019	214	8063	251	8154	196	8253/4G*	147
8021	234	8064	217	8206*	161	8260	141
8022	208	8069	248	8208	169	8264*	138
8026	210	8075	218	8209	164	8265	138
8027	216	8078	245	8210*	148	8266	172
8028	222	8080	247	8211/4G*	140	8270*	158
8029	224	8084	246	8213	182	8282	163
8033/1-6	226	8085	249	8214	250	8288	209
8033/2	227	8095	207	8215	180	8290	211
8037/1-2	225	8100	166	8216	186	8291	209
8040	235	8116	205	8217*	170	8302	332
8042	38	8119	191	8219	184	8304*	154
8045	233	8122	205	8220	188	8305	152
8048	229	8126	204	8232	190	8306	156

INDICE NUMERICO

ART.	PAG.	ART.	PAG.	ART.	PAG.	ART.	PAG.
8379	142	8579	280	8676/1-2	58	8926/A-B	329
8380*	144	8580	293	8680	133	8927	328
8381*	145	8582/...*	276	8681	32	8928/A-B	330
8382*	174	8583/7	252	8682	32	8931	325
8388	136	8584	263	8685	3	8937	326
8390	136	8585/6-7	291	8686	24	8938	327
8394	137	8590/6-7	292	8687/1-2	70	8944	324
8396	137	8600	60	8688	46	8962	323
8398/...*	134	8601	90	8689	88	8964	320
8427/1-2	334	8608	26	8691	95	8968	322
8434/1-2	335	8610/1-2	118	8692	94	8981	332
8462	294	8611	112	8693	77	8982/...	334
8463	295	8613	47	8695	80	8987	334
8465	297	8615	128	8696	22	8988	327
8468	296	8618	129	8697	78	81065	335
8481/...	295	8619	100	8698	14	81821/12	132
8500/1-2-3	283	8620	116	8699	34		
8506/...*	274	8622	96	8701	84		
8507	290	8623	50	8702	20		
8508/...	290	8624	56	8703	82		
8509/6*	269	8626	98	8704 ME	74		
8510/1-2-3*	278	8629	54	8704 VE	72		
8514/1-2-3	282	8630	40	8706	86		
8517/...*	275	8633	52	8708	76		
8518	279	8635	102	8712	75		
8520/7	234	8635 QD	105	8715	30		
8522	281	8635 VE	57	8718	92		
8526/6-7	287	8636	16	8719	20		
8527	289	8637	45	8725	316		
8528	244	8638	4	8730	312		
8532/6-7	293	8640	124	8732	310		
8538	268	8641/2	130	8733	313		
8540	286	8641/5	131	8738	314		
8542/6-7	285	8643	125	8742	319		
8544/6-7	286	8646/2	133	8744	317		
8549/6-7	284	8647	64	8745	308		
8550	262	8650	8	8749	317		
8557/6*	271	8651	66	8752	310		
8561/6*	270	8654	68	8757	298		
8563	291	8658	114	8758	305		
8564/6-7	288	8661	106	8770	113		
8565	290	8663	108	8830	318		
8566/6*	277	8664	120	8832	318		
8568/...*	272	8665	104	8864	332		
8571/...*	266	8668	57	8879/5	319		
8574*	265	8673	61	8923	332		
8575*	264	8674	62	8926	333		



AREA TECNICA
da pag. 110
solo strutture / piano cliente



* **MODELLI
CUSTOMIZZABILI**
stoffa cliente

CONTRACT



Interno da pag. 254



Esterno da pag. 259



Sedia Art. 809 vedi pag. 220



Art. 8685

le venature dei piani variano da partita a partita

- **NORMALMENTE IN PRONTA CONSEGNA**
- MISURE: 140 x 80 aperto 200 - H 76 1.098,00
- **PIANO GRES OPACO**
- **STATUARIO BIANCO / STRUTTURA METALLO VERNICIATO BIANCO**
- **SAHARA NOIR / STRUTTURA METALLO VERNICIATO ANTRACITE**





GRIGIO LUCIDO Art. 8638 vedi pag. dopo

EMPERADOR LUCIDO



NOIR DESIR OPACO

Sedia Art. 8380 vedi pag. 144





ARABESQUE LUCIDO

Sedia Art. 8305
vedi pag. 152



Art. 8638

- **NORMALMENTE IN PRONTA CONSEGNA**
- **MISURE: 120 x 89 aperto 180 - H 78 chiuso / 76 aperto** 1.770,00
guide alluminio top quality
- **STRUTTURA METALLO VERNICIATO NERO**
- **PIANO VETRO CERAMICA:**
ARABESQUE LUCIDO - GRIGIO LUCIDO - EMPERADOR LUCIDO - NOIR DESIR OPACO

le venature dei piani variano da partita a partita



Sedia Art. 8206
vedi pag. 161

EMPERADOR LUCIDO
da 160

Art. 8650
vedi pag. dopo





NOIR DESIR OPACO da 160

Art. **8650** vedi pag. dopo

Sedia Art. **8210** vedi pag. 148



GRIGIO LUCIDO da 160

Sedia Art. **8209** vedi pag. 164



ARABESQUE LUCIDO da 160

Sedia Art. **8235** vedi pag. 178



Sedia Art. 8304 vedi pag. 154

NOIR DESIR OPACO da 130



MARMO BIANCO LUCIDO da 130

Sedia Art. 8014 vedi pag. 230

Art. 8650

■ NORMALMENTE IN PRONTA CONSEGNA

■ STRUTTURA METALLO VERNICIATO/PIANO VETROCERAMICA

(SPESSORE CERAMICA 6mm + 8mm VETRO)
LE VENATURE VARIANO DA PIANO A PIANO
LE VENATURE DELLE ALLUNGHE POTREBBERO NON COINCIDERE CON I PIANI

2 ALLUNGHE A TIRO

■ MISURE: 130 x 88 aperto 200 - H 76 **1.770,00**

- STRUTTURA NERA / PIANO MARMO NOIR DESIR OPACO
- STRUTTURA NERA / PIANO MARMO GRIGIO LUCIDO
- STRUTTURA NERA / PIANO ARABESQUE LUCIDO **NEWS**
- STRUTTURA BIANCA / PIANO MARMO BIANCO LUCIDO

■ MISURE: 160 x 90 aperto 230 - H 76 **1.893,00**

- STRUTTURA NERA / PIANO MARMO EMPERADOR LUCIDO
- STRUTTURA NERA / PIANO MARMO NOIR DESIR OPACO
- STRUTTURA NERA / PIANO MARMO GRIGIO LUCIDO
- STRUTTURA NERA / PIANO MARMO ARABESQUE LUCIDO



Sedia Art. 8206 vedi pag. 161

Sedia Art. 8206 vedi pag. 161

GRIGIO LUCIDO da 130





SAHARA NOIR OPACO



CALACATTA ORO LUCIDO

Sedia Art. 8208 vedi pag. 169

Art. 8698

- **NORMALMENTE IN PRONTA CONSEGNA**
- MISURE: 180 x 90 aperto 260 - H 76 2.408,00
- BASE METALLO VERNICIATA: **NERA - BRONZO**
- **PIANO SINTERED STONE:**
 SPESSORE PIANO 11MM - 2 ALLUNGHE A TIRO
- CALACATTA ORO LUCIDO**
- SAHARA NOIR OPACO**

Sahara noir opaco



Calacatta Oro lucido

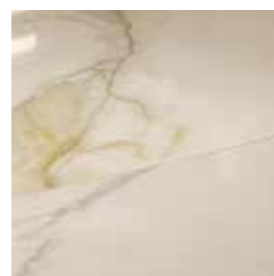

Le venature variano da piano a piano
 Le venature delle allunghe potrebbero non coincidere col piano





Sedia Art. 8282 vedi pag. 163

ARABESQUE LUCIDO

Art. 8636 vedi pag. dopo





Sedia Art. 8264 vedi pag. 138

ARABESQUE LUCIDO



PANDORA LUCIDO



Sedia Art. 8282 vedi pag. 163

GRIGIO LUCIDO

Art. 8636

- **NORMALMENTE IN PRONTA CONSEGNA**
- **MISURE: 200 x 100 aperto 300 - H 76** 2.554,00
- **BASE METALLO VERNICIATA: NERA - BRONZO**
- **PIANO SINTERED STONE:**
 SPESSORE PIANO 11MM - 2 ALLUNGHE A TIRO
ARABESQUE LUCIDO
PANDORA LUCIDO
GRIGIO LUCIDO

Arabesque lucido



Pandora lucido



Grigio lucido



Le venature variano da piano a piano
 Le venature delle allunghe potrebbero non coincidere col piano



- **NORMALMENTE IN PRONTA CONSEGNA**
- **STRUTTURA ACCIAIO VERNICIATO NERO - PIANO H 76**

Sedia 8209 vedi pag. 164

Art. 8702

- **PIANO VETRO CERAMICA OPACO**
(SPESSORE 3 CERAMICA+8 VETRO MM)

LE VENATURE VARIANO DA PIANO A PIANO
LE VENATURE DELLE ALLUNGHE POTREBBERO NON COINCIDERE CON I PIANI

	GRAFITE BROWN	MARMO BIANCO
■ MISURE: 160 x 90 aperto 240	2.867,00	2.934,00
■ MISURE: 180 x 100 aperto 280	3.091,00	3.203,00

solo base Art. 8701
PIANO CLIENTE **SOLO FISSO**

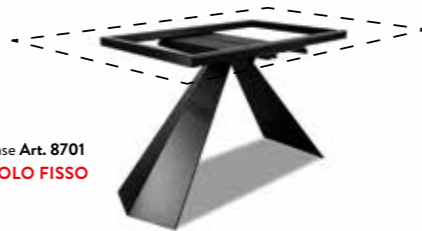

H 73,5
per piano legno/marmo (max 300)

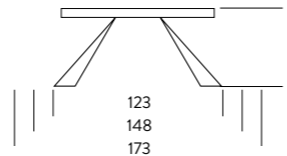

SOLO BASE - PIANO CLIENTE SOLO FISSO
compreso telaio sottostruttura per piano fisso Art. 8701 TL
gambe fissabili a tre posizioni (vedi schema sotto)
1.422,00 supplemento colore BRONZO + 112,00



per piano vetro coprente NB ad appoggio
(no trasparente - max 250)
vite regolabile con ventose, H 2 cm
set 10 pz. 45,00



Art. 8719 Ceramico Plus

- **PIANO VETRO CERAMICA LUCIDO LAMINAM** (SPESSORE 6 CERAMICA+5 VETRO MM)
- **PIANO VETRO CERAMICA OPACO LAMINAM** (SPESSORE 3 CERAMICA+6 VETRO MM)

LE VENATURE DEL PIANO SONO CONTINUE CON LE ALLUNGHE

	CALACATTA ORO OPACO	CALACATTA ORO LUCIDO	THUNDER NIGHT OPACO	THUNDER NIGHT LUCIDO
■ MISURE: 160 x 90 aperto 250	3.550,00	4.020,00	3.662,00	4.020,00
■ MISURE: 180 x 100 aperto 270	3.651,00	4.110,00	3.763,00	4.110,00



MARMO BIANCO



GRAFITE BROWN



THUNDER NIGHT OPACO



CALACATTA ORO OPACO



CALACATTA ORO LUCIDO



THUNDER NIGHT LUCIDO



Art. 8696

- **NORMALMENTE IN PRONTA CONSEGNA**
- MISURE: 300 x 120 - H 76 3.237,00
- **BASE METALLO VERNICIATA NERA**
- **PIANO SINTERED STONE PANDORA LUCIDO**
SPESSORE PIANO 11MM



solo base - piano cliente
Misura top obbligatoria 300x120 cm
1.870,00



Le venature variano da piano a piano



Art. 8686

■ **NORMALMENTE IN PRONTA CONSEGNA**

- MISURE: 200 x 100 - H 75 2.789,00
- MISURE: 238 x 110 - H 75 2.900,00

■ **BASE METALLO VERNICIATA NERA**

■ **PIANO CERAMICA ARABESQUE LUCIDO**
 SPESSORE PIANO 12MM

Le venature variano da piano a piano



solo base - piano cliente
 in fase d'ordine specificare
 telaio sottopiano
 per top da 180/220 o 240/300

1.523,00



NERO VENATO

Poltroncina **8260** vedi pag. 141



VERDE ALPI LUCIDO

Sedia Art. **8235** vedi pag. 178

Art. **8608** vedi pag. dopo





Sedia 8379 vedi pag. 142



Sedia 8240 vedi pag. 150

GREY LUCIDO

BIANCO CARRARA LUCIDO

Sedia 8208 vedi pag. 169



ARABESQUE LUCIDO



Sedia Art. 8208 custom vedi pag. 169

Art. 8608

■ **NORMALMENTE IN PRONTA CONSEGNA**

■ **STRUTTURA ACCIAIO VERNICIATO NERO / PIANO CERAMICA LUCIDA**

	BIANCO CARRARA	GREY	ARABESQUE	MARMO NERO vedi pag. prima	VERDE ALPI vedi pag. prima
■ MISURE: 200 x 100 - H 76	2.789,00	2.789,00	2.789,00	2.789,00	2.789,00
■ MISURE: 238 x 110 - H 76	2.900,00	2.900,00	2.900,00	2.900,00	2.900,00
■ SOLO BASE (PIANO CLIENTE)	1.523,00 NB: in fase d'ordine specificare telaio sottopiano per top da 180/220 o 240/300				





Sedia Art. 8206 vedi pag. 161

Art. 8715

- **NORMALMENTE IN PRONTA CONSEGNA**
- **BASE METALLO VERNICIATA: BIANCA - NERA - BRONZO**
- **CERAMICA LUCIDA FLORIM**
SPESORE 6 MM + 18 MM NOBILITATO H 75

180x100 **RETTANGOLARE:**
 BIANCO CALACATTA ORO **2.565,00**
 NERO THUNDER NIGHT **2.565,00**

200x100 **ELLITTICO:**
 BIANCO CALACATTA ORO **2.677,00**
 NERO THUNDER NIGHT **2.677,00**



solo base - piano cliente **legno**
 ingombro terra 130x70 - H71
 max top 250x120
1.086,00



THUNDER NIGHT



CALACATTA ORO





CALACATTA ORO



THUNDER NIGHT



GREY STONE

Sedia Art. 8304
vedi pag. 154

Sedia Art. 8208 custom vedi pag. 169

■ **NORMALMENTE IN PRONTA CONSEGNA**

- **BASE ACCIAIO VERNICIATA nera**
- **CERAMICA LUCIDA FLORIM**
SPESSORE 6 MM + 18 MM NOBILITATO H 76

- Ø Art. 8681
- Ø 120 BIANCO CALACATTA ORO 2.162,00
- Ø 120 GREY STONE 2.162,00
- Ø 120 NERO THUNDER NIGHT 2.162,00

- Ø 140 BIANCO CALACATTA ORO 2.554,00
- Ø 140 NERO THUNDER NIGHT 2.554,00

solo base Ø 60 - H 74 - piano cliente legno 941,00



- ELLITTICO 200x100 Art. 8682:
- BIANCO CALACATTA ORO 2.935,00
- NERO THUNDER NIGHT 2.935,00

solo base 104x54 - H 74 - piano cliente legno 1.422,00





struttura bianca/**statuario lucido**

Sedia Art. 8209 vedi pag. 164



struttura nera/**thunder night lucido florim**

Art. 8699 vedi 2 pag. dopo



struttura bianca/**calacatta oro florim**

Sedia Art. 8235 vedi pag. 178



struttura nera/**noir desir**

Sedia Art. 8235 vedi pag. 178



Sedia Art. 8206 vedi pag. 161



Art. 8699
vedi pag. dopo



struttura bianca/**calacatta oro**



struttura bianca/**statuario lucido**



Art. 8699 **ceramico plus**

■ PIANO **vetro ceramica** spessore 3+8 mm
 STRUTTURA verniciata - H 76
 ALLUNGA A PORTAFOGLIO laccata gofrata in tinta

■ 120 x 80 aperto 180
 statuario lucido/struttura bianca 1.333,00
 grigio lucido/struttura nera 1.333,00
 noir desir opaco/struttura nera 1.333,00
 calacatta oro lucido/struttura bianca 1.445,00

■ 140 x 90 aperto 200
 statuario lucido/struttura bianca 1.445,00
 calacatta oro lucido/struttura bianca 1.557,00
 calacatta oro lucido/struttura nera 1.557,00
 grigio lucido/struttura nera 1.445,00
 noir desir opaco/struttura nera 1.445,00
 thunder night lucido/struttura nera 1.557,00

■ 160 x 90 aperto 240
 statuario lucido/struttura bianca 1.557,00
 grigio lucido/struttura nera 1.557,00
 noir desir opaco/struttura nera 1.557,00

■ **NORMALMENTE IN PRONTA CONSEGNA**



Sedia Art. 8042 € 143,00
polipropilene: bianca - nera - ottanio - grigia eliminata



struttura nera/thunder night lucido florim

Sedia Art. 8235 vedi pag. 178



struttura nera/grigio lucido

Sedia Art. 8042 vedi pag. 38



Sedia 8234 versione tortora fango vedi pag. 176



- PIANO vetro ceramica spessore 3+8 mm
- STRUTTURA verniciata in tinta - H 76
- ALLUNGA A PORTAFOGLIO laccata goffrata in tinta

Art. 8630

- 120 x 80 aperto 180
- 140 x 90 aperto 200

1.333,00
1.445,00

Art. 8637 Duo

- 140 x 90 aperto 240 (2 allunghe)

1.557,00

COLORI:

- tortora fango
- marmo bianco
- grigio cemento vedi pag. dopo
- antracite vedi pag. dopo
- grafite brown vedi 2 pag. dopo

- **NORMALMENTE IN PRONTA CONSEGNA**

ceramica termoaccoppiata
con vetro molato high quality
per dare resistenza agli urti



Sedia 8019 vedi pag. 214

PIANO IN CERAMICA... ETERNO, INDISTRUTTIBILE...

RESISTENTE A TAGLI, INCISIONI, ALTE TEMPERATURE (PENTOLE BOLLENTI, FERRO DA STIRO, ECC.)



Gamba Evoluzione
a doppio lato incavo





Sedia 8216 versione tortora chiaro vedi pag. 186

cemento



Allunga a libro



Gamba Evoluzione
a doppio lato incavo

- PIANO vetro ceramica spessore 3+8 mm vedi pag. prima
- STRUTTURA verniciata in tinta - H 76
- ALLUNGA A PORTAFOGLIO laccata goffrata in tinta

- Art. 8630
- 120 x 80 aperto 180 1.333,00
- 140 x 90 aperto 200 1.445,00

- Art. 8637 Duo
- 140 x 90 aperto 240 (2 allunghe) 1.557,00

COLORI:

- grigio cemento
- antracite
- tortora fango vedi pag. prima
- marmo bianco vedi pag. prima
- grafite brown vedi pag. dopo
- **NORMALMENTE IN PRONTA CONSEGNA**



Sedia 8234 versione titanio vedi pag. 176

antracite



Sedia 8050 vedi pag. 238





Sedia 8220 vedi pag. 188

- PIANO vetro ceramica spessore 3+8 mm /STRUTTURA verniciata in tinta - H 76
- ALLUNGA A PORTAFOGLIO laccata goffrata in tinta

- Art. 8630
- 120 x 80 aperto 180 1.333,00
 - 140 x 90 aperto 200 1.445,00

- Art. 8637 Duo
- 140 x 90 aperto 240 (2 allunghe) 1.557,00

COLORI:

- grafite brown
- grigio cemento vedi pag. prima
- antracite vedi pag. prima
- tortora fango vedi 2 pag. prima
- marmo bianco vedi 2 pag. prima

- NORMALMENTE IN PRONTA CONSEGNA**



Sedia 8216 vedi pag. 186

Art. 8637

- NORMALMENTE IN PRONTA CONSEGNA**

PIANO vetro ceramica spessore 3+8 mm
STRUTTURA verniciata in tinta
ALLUNGA / E A PORTAFOGLIO laccata goffrata in tinta

- MISURE: 140 x 90 aperto 190/240 (2 allunghe) - H 76

- grigio cemento 1.557,00
- grafite brown vedi pag. lato 1.557,00
- antracite vedi pag. 1 pag. prima 1.557,00
- tortora fango vedi 2 pag. prima 1.557,00
- marmo bianco vedi 2 pag. prima 1.557,00

CERAMICO
DUE ALLUNGHE
140 x 90 + 50 + 50





Sedia Art. 8042 € 143,00
polipropilene: bianca - nera - ottanio - grigia eliminata



Art. 8688

- PIANO **vetro ceramica** spessore 3+8 mm /STRUTTURA **verniciata** - H 77
 ALLUNGA A PORTAFOGLIO **laccata goffrata in tinta**

▪ **90 x 90 aperto 150**

noir desir opaco / struttura nera 1.333,00

- **NORMALMENTE IN PRONTA CONSEGNA**

da 140... a **380** cm

Art. 8613 **Ceramico Black Stone**

- **NORMALMENTE IN PRONTA CONSEGNA**
- **MISURE: 140 x 90 aperto 200/260/320/380 - H 76**
 PIANO **vetro ceramica** spessore 3+8 mm (allunghe in nobilitato)
 STRUTTURA **verniciata antracite**
- **Black Stone SOFT TOUCH** 1.882,00

PIANO IN CERAMICA...
 ETERNO, INDISTRUTTIBILE...

RESISTENTE A TAGLI, INCISIONI,
 ALTE TEMPERATURE
 (PENTOLE BOLLENTI, FERRO DA STIRO, ECC.)





Sedia 8234 vedi pag. 176



Sedia 8234 vedi pag. 176

PIANO IN CERAMICA...
ETERNO, INDISTRUTTIBILE...

RESISTENTE A TAGLI, INCISIONI,
ALTE TEMPERATURE
(PENTOLE BOLLENTI, FERRO DA STIRO, ECC.)

Art. 8613 piano **Ceramico**

■ **NORMALMENTE IN PRONTA CONSEGNA**

■ **140 x 90 aperto 200/260/320/380 - H 76**

■ **PIANO vetro ceramica** spessore 3+8 mm
(allunghe in nobilitato)

■ **STRUTTURA verniciata in tinta**

■ **tortora fango** 1.882,00

■ **marmo bianco** 1.882,00

da 140... a **380** cm



Sedia 8050 vedi pag. 238



ceramica termoaccoppiata
con vetro molato high quality
per dare resistenza agli urti



mini rotelle per apertura





Art. 8623 piano **Vetro**

■ **NORMALMENTE IN PRONTA CONSEGNA**

■ **MISURE:** 140 x 90 aperto 200/260/320/380 - H 76
allunghe nobilitato in tinta

■ **PIANO VETRO TEMPERATO 10 MM tortora chiaro lucido**
STRUTTURA IN TINTA **1.411,00**

■ **PIANO VETRO TEMPERATO 10 MM extrawhite lucido**
STRUTTURA **bianca** **1.445,00**

da 140... a **380** cm

le 4 allunghe sono alloggiate all'interno



due gambe sostegno integrate

Sedia 8216 versione tortora chiaro
vedi pag. 186



mini rotelle per apertura

Sedia 8234
vedi pag. 176





Sedia Art. 8206 vedi pag. 161

BIANCO/VETRO EXTRAWHITE LUCIDO



Art. 8633

■ **NORMALMENTE IN PRONTA CONSEGNA**

■ **MISURE: 160 x 90 aperto 240 - H 76**
mono allunga a libro laccata in tinta

■ **PIANO VETRO TEMPERATO 10 MM extrawhite lucido/STRUTTURA METALLO VERNICIATA BIANCA 1.310,00**

■ **PIANO VETRO TEMPERATO 10 MM titanio lucido/STRUTTURA METALLO VERNICIATA TITANIO 1.221,00**



Sedia Art. 8210 vedi pag. 148

TITANIO/VETRO TITANIO LUCIDO



bianco/vetro extrawhite lucido

allunghe a libro - laccate lucide in tinta



Art. 8629

■ **NORMALMENTE IN PRONTA CONSEGNA**

■ **MISURE H 76:**

120 x 80 aperto 180

- VETRO TEMPERATO 10 MM tortora chiaro lucido
STRUTTURA tortora chiaro 997,00
- VETRO TEMPERATO 10 MM extrawhite lucido
STRUTTURA bianca 997,00
- VETRO TEMPERATO 10 MM titanio lucido
STRUTTURA titanio 963,00

140 x 90 aperto 200

- VETRO TEMPERATO 10 MM tortora chiaro lucido
STRUTTURA tortora chiaro 1.086,00
- VETRO TEMPERATO 10 MM extrawhite lucido
STRUTTURA bianca 1.086,00
- VETRO TEMPERATO 10 MM titanio lucido
STRUTTURA titanio 1.030,00



titanio/vetro in tinta

tortora chiaro/vetro in tinta





Sedia Art. 8219 vedi pag. 184

Sedia Art. 8042 vedi pag. 47



Sedia eliminata

Struttura bianca



Art. 8624

■ **NORMALMENTE IN PRONTA CONSEGNA**

■ VETRO TEMPERATO 10 MM:
antracite scuro lucido / STRUTTURA nera
bianco lucido extrawhite / STRUTTURA bianca

■ MISURE H 76:
120 x 75 aperto 170 **1.075,00**

ALLUNGA A LIBRO NOBILITATO IN TINTA



Art. 8668

■ **NORMALMENTE IN PRONTA CONSEGNA**

■ MISURE: 90 x 90 aperto 180 - H 76

■ STRUTTURA bianca / VETRO 6 MM SERIGRAFATO **739,00**

■ STRUTTURA tortora chiaro / VETRO 6 MM IN TINTA **739,00**

Struttura tortora chiaro



Sedia eliminata



Art. 8635 VE vetro

■ **NORMALMENTE IN PRONTA CONSEGNA**

■ FISSO metallo verniciato ALLUMINIO / VETRO EXTRAWHITE

■ 110 x 70 **778,00**

■ 130 x 80 **840,00**

■ ALLUNGABILE metallo verniciato:

ALLUMINIO - BIANCO - ANTRACITE / VETRO EXTRAWHITE

■ 110 x 70 aperto 165 **997,00**

■ 130 x 80 aperto 190 **1.109,00**



Sedia Art. 8216 vedi pag. 186

Art. 8676/2

- **NORMALMENTE IN PRONTA CONSEGNA**
- VETRO TEMPERATO TRASPARENTE (PIANO SPESSORE 10 MM - GAMBE 18 MM - SPAZIO TRA LE DUE GAMBE 87 CM)
- STRUTTURA METALLO CROMATO
- MISURE: 140 x 80 aperto 200 - H 75 1.557,00

Guide Acciaio Inox
data la particolarità di questo materiale
lavorato al vivo, può essere soggetto
a leggere imperfezioni che sono
caratteristiche della lavorazione di tale
materia e non interferiscono con il fascino
e l'aspetto estetico del tavolo

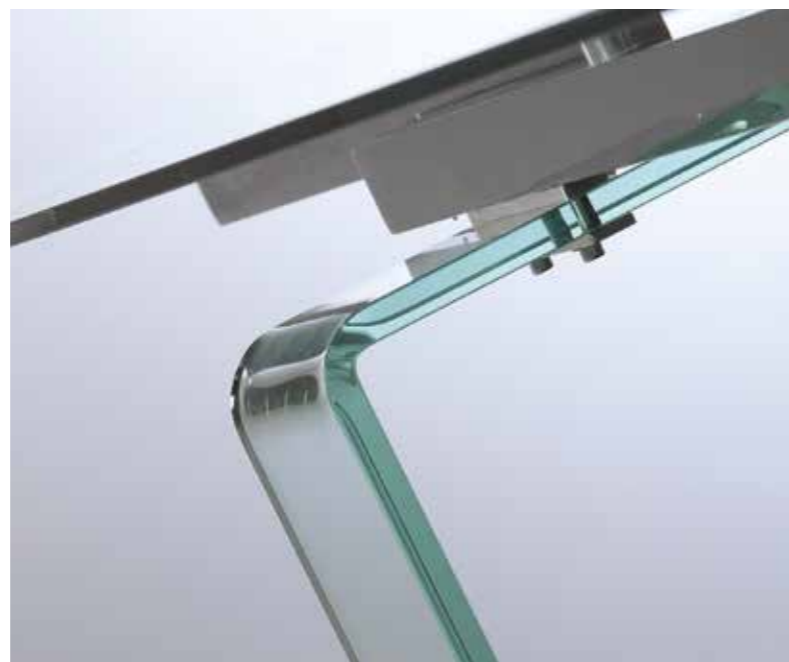

Art. 8676/1

- **NORMALMENTE IN PRONTA CONSEGNA**
- VETRO TEMPERATO TRASPARENTE (PIANO SPESSORE 12 MM - GAMBE 19 MM - SPAZIO TRA LE DUE GAMBE 104 CM)
- STRUTTURA ACCIAIO INOX LUCIDO
- MISURE: 160 x 90 aperto 240 - H 77 1.669,00



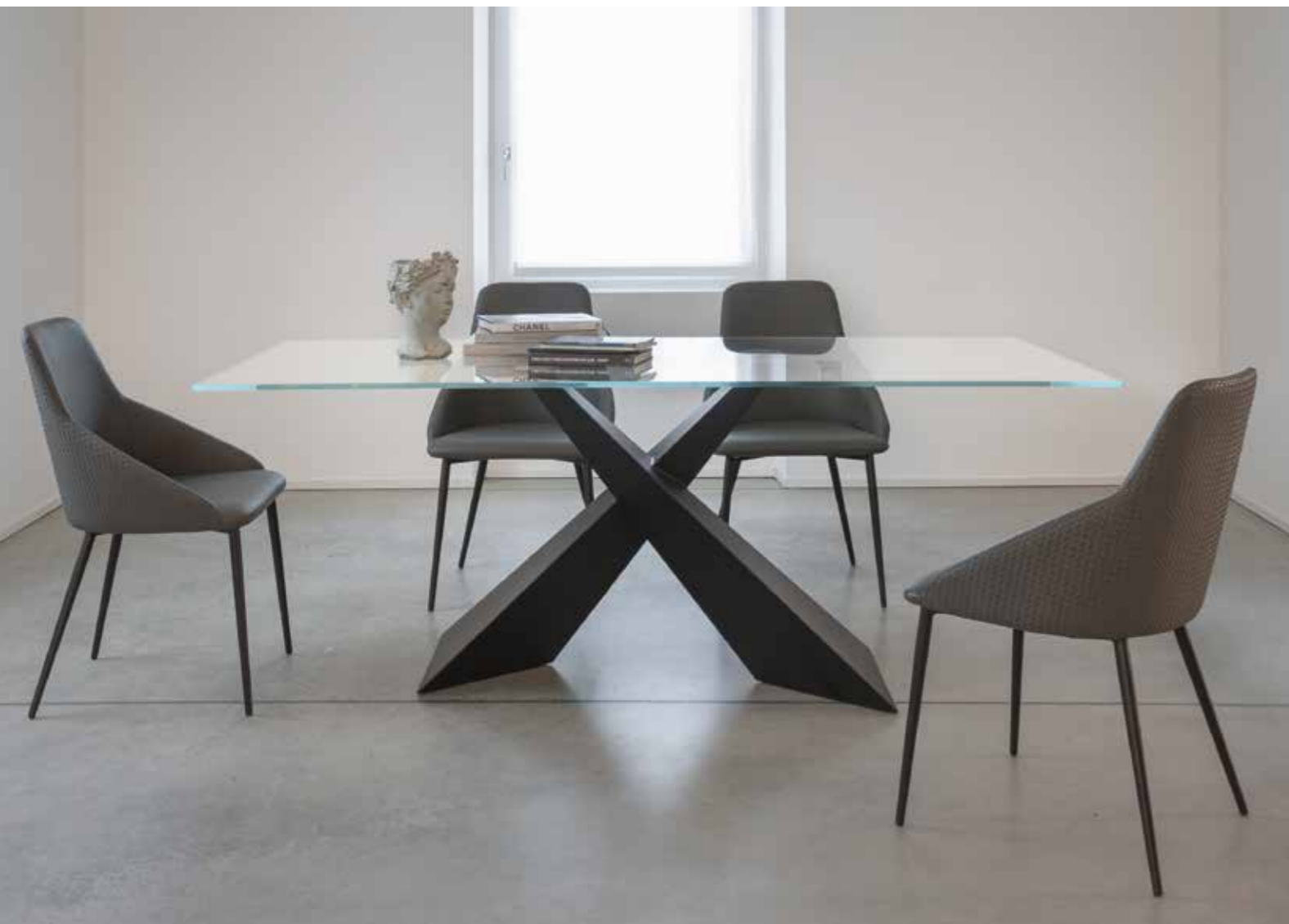

Sedia Art. 8100 vedi pag. 166

Art. 8600

■ **NORMALMENTE IN PRONTA CONSEGNA**

■ **VETRO TEMPERATO TRASPARENTE EXTRACHIARO, SPESSORE 12 MM - H 76**
INCOLLATO SU PIASTRE ACCIAIO SATINATO SPAZZOLATO

■ **STRUTTURA METALLO VERNICIATA NERA**
■ MISURE: 180 x 100 2.565,00
■ MISURE: 200 x 100 2.666,00

■ **STRUTTURA METALLO VERNICIATA BRONZO**
■ MISURE: 180 x 100 2.677,00
■ MISURE: 200 x 100 2.778,00



Sedia Art. 8380 gamba bronzo vedi pag. 144



Sedia Art. 8253/4G vedi pag. 147

Art. 8673

■ **NORMALMENTE IN PRONTA CONSEGNA**

■ **STRUTTURA: CROMATA - NERA**

PIANI VETRO TEMPERATO TRASPARENTE 12 MM
in appoggio su ventosine

■ MISURE: 140 x 80 - H 77 918,00
■ MISURE: 160 x 85 - H 77 974,00
■ MISURE: 180 x 90 - H 77 1.042,00

■ **SOLO BASE** piano cliente vetro
da 140 650,00
da 160 683,00
da 180 717,00





Sedia Art. 8122 versione sabbia vedi pag. 205



Sedia Art. 8213 vedi pag. 182 gamba cromo eliminata

Sedia Art. 8213 vedi pag. 182



Art. 8674

- **NORMALMENTE IN PRONTA CONSEGNA**
- **PIANI VETRO TEMPERATO TRASPARENTE 10 MM**
STRUTTURA VERNICIATA:
 bianca
 tortora chiaro
 nera
- **MISURE: 160 x 90 aperto 240 - H 76** **1.434,00**

Art. 8647

■ **NORMALMENTE IN PRONTA CONSEGNA**

■ **STRUTTURA ACCIAIO INOX LUCIDO / PIANO VETRO TEMPERATO 10 MM**
GAMBE MASSELLO TINTO:
noce americano

■ **MISURE: 160 x 90 aperto 240 - H 77** **2.005,00**

■ **MISURE: 180 x 100 aperto 260 - H 77** **2.195,00**

Acciaio Inox
data la particolarità di questo materiale
lavorato al vivo, può essere soggetto
a leggere imperfezioni che sono
caratteristiche della lavorazione di tale
materia e non interferiscono con il fascino
e l'aspetto estetico del tavolo

Sedia Art. 8240 vedi pag. 150





Sedia Art. 8240 vedi pag. 150

Art. 8651

■ **NORMALMENTE IN PRONTA CONSEGNA**

- STRUTTURA ACCIAIO INOX LUCIDO / VETRO TEMPERATO 10 MM
- GAMBE MASSELLO TINTO **noce americano**

■ MISURE: 160 x 90 aperto 240 - H76

2.005,00

L'acciaio Inox
 data la particolarità di questo materiale
 lavorato al vivo, può essere soggetto
 a leggere imperfezioni che sono
 caratteristiche della lavorazione di tale
 materia e non interferiscono con il fascino
 e l'aspetto estetico del tavolo

Nuova struttura scatolata
 I longaroni porta
 allunghe rimangono
 integrati all'interno





Sedia eliminata

Art. 8654

- **NORMALMENTE IN PRONTA CONSEGNA**
- STRUTTURA ACCIAIO INOX LUCIDO
VETRO TEMPERATO 10 MM
- MISURE: 160 x 90 aperto 240 - H 76
- GAMBE MASSELLO TINTO:

noce americano	1.882,00
naturale	1.882,00

Acciaio Inox
data la particolarità di questo materiale lavorato al vivo, può essere soggetto a leggere imperfezioni che sono caratteristiche della lavorazione di tale materia e non interferiscono con il fascino e l'aspetto estetico del tavolo



Art. 8687/2 ellittico

- BASE TAMBURATA
- PIANO IMPIALLACCIATO BORDO MASSELLO: **noce contemporaneo - laccato nero poro aperto**
- MISURE: 200 x 110 - H 76 **1.882,00**

■ **NORMALMENTE IN PRONTA CONSEGNA**

Art. 8687/1 tondo

- BASE TAMBURATA
- PIANO IMPIALLACCIATO BORDO MASSELLO: **laccato nero poro aperto**
- MISURE: Ø 120 - H 76 **1.445,00**

Poltroncina **8276** - laccata nera/simil paglia € 334,00 - imballo 2pz.



Poltroncina Art. 8150 vedi pag. 192





Il fascino della natura, ogni piano è unico...



Sedia eliminata

Art. 8704 VE

■ **NORMALMENTE IN PRONTA CONSEGNA**

■ **BASE VETRO 15 MM**
la base è composta da 2 blocchi fissati al piano

■ **PIANO H 76 FRASSINO MASSELLO* SPAZZOLATO TINTO NATURALE CHIARO/BORDO EFFETTO CORTEC**

■ MISURE: 200 x 100 (spessore 4) **2.386,00**

■ MISURE: 250 x 100 (spessore 4) **2.710,00**

■ **PIANO H 76 ROVERE MASSELLO* TINTO A OLIO NATURALE CALDO/BORDO EFFETTO CORTECCIA**

■ MISURE: 200 x 100 (spessore 4) **2.498,00**

■ MISURE: 250 x 100 (spessore 4) **2.845,00**

■ **SOLO BASE piano cliente 997,00**



PIANO ROVERE MASSELLO
TINTO A OLIO



*Il fascino della natura,
ogni piano è unico...*

*I piani in massello essendo in materiale naturale tendono a muoversi ai cambi di stagione e di temperatura, contribuendo alla particolarità ed al pregio di questo prodotto

Poltroncina Art. 8290 vedi pag. 211



*Il fascino della natura,
ogni piano è unico...*

Art. 8704 ME

- **NORMALMENTE IN PRONTA CONSEGNA**
- **BASE METALLO VERNICIATO NERO OPACO**
- **PIANO H 75 FRASSINO MASSELLO*
SPAZZOLATO TINTO NATURALE CHIARO
BORDO EFFETTO CORTECCIA**
- MISURE: 200 x 100 (spessore 4) **2.050,00**
- MISURE: 250 x 100 (spessore 4) **2.374,00**
- **PIANO H 75 ROVERE MASSELLO*
TINTO A OLIO NATURALE CALDO
BORDO EFFETTO CORTECCIA**
- MISURE: 200 x 100 (spessore 4) **2.162,00**
- MISURE: 250 x 100 (spessore 4) **2.509,00**
- **SOLO BASE piano cliente** **661,00**
la base è a due blocchi,
senza piano non è autoportante



PIANO ROVERE MASSELLO
TINTO A OLIO



Sedia Art. 8253/4G vedi pag. 147



Art. 8712

- **NORMALMENTE IN PRONTA CONSEGNA**

- **BASE METALLO VERNICIATO NERO OPACO**
- **PIANO H 77 IMPIALLACCIATO ROVERE TINTO OLIO*
NATURALE CHIARO
BORDO EFFETTO CORTECCIA IMPIALLACCIATO**
- MISURE: 160 x 90 **1.322,00**
spazio tra gamba e gamba 117
- MISURE: 180 x 90 (spessore 4) **1.355,00**
spazio tra gamba e gamba 120
- **PIANO H 77 ROVERE MASSELLO TINTO OLIO*
NATURALE CALDO
BORDO EFFETTO CORTECCIA IMPIALLACCIATO**
- MISURE: 160 x 90 **1.557,00**
spazio tra gamba e gamba 117
- MISURE: 180 x 90 (spessore 4) **1.602,00**
spazio tra gamba e gamba 120

- **SOLO BASE piano cliente**
la base è a due blocchi,
senza piano non è autoportante
650,00





Sedia Art. 8130 vedi pag. 198



da 180... a **360** cm

Tavolo Art. 8708

- **NORMALMENTE IN PRONTA CONSEGNA**
- STRUTTURA MASSELLO DI FRASSINO TINTO NATURALE
- PIANO IMPIALLACCIATO FRASSINO LACCATO BIANCO PORO APERTO
- MISURE: 180 x 90 aperto 240/300/360 - H 75

2.218,00



Madia Art. 8693

- **NORMALMENTE IN PRONTA CONSEGNA**
- ANTE MASSELLO
- STRUTTURA LISTELLARE IMPIALLACCIATA FRASSINO OLIVATO TINTO NATURALE
- PIEDI METALLO VERNICIATI NERO
- MISURE: 185 x 45 - H 75

2.643,00





Sedia eliminata



Sedia Art. 8206 vedi pag. 161

da 160... a **410** cm
da 200... a **500** cm

Art. 8697

■ **NORMALMENTE IN PRONTA CONSEGNA**

■ **GAMBE METALLO VERNICIATE NERE**

■ **PIANO nobilitato:** cemento rovere nodato
FOLDING H FASCIA 9 CM

■ **MISURE H 76:**

160 x 90 aperto 410 **1.848,00 1.848,00**
(14 posti larghi - 5 allunghe)
spazio tra gamba e gamba 93

200 x 100 aperto 500 **1.893,00 1.893,00**
(18 posti - 6 allunghe)
spazio tra gamba e gamba 100





Sedia Art. 8122 vedi pag. 205



Sedia Art. 8220 vedi pag. 188

Art. 8695

■ **NORMALMENTE IN PRONTA CONSEGNA**

■ **PIANO nobilitato:** **bianco poro aperto** **rovere nodato**
 GAMBE MDF RIVESTITO

■ **MISURE H 75:**

160 x 90 aperto 360 **1.546,00** **1.546,00**
 (14 posti)

200 x 100 aperto 500 **1.669,00** **1.669,00**
 (18 posti)

da 160... a **360** cm
 da 200... a **500** cm



H fascia 9 cm





Gambe montate a filo

Sedia eliminata



Gambe montate a sbalzo

Sedia Art. 8216 versione tortora fango vedi pag. 186



Art. 8703

■ **NORMALMENTE IN PRONTA CONSEGNA**

■ **PIANO nobilitato:** bianco poro aperto rovere nodato
GAMBE MDF RIVESTITO

■ **MISURE H 75:**

160 x 90 aperto 260 **1.198,00** **1.198,00**

180 x 90 aperto 280 **1.221,00** **1.221,00**

NOTA BENE: L'INCROCIO DELLE GAMBE PUÒ ESSERE MONTATO A FILO (VEDI FOTO VERSIONE BIANCA) OPPURE A SBALZO (VEDI VERSIONE ROVERE)



Sedia Art. 8220 vedi pag. 188



ROVERE BARRIQUE

ROVERE NODATO



Sedia Art. 8210 vedi pag. 148



TRANCHÈ T. ANTRACITE

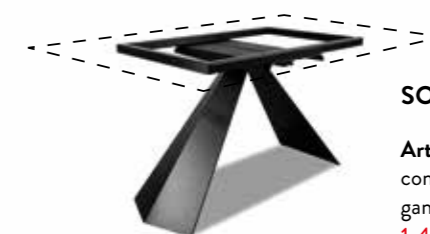

SOLO BASE - PIANO CLIENTE SOLO FISSO

Art. 8701 TL
compreso telaio sottostruttura per piano fisso
gambe fissabili a tre posizioni (vedi schema sotto)
1.422,00 supplemento colore BRONZO + 112,00

H 73,5
per piano legno/marmo (max 300)

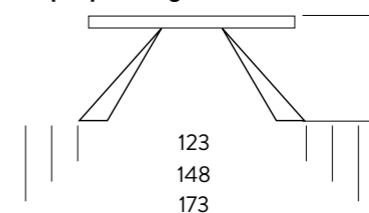

per piano vetro coprente NB ad appoggio
(no trasparente - max 250)
vite regolabile con ventose, H 2 cm
set 10 pz. **45,00**



Art. 8701

■ **NORMALMENTE IN PRONTA CONSEGNA**

■ **STRUTTURA METALLO VERNICIATO NERA**

■ NOBILITATO FOLDING: **TRANCHÈ T. ANTRACITE**

■ 160 x 90 aperto 260 **1.982,00**
■ 180 x 90 aperto 280 **2.005,00**

H FASCIA 8 CM - due allunghe a portafoglio

ROVERE BARRIQUE

1.982,00

-

ROVERE NODATO

1.982,00

2.005,00



Sedia Art. 8305 vedi pag. 152

rovere barrique



Sedia Art. 8215 vedi pag. 180

tranchè tinto antracite



rovere nodato



solo base
(piano cliente fisso,
misura base 136x84)
851,00

H FASCIA 8 CM - due allunghe a portafoglio

Art. 8706

- **NORMALMENTE IN PRONTA CONSEGNA**
- **STRUTTURA METALLO VERNICIATO: NERA**

▪ NOBILITATO FOLDING:	TRANCHÈ T. ANTRACITE	ROVERE BARRIQUE	ROVERE NODATO
▪ 160 x 90 aperto 260	1.860,00	1.860,00	1.860,00
▪ 180 x 90 aperto 280	1.893,00	-	1.893,00



Sedia Art. 8252 vedi pag. 146

rovere naturale



Sedia Art. 8240 vedi pag. 150

cemento classico

Art. 8689

■ **NORMALMENTE IN PRONTA CONSEGNA**

■ **MISURE: 160 x 90 aperto 270 - H 75** **2.117,00**
(2 allunghe da 55)

■ **BASE METALLO VERNICIATA: bianca - nera**

■ **PIANO LAMINATO 25 MM:**
cemento classico - pietra grey - rovere naturale

solo struttura (piano cliente) **1.445,00**
allunghe a pannello, alloggiato internamente



Sistema di allunga
con piano e carrello traslante,
permette di avere la base sempre in posizione centrale

pietra grey





Sedia Art. 8304 vedi pag. 154



Sedia Art. 8014 vedi pag. 230

Art. 8601

- **NORMALMENTE IN PRONTA CONSEGNA**
- **MISURE: 140 x 90 aperto 180/220 - H 76**
- **STRUTTURA METALLO VERNICIATO NERA**
- **NOBILITATO:**
 rovere nodato - cemento
 antracite - pietra grey

1.333,00

SOLO BASE H74 - PIANO CLIENTE 997,00



Piedino regolabile

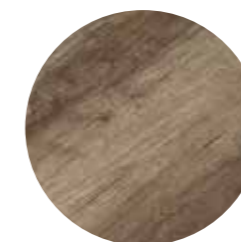

rovere nodato



cemento



antracite



pietra grey



Sedia Art. 8045 vedi pag. 233

Art. 8718

- **NORMALMENTE IN PRONTA CONSEGNA**
- **MISURE: 130 x 80 aperto 190 - H 75** **1.199,00**
- **BASE METALLO VERNICIATA: bianca - nera**
- **PIANO NOBILITATO: cemento classico - cemento ossido - pietra grey - rovere nodato**

solo struttura (piano cliente) **885,00**
 allunga a pannello, alloggiata internamente

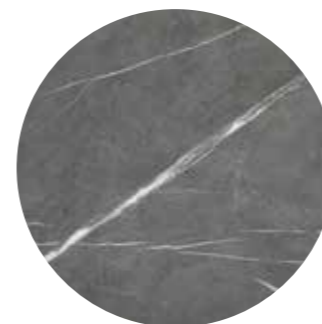

pietra grey



rovere nodato



cemento ossido



cemento classico

IL PRIMO TAVOLO,
 BASE AD INCROCIO

CON MISURE
 DA CUCINA 130x80



cemento classico





Sedia eliminata

fermo blocca chiusura



Versione **rovere nodato**



Versione **rovere gessato**

Art. 8692

■ **NORMALMENTE IN PRONTA CONSEGNA**

■ PIANO NOBILITATO / GAMBE MDF (12x5) - H 75

■ MISURE: 140 x 90 aperto 200
rovere nodato - rovere gessato

885,00

■ MISURE: 160 x 90 aperto 205/250
rovere nodato - rovere gessato

941,00



Sedia Art. 8130 vedi pag. 198

piano e allunghe
listellare impiallacciato

meccanismo/struttura telescopica high quality
(quando aperto evita le gambe di supporto centrali)



gambe massello

Art. 8691

■ **NORMALMENTE IN PRONTA CONSEGNA**

■ GAMBE MASSELLO (SEZIONE 9 x 11)
PIANO LISTELLARE IMPIALLACCIATO - H 77
FRASSINO OLIVATO TINTO naturale

■ MISURE:
140 x 90 aperto 290 (3 allunghe) 2.229,00



la vena dell'impiallacciatura delle allunghe
può essere di un'altra partita rispetto ai piani



bronzo tadao

Sedia Art. 8305 vedi pag. 152

Art. 8622 - HPL rettangolare allungabile

Tavolo completo TEMPI 30 GG

Solo strutture NORMALMENTE IN PRONTA CONSEGNA

■ STRUTTURA ALLUMINIO:

- verniciata nera
- verniciata bronzo

HPL 12 MM CORPO SCURO
grafite
lavagna
ardesia
pietra kaspio
rovere nodato
bronzo tadao

HPL 10 MM CORPO NERO
carrara gold

solo struttura

per piano cliente
predisposto per 1/2 allunghe

Dimensione	HPL 12 MM CORPO SCURO	HPL 10 MM CORPO NERO	solo struttura
120 x 80 aperto 160 - H 76 (1 allunga)	1.277,00	1.277,00	-
120 x 80 aperto 160/200 - H 76 (2 allunghe)	1.434,00	1.434,00	728,00
140 x 90 aperto 180 - H 76 (1 allunga)	1.445,00	1.445,00	-
140 x 90 aperto 180/220 - H 76 (2 allunghe)	1.613,00	1.613,00	773,00



CARRARA GOLD
10 MM



LAVAGNA
12 MM

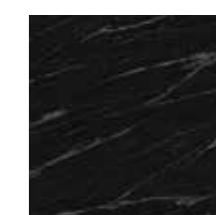

ARDESIA
12 MM

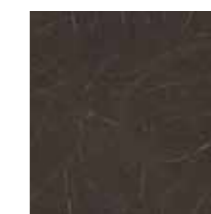

GRAFITE
12 MM

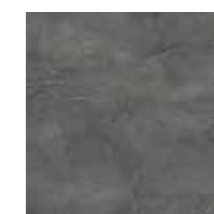

PIETRA KASPIO
12 MM



ROVERE NODATO
12 MM



struttura alluminio anodizzato



versione struttura antracite / piano Rovere

Sedia Art. 8050 vedi pag. 238



versione struttura bianca / piano Bianco

Art. 8626

■ **NORMALMENTE IN PRONTA CONSEGNA**

■ **STRUTTURA ALLUMINIO:**

- naturale anodizzato
- verniciata bianca
- verniciata antracite

■ 130 x 80 aperto 168/205 - H 77

■ 160 x 90 aperto 206/253/300 - H 77

tasselli colori piani vedi pag. dopo

NOBILITATO
bianco

1.176,00

1.669,00

NOBILITATO SPECIAL:
cemento
antracite
pietra grey
rovere nodato

1.221,00

1.747,00

solo struttura

per piano / allunghie cliente
allunghie a pannello
alloggiate internamente
max 20 mm

997,00

1.333,00





Sedia Art. 8215 vedi pag. 180

Art. 8619

■ **NORMALMENTE IN PRONTA CONSEGNA**

H 77

■ **STRUTTURA METALLO VERNICIATA:**
- nera

(guide alluminio anodizzato TOP QUALITY)



NOBILITATO SPECIAL:

cemento **pietra grey** **antracite** **rovere nodato**
per piano / allunghe cliente

■ 120 x 80 aperto 165/210	1.131,00	1.131,00	1.131,00	1.131,00
■ 120 x 80 aperto 160/ 200/240/280	-	1.624,00	1.624,00	1.624,00
■ 140 x 90 aperto 185/230	1.310,00	1.310,00	1.310,00	1.310,00
■ 140 x 90 aperto 185/ 230/275	1.512,00	1.512,00	1.512,00	1.512,00
■ 160 x 90 aperto 205/250/295	1.546,00	1.546,00	1.546,00	1.546,00

solo struttura

max spessore 20 mm
allunghe a pannello
alloggiate internamente



Agganciabile basi cucina

solo piano cliente
detrarre 8 cm da misure di serie
NB: DAL LATO LUNGO
*detrarre € 78,00 dal listino
Art. 8619/FIX

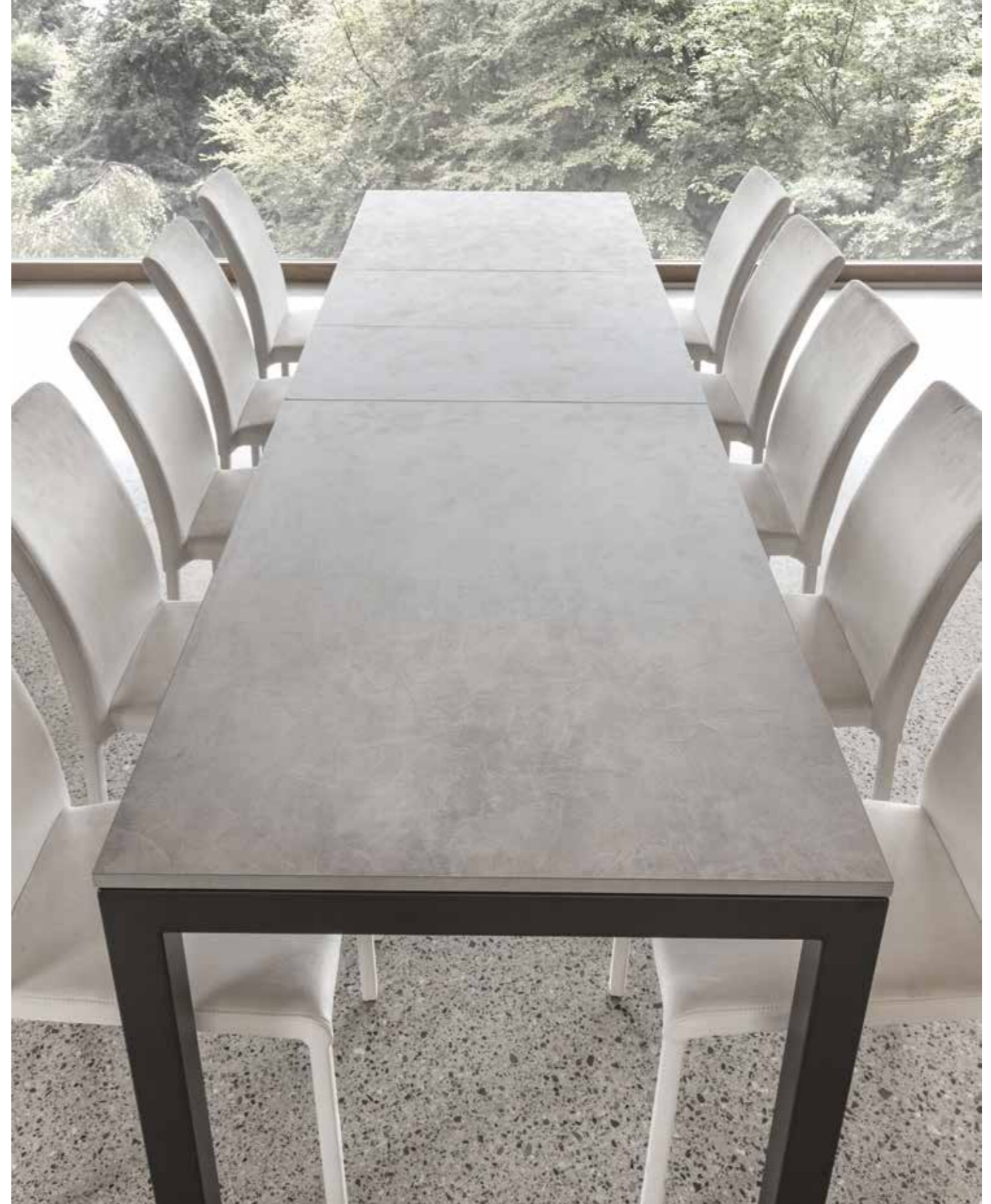

Sedia Art. 8219 vedi pag. 184



cemento

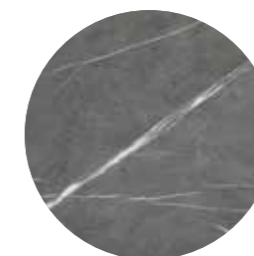

pietra grey



antracite



rovere nodato



Sedia Art. 8012 vedi pag. 232



Sedia eliminata



Art. 8635

■ **NORMALMENTE IN PRONTA CONSEGNA**

■ **STRUTTURA:**
- alluminio
- bianca
- antracite

- 110 x 70 aperto 165 - H 76
- 130 x 80 aperto 190 - H 76
- 110 x 70 fisso - H 76 (solo alluminio)
- 130 x 80 fisso - H 76 (solo alluminio)

**NOBILITATO
bianco**

666,00
706,00
482,00
515,00

NOBILITATO SPECIAL:
cemento
antracite
pietra grey
rovere nodato

739,00
778,00

solo struttura
(H sotto telaio 68)
per piano cliente max 20 mm
allunga a libro nobilitato **alluminio**
55 x 70 **123,00**
60 x 80 **134,00**
Kit ferramenta allungha **31,00**

442,00
493,00
325,00
336,00





Art. 8665

Sedia eliminata

■ **NORMALMENTE IN PRONTA CONSEGNA**

■ **STRUTTURA METALLO VERNICIATA: alluminio-bianco-antracite**
PIANO NOBILITATO **bianco**

■ **MISURE: 90 x 60 aperto 140 - H 76**

solo struttura (piano cliente)

allunga a pannello, alloggiata internamente

554,00

426,00



Sedia Art. 8050 vedi pag. 238



Sedia Art. 8465
vedi pag. 297



allunga a pacchetto

allunga telescopica

Art. 8635 QD

■ **NORMALMENTE IN PRONTA CONSEGNA**

■ **STRUTTURA METALLO VERNICIATA: alluminio**
PIANO H 76 NOBILITATO **bianco**

■ **MISURE: 90 x 90 aperto 150**

solo struttura piano cliente

762,00

504,00



Sedia Art. 807 vedi pag. 228



Sedia Art. 809 vedi pag. 220

versione struttura **bianca** / piano marmo bianco liscio



Sedia Art. 8304 vedi pag. 154

versione struttura **nera** / piano ceramica nero venato

Art. 8661

Strutture / piani ceramici **NORMALMENTE IN PRONTA CONSEGNA**
Piani HPL TEMPI 30 GG

STRUTTURA ALLUMINIO: - verniciata nera - verniciata bianca	CERAMICA OPACA	HPL 12 MM CORPO NERO	HPL 10 MM CORPO NERO	solo struttura per piano cliente taglio struttura su misura + € 100,00 netti  TAGLIO A MISURA
	bianco statuario nero venato	grafite lavagna pietra kaspio rovere nodato	cemento marmo bianco liscio bianco unito rovere naturale	
■ 130 x 80 - H 75	974,00	1.053,00	1.053,00	582,00
■ 160 x 90 - H 75	1.075,00	1.299,00	1.299,00	661,00
■ 200 x 100 - H 75	1.221,00	1.646,00	1.646,00	762,00

Dalle misure indicate manca 1 cm

COLORI HPL 10 MM



ROVERE NATURALE
4543 FIN. ALEVE
corpo marrone



CEMENTO FIN.
PIETRA
3192 FIN. LUNA
corpo nero



MARMO BIANCO
LISCIO
5547 FIN. OPACA
corpo nero



BIANCO UNITO
001 FIN. R.
corpo nero



COLORI HPL 12 MM

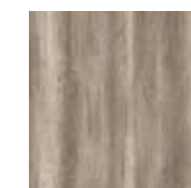

ROVERE NODATO
(country oak)

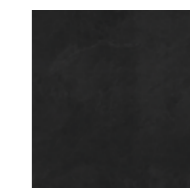

LAVAGNA

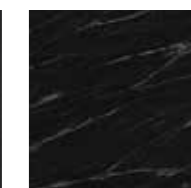

ARDESIA



PIETRA KASPIO

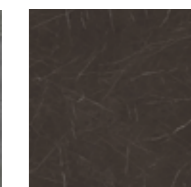

GRAFITE



Sedia Art. 8057 vedi pag. 244



Agganciabile basi cucina

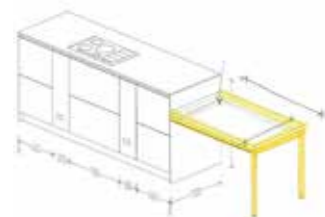

solo piano cliente
detrarre 3 cm da misure di serie NB: DAL LATO LUNGO
accessorio per ancoraggio Art. 8663/FIX € 20,00

particolare giunto brevettato

NUOVA VERSIONE H110

H110 verniciato: **bianco e antracite**
+ € 123,00 da prezzo versione H73

NORMALMENTE IN PRONTA CONSEGNA

taglio struttura misura + 70,00 netti
ANCHE IN ALTEZZA + 40,00 netti



BIANCO UNITO



ROVERE NATURALE (V32)



CEMENTO (44375)



ANTRACITE (KINDL)



Sedia eliminata

Art. 8663 IL TAVOLO FISSO... AL CENTIMETRO

■ **NORMALMENTE IN PRONTA CONSEGNA**, solo struttura misure di serie - *taglio struttura misura + 70,00 netti (LE STRUTTURE SONO PIÙ CORTE DI 1 CM PER LATO, TEMPI 30 GG)
adatto per piani in marmo, agglomerati, ecc. (non adatto per piani vetro trasparente)

MISURE: SEZIONE GAMBA 4 X 4	80 x 80 90 x 90	120 x 70	120 x 80	140 x 80	160 x 90	180 x 90
■ COMPLETO DI PIANO NOBILITATO 20 mm bianco - H 75	549,00	594,00	605,00	638,00	689,00	728,00
■ rovere naturale - cemento - antracite - H 75	728,00	773,00	801,00	840,00	924,00	974,00
■ *solo struttura PIANO CLIENTE - H 73	392,00	403,00	414,00	448,00	470,00	482,00
■ VERNICIATA alluminio	392,00	403,00	414,00	448,00	470,00	482,00
■ VERNICIATA bianca	392,00	403,00	414,00	448,00	470,00	482,00
■ VERNICIATA antracite	392,00	403,00	414,00	448,00	470,00	482,00

LEGENDA SOLO STRUTTURE PER PIANO CLIENTE

■ NORMALMENTE IN PRONTA CONSEGNA

BASE CENTRALE FISSA



Art. 8701TL pag. 85



Art. 8608 pag. 28



Art. 8686 pag. 25



Art. 8715 pag. 30



Art. 8706 pag. 87



Art. 8696 pag. 22

BASE CENTRALE ALLUNGABILE



Art. 8718 allungabile pag. 93
per piano 130x80 aperto 190 (1 allunga)



Art. 8601 allungabile pag. 90
per piano 140x90 aperto 220 (2 allunghe) apertura sincron

Art. 8689 allungabile pag. 89
per piano 160x90 aperto 270 (2 allunghe) carrello traslante



Art. 8704 ME pag. 74



Art. 8704 VE pag. 72

BASI PER PIANO VETRO TRASPARENTE



Art. 8673
pag. 61
Per piani
rettangolari
vetro



Art. 8712 pag. 75



Art. 8615
pag. 128
Per piani
tondi vetro



Tavolino
trasformabile
Art. 8758
pag. 305



Tavolo a muro apribile Art. 8744 pag. 317



Consolle apribile
Art. 8725
pag. 316

STRUTTURE CUCINA / LIVING



Art. 8635 pag. 102
allungabile telescopico, varie misure



Art. 8622 per HPL pag. 96
allungabile telescopico, varie misure



Art. 8663 telaio fisso pag. 108
H 73 / 108 **anche su misura**



Art. 8661 telaio fisso pag. 106
H 73 **anche su misura**



Art. 8619 pag. 100
allungabile telescopico, varie misure



Art. 8626 pag. 98
allungabile telescopico, varie misure



Art. 8635 QD pag. 105
misure 90x90 allungabile



Art. 8665 pag. 104
misure 90x60 allungabile

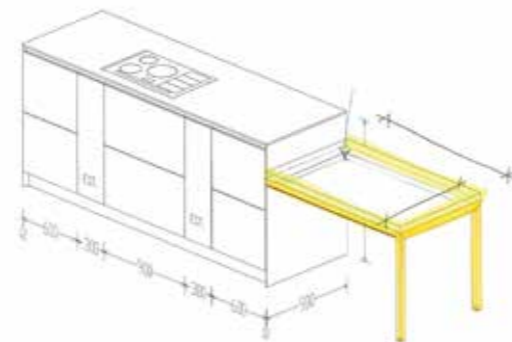

Agganciabile basi cucina
Art. 8619 allungabile telescopico pag. 100
Art. 8663 telaio fisso pag. 108

Basi centrali vedi anche pag. dopo



Art. base Piatta



Art. 81037/D pag. 254

Gamboni per penisola telescopici

Art. 8770
H67/87 - Ø12
bianco - antracite
325,00



Art. 8610 pag. 118

Ø allungabile
o fisso



Art. 8664 Ø diam. 100 allungabile pag. 120



Art. 8620 x HPL Ø 100/120 allungabile pag. 116



marmo bianco liscio

Sedia Art. 8305 vedi pag. 152

Art. 8658 - HPL tondo fisso

COSTO SOLO PIANO, DA SOMMARE CON LA BASE SCELTA

HPL 10 MM
CORPO NERO
marmo bianco liscio
cemento
rovere naturale
bianco unito

HPL 12 MM
COLOR SCURO
grafite
lavagna
ardesia
pietra kaspio (corpo nero)
rovere nodato (corpo marrone)

HPL 12 MM
FULL COLOR
carrara gold
bianco unito unicolor

■ Ø 120	717,00	762,00	963,00
■ Ø 130	930,00	986,00	1.299,00

PIANI HPL + BASE A SCELTA

COLORI HPL 12 MM

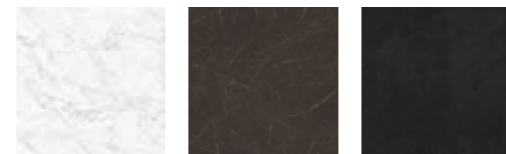

CARRARA GOLD GRAFITE LAVAGNA



ARDESIA PIETRA KASPIO ROVERE NODATO (country oak)

COLORI HPL 10 MM



ROVERE NATURALE 4543 FIN. ALEVE corpo marrone
CEMENTO FIN. PIETRA 3192 FIN. LUNA corpo nero
MARMO BIANCO LISCIO 5547 FIN. OPACA corpo nero
BIANCO UNITO 001 FIN. R. corpo nero

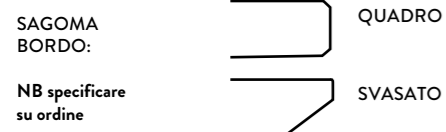

SAGOMA BORDO:

NB specificare su ordine

Dalle misure indicate manca 1 cm.

BASE A SCELTA

Tavolo completo TEMPI 30 GG

Solo strutture NORMALMENTE IN PRONTA CONSEGNA



Art. 81046.LS60 Base Como Ø 60
Nera

302,00



Art. 8641/5
Bianca - Antracite
Ø base 70
foto ambientata pag. 131

571,00



Art. 8611
Bianca - Nera
Ø base 70
foto ambientata pag. 122

773,00



Art. 8681
Nera
Ø base 60
foto ambientata pag. 33

941,00



Art. 8643
Bianca - Nera opaca
Ø base 65
foto ambientate pag. 125

BIANCA 885,00*
NERA OPACA 941,00*



Art. 8620 Base 4G fissa
Nera - Bronzo
foto ambientata pag. 116

437,00

* Compreso compensatori sottopiano H3



Sedia Art. 8304 vedi pag. 154

Struttura bronzo / Piano pietra kaspio

Art. 8620 - HPL tondo allungabile con barre acciaio integrate (per evitare eventuali curvature)

Tavolo completo TEMPI 30 GG

Solo strutture **NORMALMENTE IN PRONTA CONSEGNA**

- ALLUMINIO verniciato: nero - bronzo
- HPL 10 mm/corpo nero: carrara gold
- HPL 12 mm/corpo scuro: grafite - lavagna - ardesia - pietra kaspio - rovere nodato

■ MISURE: Ø 100 aperto 180 (2 allunghe da 40) - H 76 **1.557,00**

■ MISURE: Ø 120 aperto 200 (2 allunghe da 40) - H 76 **2.007,00**

SOLO BASE piano cliente

- SOLO GAMBE PER PIANO FISSO **437,00**
- GAMBE + GUIDE **885,00**



CARRARA
GOLD
10 MM



GRAFITE
12 MM



LAVAGNA
12 MM

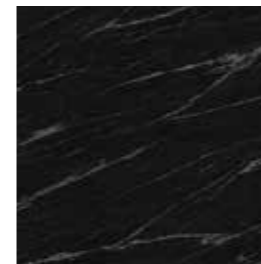

ARDESIA
12 MM



PIETRA KASPIO
12 MM



ROVERE NODATO
12 MM



Sedia Art. 8305 vedi pag. 152

Struttura nera





rovere nodato

■ STRUTTURA METALLO VERNICIATO NERA

■ **NORMALMENTE IN PRONTA CONSEGNA**

Art. 8610/1

■ MISURE: Ø 120 aperto 220 (2 allunghe da 50) - H 76

■ NOBILITATO 25 mm:

rovere nodato - cemento - antracite - pietra grey 1.546,00

SOLO BASE piano cliente

■ SOLO GAMBE PER PIANO FISSO

650,00

■ GAMBE + GUIDE (High Quality a sfere)

1.075,00



Ø 120 aperto 220 (2 allunghe da 50)

MODELLO DEPOSITATO



rovere nodato

cemento

antracite

pietra grey

Art. 8610/2

■ MISURE: Ø 120 aperto 370 (5 allunghe da 50) - H 76

■ NOBILITATO 25 mm:

rovere nodato - cemento - antracite - pietra grey 2.005,00

SOLO BASE piano cliente

■ SOLO GAMBE PER PIANO FISSO

650,00

■ GAMBE + GUIDE con gamba di sostegno a scomparsa

1.277,00

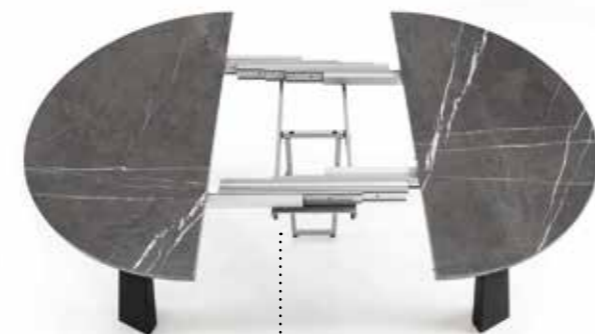

Ø 120 aperto 370 (5 allunghe da 50)

gamba di sostegno a scomparsa



cemento



antracite (spalmato ardesia)



pietra grey

da Ø 120 allungabile 220 o **370** cm



Carrello portallunghe Art. 8752

■ **NORMALMENTE IN PRONTA CONSEGNA**

■ NOBILITATO BIANCO PORO APERTO

MISURE: 57 x 18 x H 60

222,00

contiene 5 allunghe





Sedia Art. 803 vedi pag. 212

Art. 8664

■ **NORMALMENTE IN PRONTA CONSEGNA**

■ **MISURE: Ø 100 aperto 200**
(2 allunghe da 50 da ricoverare) - H 76

■ **BASE ACCIAIO VERNICIATA NERA**

■ **NOBILITATO 19 mm:**
rovere nodato - cemento - antracite - pietra grey **1.333,00**

■ **SOLO BASE** piano cliente (GAMBE + GUIDE) **773,00**



rovere nodato



cemento



antracite

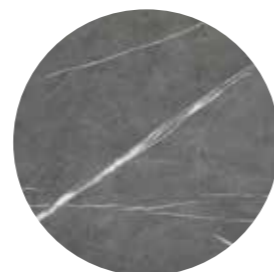

pietra grey

Il tavolo Ø piccolo
..... e allungabile

Sedia Art. 8042 € 143,00
polipropilene: bianca - nera - ottanio





Sedia Art. 8253/4G vedi pag. 147



Sedia Art. 8304 vedi pag. 154



bordo svasato - top 30 mm

Art. 8611

■ **NORMALMENTE IN PRONTA CONSEGNA**

■ **LAMINATO SPESSORE 30 mm - BORDO SVASATO**
- Ø 120 fisso (max 6 persone) H 77

laminato **BIANCO OPACO** 1.288,00

laminato **ROVERE MATERICO** 1.445,00

■ **VETRO TEMPERATO TRASPARENTE 10 mm - H 76**

- Ø 140 fisso (max 8 persone) 1.669,00

■ **CERAMICA LUCIDA SASSUOLO:**

Ø 120 **BIANCO CALACATTA ORO** 1.994,00

Ø 120 **GREY STONE** 1.994,00

Ø 120 **NERO THUNDER NIGHT** 1.994,00

Ø 140 **BIANCO CALACATTA ORO** 2.386,00

Ø 140 **NERO THUNDER NIGHT** 2.386,00

In fase d'ordine specificare colore della base

■ **BASE ACCIAIO VERNICIATA: nera - bianca**

solo base Ø 69 - H 72,5 - piano cliente **legno** 773,00



Sedia Art. 8210 Unicolor vedi pag. 148

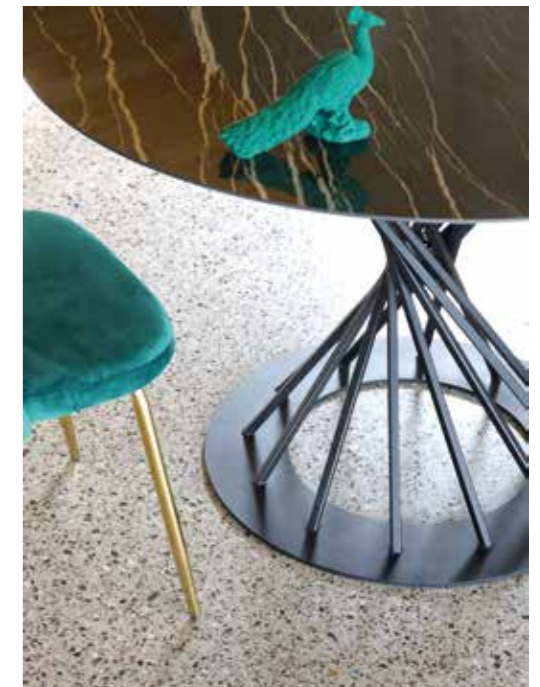



Sedia Art. 8206 vedi pag. 161



Sedia Art. 8210 vedi pag. 148



Art. 8640

■ **NORMALMENTE IN PRONTA CONSEGNA**

■ PIANO **CERAMICA LUCIDA SASSUOLO:**
SPESSORE 6 MM + 18 MM NOBILITATO H 76

■ MISURE:

Ø 120 **BASE BIANCA** 2.206,00
BIANCO CALACATTA ORO - THUNDER NIGHT - GREY STONE

Ø 120 **BASE NERA OPACA** 2.274,00
BIANCO CALACATTA ORO - THUNDER NIGHT - GREY STONE

Ø 140 **BASE BIANCA** 2.598,00
BIANCO CALACATTA ORO - THUNDER NIGHT

Ø 140 **BASE NERA OPACA** 2.666,00
BIANCO CALACATTA ORO - THUNDER NIGHT

■ SOLO BASE (PIANO CLIENTE) - Ø 65 - H 71 Art. 8643

BIANCA 829,00

NERA OPACA 885,00

supplemento per sottopiano H3 cm nobilitato bianco 56,00



* APERTURA SINCRO
(aprendo da una parte si apre automaticamente dall'altra)

Art. 8643 Rovere

■ **NORMALMENTE IN PRONTA CONSEGNA**

■ PIANO H 77 LAMINATO PLACCATO **ROVERE MATERICO**
SPESSORE 30 MM - BORDO SVASATO MDF

- Ø 120 **fisso** (max 6 persone)

- Ø 120 **aperto 170** allunga da ricoverare a parte (max 8 persone)

■ **BASE ACCIAIO VERNICIATA bianca** - solo base Ø 65 - H 71 piano cliente

■ **BASE ACCIAIO VERNICIATA nera opaca** - solo base Ø 65 - H 71 piano cliente



poltroncina Art. 8249 - 440,00
ecopelle: bianca - nera (base girevole in tinta)

Tavolo Art. 8643 **Black/White**
vedi pag. dopo

BASE BIANCA BASE NERA

1.613,00 **1.669,00**

2.173,00 **2.229,00**



829,00 (supplemento per sottopiano H3 cm **56,00**)

885,00 (supplemento per sottopiano H3 cm **56,00**)

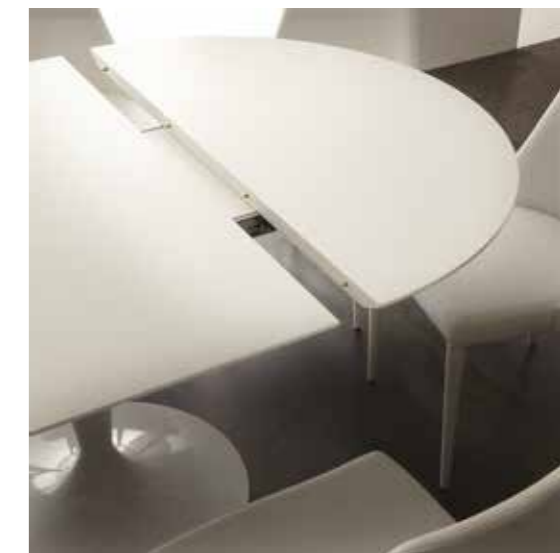

piano e bordo laccato

Poltroncina Art. 8248

- IMBALLO N. 1 pz.
 - **NORMALMENTE IN PRONTA CONSEGNA**
 - STRUTTURA GIREVOLE ACCIAIO VERNICIATA **bianca**
 - SEDILE GIREVOLE - ALTEZZA FISSA
- ECOPELLE: **bianco - sabbia - titanio** **433,00**

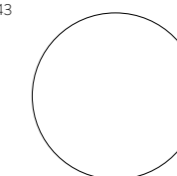
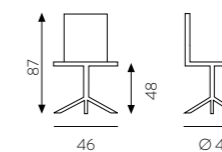

bianco



sabbia

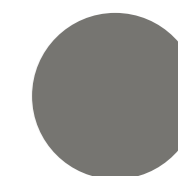

grigio titanio

Tavolo Art. 8643 Black/White

- **NORMALMENTE IN PRONTA CONSEGNA**

*APERTURA SINCRO
(aprendo da una parte si apre automaticamente dall'altra)

- BASE ACCIAIO VERNICIATO - Ø 65 - H 71

prezzo solo base, piano cliente: **bianca 829,00**
nera opaca 885,00

(adatta anche per piani marmo, piattello spessore sottopiano, 3 cm **56,00**)

- LACCATO BIANCO AL QUARZO (ALTA RESISTENZA) - SPESSORE 30 MM - BORDO SVASATO - PIANO H 77

- Ø 120 aperto 170* allunga da ricoverare a parte (max 8 persone) **2.173,00**

- LACCATO NERO AL QUARZO (ALTA RESISTENZA) - SPESSORE 30 MM - BORDO SVASATO - PIANO H 77

- Ø 120 aperto 170* allunga da ricoverare a parte (max 8 persone) **2.229,00**

- PIANO H 77 LAMINATO BIANCO - SPES. 30 MM - BORDO SVASATO

- Ø 120 fisso (max 6 persone) **1.669,00**

- Ø 110 fisso (max 5 persone) **1.646,00**

- Ø 100 fisso (max 4 persone) **1.624,00**



piano e bordo laminato



Sedia Art. 8240 vedi pag. 150



Art. 8615

- **NORMALMENTE IN PRONTA CONSEGNA**
- BASE FAGGIO MASSELLO
PIANO VETRO TEMPERATO 10 mm TRASPARENTE - H 76
IN APPOGGIO
- Ø 120/base tinta GRAFITE 1.165,00
- Ø 140/base tinta GRAFITE 1.221,00
- Ø 120/base LACCATA BIANCA 1.165,00
- Ø 140/base LACCATA BIANCA 1.221,00
- solo base piano cliente tinta GRAFITE 661,00
- solo base piano cliente LACCATA BIANCA 661,00

N.B.
MAX PIANO Ø 140 CM - 50 KG

Sedia Art. 8304 vedi pag. 154



Sedia Art. 8240 vedi pag. 150



Sedia Art. 808
vedi pag. 241



Art. 8618

- **NORMALMENTE IN PRONTA CONSEGNA**
- BASE ACCIAIO VERNICIATA BIANCA
PIANO VETRO TEMPERATO EXTRAWHITE 10 MM - H 75
- MISURE:
ellittico 110 x 160 2.206,00
Ø 130 2.206,00
- PER DIMENSIONI PIÙ PICCOLE VEDI ART. 8641/2 PAG. 130

Sedia Art. 8290 vedi pag. 211



portavivande girevole

Art. 81821/12

■ **NORMALMENTE IN PRONTA CONSEGNA**

■ VERO MASSELLO DI TEAK INDONESIANO
CON FINITURA OLIO NATURALE

■ MISURE: Ø 150 (8 persone) - H 75 2.106,00

■ MISURE: Ø 180 (10 persone) - H 75 2.531,00

ADATTO ANCHE PER OUTDOOR



Sedia Art. 8379 vedi pag. 142



Sedia eliminata

Art. 8646/2

■ MISURE: Ø 120 aperto 160 - H 78

■ BASE FAGGIO MASSELLO/ PIANO IMPIALLACCIATO TANGANICA

■ laccato bianco 1.870,00
 ■ noce scuro verniciato a mano 1.870,00
 ■ grezzo 1.086,00



Art. 8680

■ **NORMALMENTE IN PRONTA CONSEGNA**

■ MISURE: 130 x 85 aperto 170/210 - H 78

■ BASE FAGGIO TINTO NOCE SCURO
PIANO IMPIALLACCIATO TANGANICA
TINTO NOCE SCURO

773,00

Sedia Art. 8133 vedi pag. 252



Art. 8398/1 Poltrona

- MISURE L 67 | P 72 | H 40/77
- STRUTTURA METALLO VERNICIATA NERA
- **NORMALMENTE IN PRONTA CONSEGNA**
- TESSUTO GRIGIO DI SERIE **582,00**
- **CUSTOM - TEMPI 40 GG**
- STOFFA CLIENTE - TAP. LA SEGGIOLA (2 MT) **1.109,00**

Art. 8398/2 Divanetto

- MISURE L 125 | P 72 | H 40/78
- STRUTTURA METALLO VERNICIATA NERA
- **NORMALMENTE IN PRONTA CONSEGNA**
- TESSUTO GRIGIO DI SERIE **948,00**
- **CUSTOM - TEMPI 40 GG**
- STOFFA CLIENTE - TAP. LA SEGGIOLA (3 MT) **1.328,00**

Art. 8398/3 Pouf

- MISURE L 42 | P 42 | H 47
- STRUTTURA METALLO VERNICIATA NERA
- **NORMALMENTE IN PRONTA CONSEGNA**
- TESSUTO GRIGIO DI SERIE **213,00**
- **CUSTOM - TEMPI 40 GG**
- STOFFA CLIENTE - TAP. LA SEGGIOLA (1,5 MT) **482,00**





Sgabello poggiapiedi 8507
pag. 290

Art. 8388

- IMBALLO N. 1 pz.
- **NORMALMENTE IN PRONTA CONSEGNA**
- STRUTTURA METALLO CROMATO/ FAGGIO NATURALE
- SEDILE SINTETICO SOFT grigio SFODERABILE **666,00**

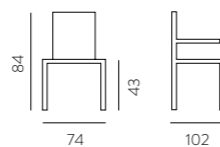

Art. 8390

- IMBALLO N. 2 pz.
Imballo speciale 1 pz. + 10,00 netto
- **NORMALMENTE IN PRONTA CONSEGNA**
- STRUTTURA METALLO CROMATO
- SEDILE SINTETICO SOFT grigio SFODERABILE **538,00**

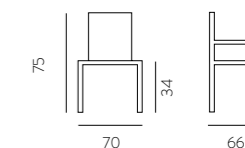
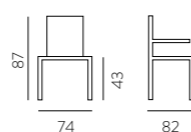

Art. 8394

- IMBALLO N. 1 pz.
- **NORMALMENTE IN PRONTA CONSEGNA**
- GAMBE MASSELLO DI FAGGIO TINTO NATURALE
STRUTTURA POLIPROPILENE
- PP BIANCO / TESSUTO GRIGIO **446,00**
- PP GRIGIO / TESSUTO GRIGIO **446,00**
- PP CELESTE / TESSUTO CELESTE **446,00**



Art. 8396

- IMBALLO N. 1 pz.
- **NORMALMENTE IN PRONTA CONSEGNA**
- GAMBE MASSELLO DI FAGGIO TINTO NATURALE
- TESSUTO GRIGIO **219,00**
- TESSUTO CELESTE **219,00**

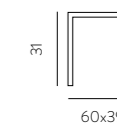



ROTAZIONE A 180°
CON MECCANISMO DI
RITORNO AUTOMATICO

Art. 8265 - base twist

- IMBALLO N. 2 pz.
Imballo speciale 1 pz. + 10,00 netto
- **NORMALMENTE IN PRONTA CONSEGNA**
DISPONIBILE DA MAGGIO 2025
- BASE 4 GAMBE VERNICIATA NERA
- TESSUTO ANTIMACCHIA: tortora - antracite

323,00



Art. 8264 - 4 gambe

- IMBALLO N. 2 pz.
Imballo speciale 1 pz. + 10,00 netto
- **NORMALMENTE IN PRONTA CONSEGNA**
- BASE 4 GAMBE VERNICIATA NERA
- TESSUTO ANTIMACCHIA: tortora - salvia - mandarino - antracite
- Stoffa cliente (1,5 mt) TEMPI 30/50 gg.

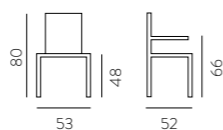

289,00
334,00





Art. 8211/4G

- IMBALLO N. 1 pz.
- **NORMALMENTE IN PRONTA CONSEGNA**
- BASE 4 GAMBE VERNICIATA NERA
- ECOPELLE: tortora fango - titanio **378,00**
- VELLUTO ANTIMACCHIA grigio cenere **378,00**
- Stoffa cliente (1,5 mt) TEMPI 40 gg. **402,00**

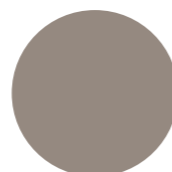
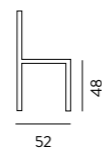
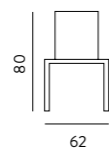

tortora fango

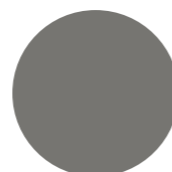

grigio titanio



grigio cenere



Art. 8260

- IMBALLO N. 2 pz.
Imballo speciale 1 pz. + 10,00 netto
- **NORMALMENTE IN PRONTA CONSEGNA**
- STRUTTURA METALLO
VERNICIATA **NERA**
- Velluto a coste antracite **309,00**

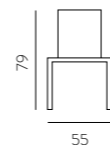



■ **IMBALLO N. 2 pz.**
 Imballo speciale 1 pz. + 10,00 netto

■ **NORMALMENTE IN PRONTA CONSEGNA**

■ **STRUTTURA METALLO VERNICIATA NERA**

Art. **8379**

■ **VELLUTO ANTIMACCHIA:** tortora - antracite - verde

276,00

Art. **8377**

■ **TESSUTO GREEN ANTIMACCHIA:** tortora - salvia - mandarino - antracite

276,00

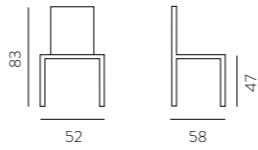

Il velluto potrebbe presentare effetti che non sono da considerare difettosità in quanto caratteristiche della composizione e del tipo di lavorazione: effetto a macchia o marazzatura, effetto chiaro/scuro, effetto impronta

VELLUTO ANTIMACCHIA



TESSUTO ANTIMACCHIA





semipoltronicina CUSTOM Art. 8380

- **TEMPI 30 GG.**
- STRUTTURA METALLO VERNICIATA **NERA** --- SUPPLEMENTO **BRONZO + € 14,00**
- Velluto: **giallo - mattone - rosa - ottanio - verde**
- Stoffa cliente (1,5 mt) TEMPI 40 gg.

314,00
246,00

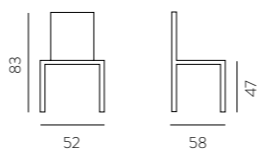

poltronicina CUSTOM Art. 8381

- **IMBALLO N. 1 pz.**
- **TEMPI 30 GG.**
- STRUTTURA METALLO VERNICIATA **NERA**
SUPPLEMENTO **BRONZO + € 14,00**
- Velluto: **giallo - mattone - rosa - ottanio - verde** 330,00
- Ecopelle: **cuoio - nera** 342,00
- Stoffa cliente (1,5 mt) TEMPI 40 gg. 263,00

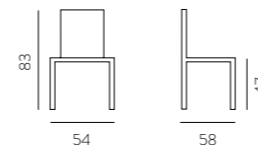



Art. 8252

- **IMBALLO N. 2 pz.**
Imballo speciale 1 pz. + 10,00 netto

- **NORMALMENTE IN PRONTA CONSEGNA**

- STRUTTURA METALLO VERNICIATA NERA

- **SEDILI (no girevole) ECO NABUK grigio** 242,00

- **SEDILI (no girevole) scottish** Art. 8252 CUSTOM 391,00

retro tessuto scozzese / velluto antimacchia tortora TEMPI 40 gg.

- **Stoffa cliente (1,5 mt) TEMPI 40 gg.** 391,00

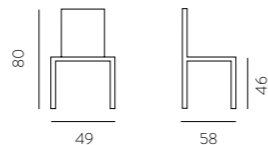

eco nabuk GRIGIO



Art. 8253/4G

- **IMBALLO N. 2 pz.**
Imballo speciale 1 pz. + 10,00 netto
- **NORMALMENTE IN PRONTA CONSEGNA**

- **BASE 4 GAMBE VERNICIATA NERA**

- **ECOPELLE: tortora fango - titanio** 242,00

- **VELLUTO ANTIMACCHIA grigio cenere** 242,00

- **Stoffa cliente (1,5 mt) TEMPI 40 gg.** 311,00

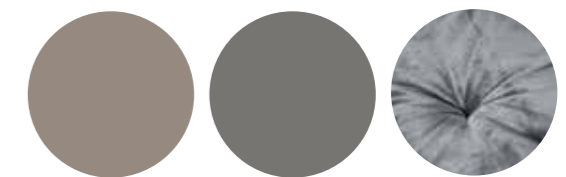
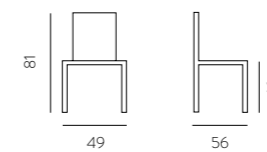

tortora fango

grigio titanio

grigio cenere

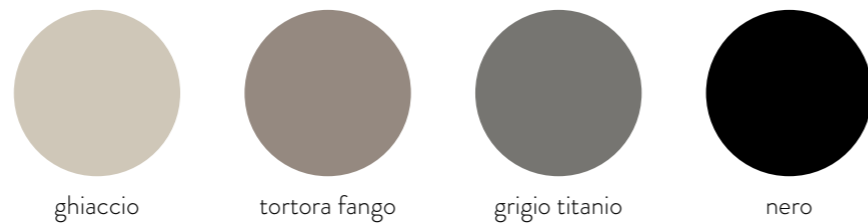
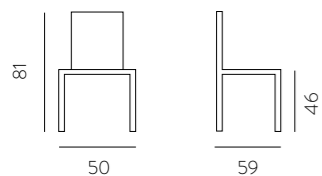

Art. 8210 unicolor

- **IMBALLO N. 2 pz.**
Imballo speciale 1 pz. + 10,00 netto
- **NORMALMENTE IN PRONTA CONSEGNA**
- **STRUTTURA METALLO VERNICIATA IN TINTA**
- **SEDILI ECOPELLE UNICOLOR: ghiaccio - tortora fango - titanio - nera** **255,00**
- **STRUTTURA METALLO VERNICIATA NERA**
- **SEDILI STOFFA CLIENTE (1,5 MT.) TEMPI 40 gg.** **297,00**



Art. 8210 nabuk

- **IMBALLO N. 2 pz.**
Imballo speciale 1 pz. + 10,00 netto
- **NORMALMENTE IN PRONTA CONSEGNA**
- **STRUTTURA METALLO VERNICIATA NERA**
- **SEDILI ECOPELLE NABUK: beige - grigio** **255,00**
- **STOFFA CLIENTE (1,5 MT.) TEMPI 40 gg.** **297,00**



suo sgabello
vedi pag. 278



Art. 8240

- IMBALLO N. 4 pz.
Imballo speciale 1/3 pz. + 10,00 netto
- **NORMALMENTE IN PRONTA CONSEGNA**
- STRUTTURA METALLO
- GAMBE RIVESTITE ECOPELLE: bianco-sabbia
- GAMBE VERNICIATE IN TINTA / ECOPELLE titanio



sgabello vedi pag. 279



222,00
222,00

CUSTOM - TEMPI 40 GG

- GAMBE VERNICIATE NERE / VELLUTO VEDI SOTTO
- GAMBE VERNICIATE NERE / **STOFFA CLIENTE** (1,5 MT.)

337,00
300,00

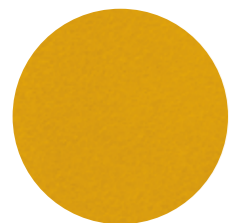
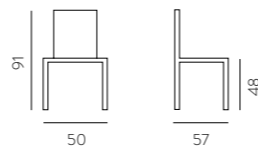

24 giallo

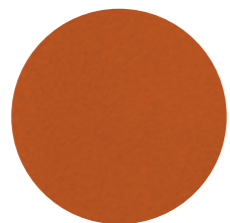

26 mattone

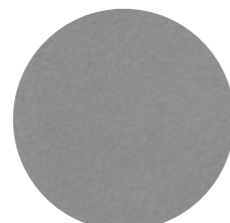

10 grigio fumo

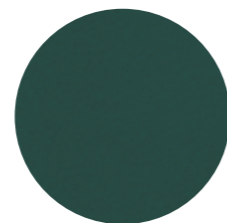

19 ottanio

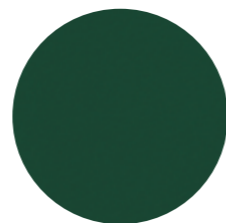

20 verde





Art. 8305

- **IMBALLO N. 4 pz.**

Imballo speciale 1/3 pz. + 10,00 netto

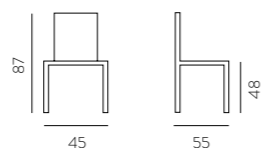

- **NORMALMENTE IN PRONTA CONSEGNA**

- **STRUTTURA METALLO VERNICIATA**

- **VELLUTO ANTIMACCHIA:**

nero / gambe nere puntale verniciato ottone 130,00

antracite / gambe nere puntale verniciato silver 130,00

**nero - tortora - ottanio - mattone - verde bosco /
gambe tutte nere 130,00**

- **STOFFA CLIENTE (1,4 MT.) + € 58,00 TEMPI 40 gg.**





Art. 8304

■ **IMBALLO N. 4 pz.**

Imballo speciale 1/3 pz. + 10,00 netto

■ **NORMALMENTE IN PRONTA CONSEGNA**

■ **VELLUTO:**

nero - antracite - grigio perla - verde bosco - rosa cipria
tortora - ottanio - mattone

■ **STOFFA CLIENTE (1,5 MT.) + € 58,00 TEMPI 40 gg.**

■ **GAMBE VERNICIATE NERE 186,00**

■ **GAMBE OTTONE LUCIDO galvanico 199,00**

■ **GAMBE VERNICIATE BRONZO 199,00**

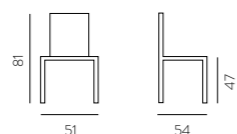

gamba Ø 22 conificata



Sgabello Art. 8506 vedi pag. 274



cucitura con PIPING

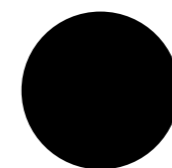

nero

NEWS



antracite



grigio perla



mattone



ottanio



rosa cipria



verde bosco



tortora

Il velluto potrebbe presentare effetti che non sono da considerare difettosità in quanto caratteristiche della composizione e del tipo di lavorazione: effetto a macchia o marazzatura, effetto chiaro/scuro, effetto impronta





Art. 8306

■ **IMBALLO N. 4 pz.**

Imballo speciale 1/3 pz. + 10,00 netto

■ **NORMALMENTE IN PRONTA CONSEGNA**

■ **VELLUTO:** antracite - verde bosco - rosa cipria

■ **GAMBE VERNICIATE NERE** **178,00**

gamba Ø 25 conifcata

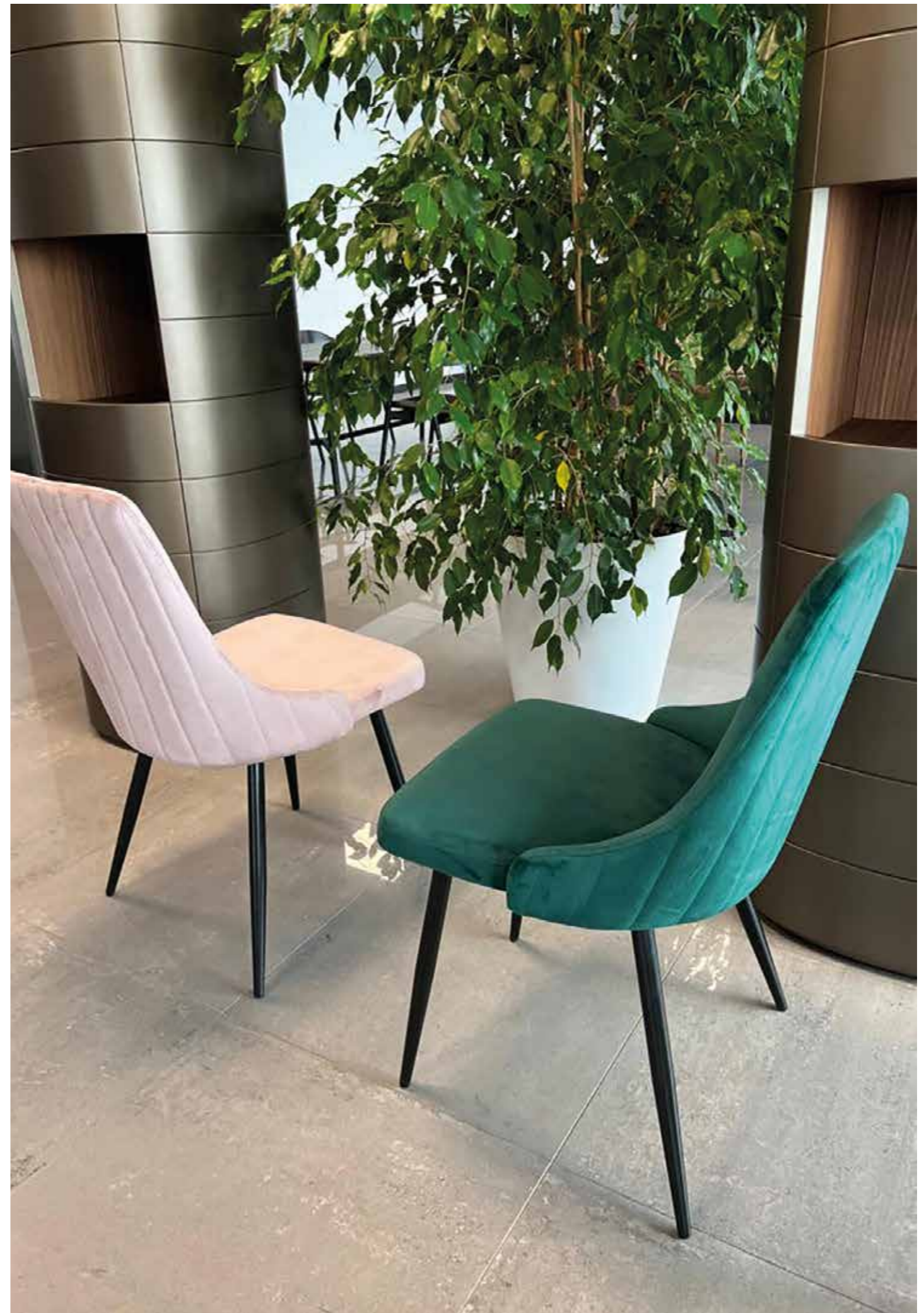
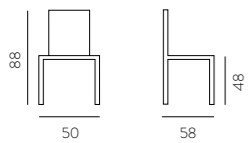

Il velluto potrebbe presentare effetti che non sono da considerare difettosità in quanto caratteristiche della composizione e del tipo di lavorazione: effetto a macchia o marazzatura, effetto chiaro/scuro, effetto impronta

Art. 8270

■ **IMBALLO N. 4 pz.**

Imballo speciale 1/3 pz. + 10,00 netto

■ **NORMALMENTE IN PRONTA CONSEGNA**

■ **STRUTTURA METALLO VERNICIATA NERA**

■ **TESSUTO GREEN ANTIMACCHIA:** 186,00
tortora - antracite

■ **STOFFA CLIENTE (1,5 MT.) TEMPI 40 gg.** 244,00

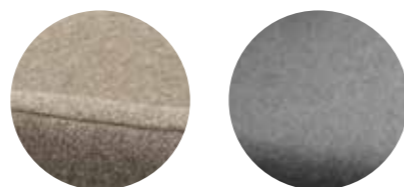
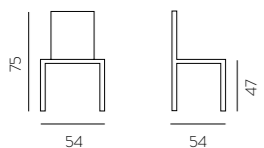

tortora

antracite



Sgabello
Art. 8509/6
vedi pag. 269





Art. 8206

- **IMBALLO N. 4 pz.**
 Imballo speciale 1/3 pz. + 10,00 netto
- **NORMALMENTE IN PRONTA CONSEGNA**
- **STRUTTURA METALLO VERNICIATA NERA**
- **VELLUTO ANTIMACCHIA:** 222,00
 tortora - antracite - grigio cenere
 celeste - zafferano - mattone
- **STOFFA CLIENTE (1,5 MT.) TEMPI 40 gg.** 244,00

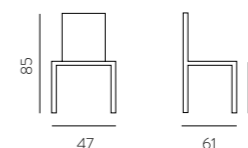

Il velluto potrebbe presentare effetti che non sono da considerare difettosità in quanto caratteristiche della composizione e del tipo di lavorazione:
 effetto a macchia o marazzatura, effetto chiaro/scuro, effetto impronta



tortora



antracite

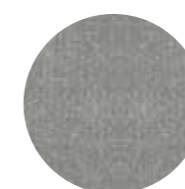

grigio cenere

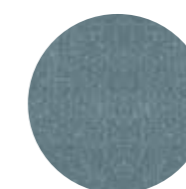

celeste



zafferano



mattone



Art. 8282

- **IMBALLO N. 3 pz.**
Imballo speciale 1/2 pz. + 10,00 netto
- **NORMALMENTE IN PRONTA CONSEGNA**
- **STRUTTURA METALLO VERNICIATA NERA**
- **VELLUTO ANTIMACCHIA:** 219,00
 blu petrolio - grigio fumo
 giallo senape - tortora

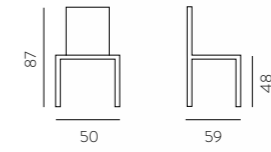

Il velluto potrebbe presentare effetti che non sono da considerare difettosità in quanto caratteristiche della composizione e del tipo di lavorazione:
 effetto a macchia o marazzatura, effetto chiaro/scuro, effetto impronta

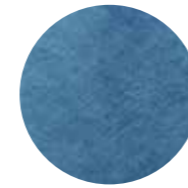

blu petrolio



grigio fumo



giallo senape



tortora





Art. 8209

- **IMBALLO N. 2 pz.**
Imballo speciale 1 pz. + 10,00 netto
- **NORMALMENTE IN PRONTA CONSEGNA**
- **STRUTTURA METALLO VERNICIATA NERA**
- **ECOPELLE:**
ottanio - titanio 267,00
- **VELLUTO ANTIMACCHIA:**
sabbia - grigio fumo - verde 267,00

Il velluto potrebbe presentare effetti che non sono da considerare difettosità in quanto caratteristiche della composizione e del tipo di lavorazione:
effetto a macchia o marazzatura, effetto chiaro/scuro, effetto impronta

L'ecopelle nei colori chiari potrebbe macchiarsi a contatto con indumenti non trattati (es. jeans). Per la pulizia dei prodotti utilizzare solo acqua tiepida e un panno morbido in microfibra.
Non usare solventi o prodotti aggressivi.

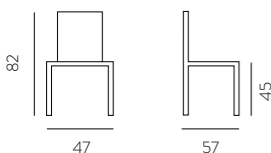



Art. 8100

■ IMBALLO N. 2 pz.
Imballo speciale 1 pz. + 10,00 netto

■ **NORMALMENTE IN PRONTA CONSEGNA**

■ BASE 4 GAMBE VERNICIATA NERA

■ ECOPELLE, SEDILE LISCIA / SCHIENALE STAMPATO A RILIEVO:

tortora chiaro - nocciola - titanio

278,00

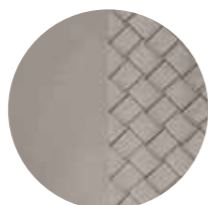
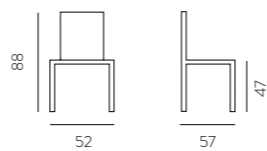

tortora chiaro

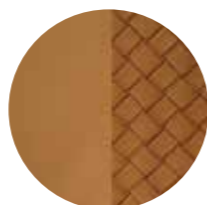

nocciola

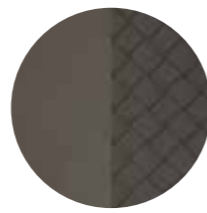

grigio titanio





Art. 8208

■ **IMBALLO N. 4 pz.**

Imballo speciale 1/3 pz. + 10,00 netto

■ **NORMALMENTE IN PRONTA CONSEGNA**

■ **STRUTTURA METALLO VERNICIATA NERA / PIEDINO OTTONE SATINATO**

■ **VELLUTO ANTIMACCHIA:**

sabbia - grigio fumo 276,00

verde bosco - mattone - zafferano 323,00

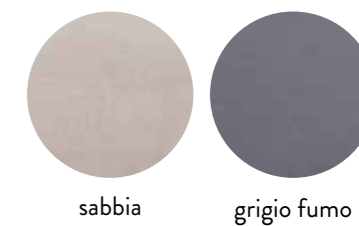
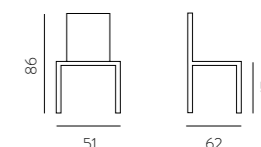

■ **STOFFA CLIENTE (1,5 MT.)**

TEMPI 40 gg.

SEDIA Art. 8208 358,00

SGABELLO
H 65 Art. 8568/6 390,00

H 75 Art. 8568/7 401,00

Sgabello Art. 8568
pag. 272



Art. 8217

■ **IMBALLO N. 2 pz.**
 Imballo speciale 1 pz. + 10,00 netto

■ **NORMALMENTE IN PRONTA CONSEGNA**

■ **NERO/VELLUTO 255,00**
 accessorio piedino ottone H 8 cm + € 40,00 set 4 pz.

■ **OTTONE/VELLUTO 363,00**
 ottone lucido a bagno galvanico "MADE IN ITALY"

VELLUTO COLORATO:
 grigio fumo - tortora - senape - arancio - blu - verde

■ **STOFFA CLIENTE (1 MT.) + € 88,00 TEMPI 40 gg.**

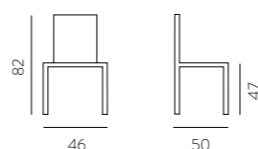

accessorio piedino ottone



sgabello vedi pag. 275



Art. 8266

- **IMBALLO N. 2 pz.**
Imballo speciale 1 pz. + 10,00 netto
- **NORMALMENTE IN PRONTA CONSEGNA**
- **STRUTTURA METALLO VERNICIATA NERA**
- **TESSUTO ANTIMACCHIA:** 255,00
tortora - salvia - mandarino - antracite

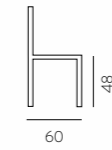
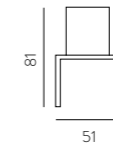

Sgabello
Art. 8566/6
vedi pag. 277

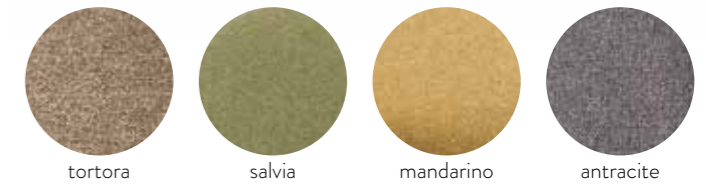



Sgabello Art. 8582
vedi pag. 276

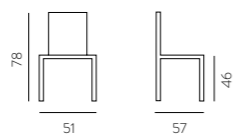

Art. 8382

- IMBALLO N. 2 pz.
- **NORMALMENTE IN PRONTA CONSEGNA**
- STRUTTURA METALLO VERNICIATA NERO LAMBORGHINI **264,00**
- VELLUTO ANTIMACCHIA:
grigio fumo - celeste - rosa - verde - ottanio - mattone - giallo

Il velluto potrebbe presentare effetti che non sono da considerare difettosità in quanto caratteristiche della composizione e del tipo di lavorazione: effetto a macchia o marazzatura, effetto chiaro/scuro, effetto impronta

- STOFFA CLIENTE (1,5 MT.) + € 117,00 TEMPI 40 gg.



Art. 8234



- IMBALLO N. 4 pz.
Imballo speciale 1/3 pz. + 10,00 netto

■ **NORMALMENTE IN PRONTA CONSEGNA**

■ STRUTTURA ECOPELLE IN TINTA

■ SEDILI ECOPELLE:
bianco - tortora chiaro - tortora fango - titanio

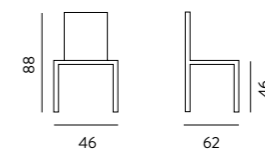

212,00

sgabello - pag. 268





Art. 8235

- **IMBALLO N. 4 pz.**
Imballo speciale 1/3 pz. + 10,00 netto
- **NORMALMENTE IN PRONTA CONSEGNA**
- **STRUTTURA VERNICIATA NERA**
- **VELLUTO ANTIMACCHIA:**
grigio antracite - verde bosco - mattone - tortora - ottanio

222,00

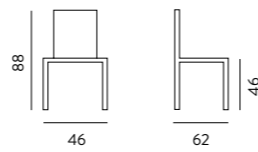



Art. 8215

■ **IMBALLO N. 4 pz.**
 Imballo speciale 1/3 pz. + 10,00 netto

■ **NORMALMENTE IN PRONTA CONSEGNA**

■ **STRUTTURA VERNICIATA NERA**

■ **SEDILI**

ECOPELLE titanio

209,00

VELLUTO ANTIMACCHIA:

grigio fumo - tortora - verde - ottanio - blu

209,00

Il velluto potrebbe presentare effetti che non sono da considerare difettosità in quanto caratteristiche della composizione e del tipo di lavorazione: effetto a macchia o marazzatura, effetto chiaro/scuro, effetto impronta

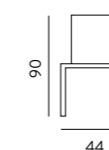

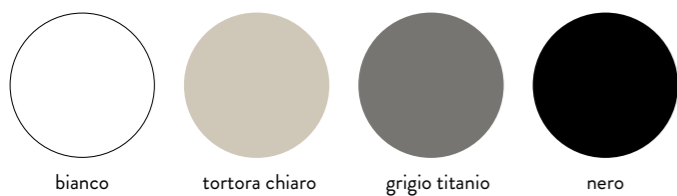

bianco

tortora chiaro

grigio titanio

nero

L'ecopelle nei colori chiari potrebbe macchiarsi a contatto con indumenti non trattati (es. jeans).
Per la pulizia dei prodotti utilizzare solo acqua tiepida e un panno morbido in microfibra. Non usare
solventi o prodotti aggressivi.

Art. 8213

- IMBALLO N. 4 pz.
Imballo speciale 1/3 pz. + 10,00 netto

- **NORMALMENTE IN PRONTA CONSEGNA**

■ STRUTTURA:	ECOPELLE IN TINTA	VERNICIATA IN TINTA
■ SEDILI		
ECOPELLE: bianco - nero	-	187,00
ECOPELLE: tortora chiaro - grigio titanio	187,00	-

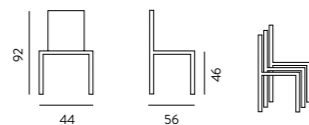



**ECONABUK
FAST CLEAN IDROREPELENTE**

Potrebbe presentare effetti che non sono da considerare difettosità in quanto caratteristiche della composizione e del tipo di lavorazione: effetto a macchia o marazzatura, effetto chiaro/scuro, effetto impronta

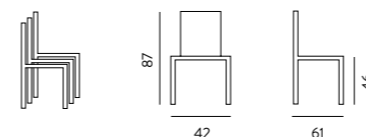

SCARICA QR
PER LE INCREDIBILI
PERFORMANCE

**ECONABUK
FAST CLEAN IDROREPELENTE**



Art. 8219

- IMBALLO N. 4 pz.
Imballo speciale 1/3 pz. + 10,00 netto
- **NORMALMENTE IN PRONTA CONSEGNA**
- STRUTTURA METALLO RICOPERTA
- **ECONABUK FAST CLEAN:** antracite - ghiaccio - tortora - kiwi - mattone - senape - celeste

199,00



Art. 8216

■ **IMBALLO N. 4 pz.**
 Imballo speciale 1/3 pz. + 10,00 netto

■ **NORMALMENTE IN PRONTA CONSEGNA**

■ **STRUTTURA:**

■ **SEDILI**
 ECOPELLE: bianco - tortora chiaro - tortora fango - nero

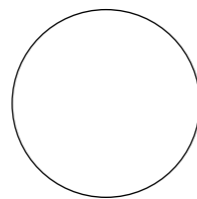

bianco



tortora chiaro

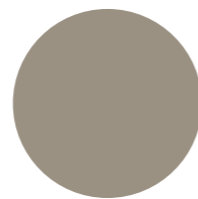

tortora fango

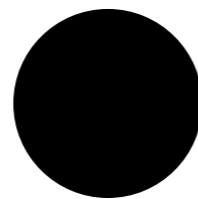

nero

ECOPELLE IN TINTA

175,00

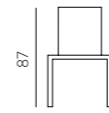

87

43



46

56

L'ecopelle nei colori chiari potrebbe macchiarsi a contatto con indumenti non trattati (es. jeans).
 Per la pulizia dei prodotti utilizzare solo acqua tiepida e un panno morbido in microfibra.
 Non usare solventi o prodotti aggressivi.



GAMBE METALLO
IN TINTA

Art. 8220

■ **IMBALLO N. 4 pz.**

Imballo speciale 1/3 pz. + 10,00 netto

■ **NORMALMENTE IN PRONTA CONSEGNA**

■ **STRUTTURA METALLO VERNICIATA IN TINTA**

■ **SEDILI ECOPELLE:**

tortora chiaro - tortora fango - titanio

183,00

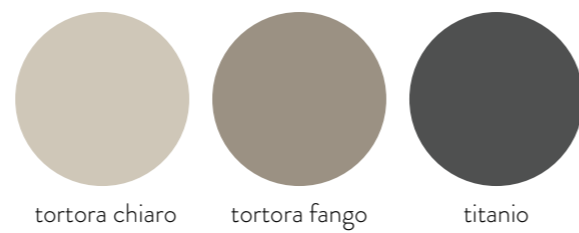

tortora chiaro

tortora fango

titanio

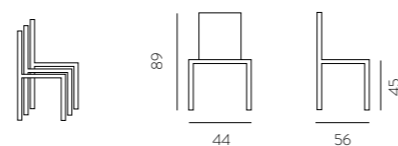

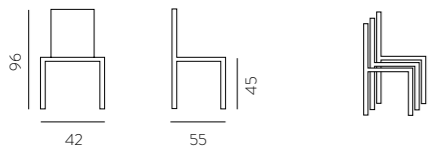

Art. 8232

- **IMBALLO N. 4 pz.**
Imballo speciale 1/3 pz. + 10,00 netto
- **NORMALMENTE IN PRONTA CONSEGNA**
- **STRUTTURA METALLO RIVESTITO**
- **SEDILI**
SIMILCUOIO PVC:
bianco - nero - titanio - sabbia
177,00

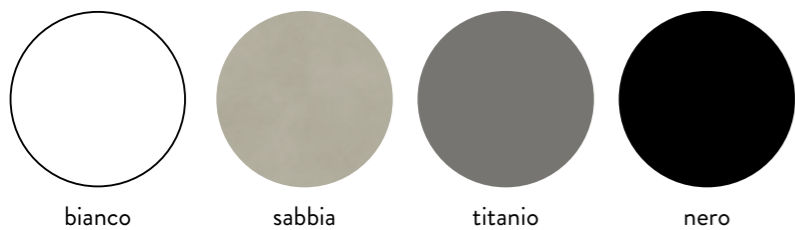

sgabello Art. 8579
pag. 280



con cordino piping

Art. 8119

- **IMBALLO N. 2 pz.**
Imballo speciale 1 pz. + 10,00 netto
- **NORMALMENTE IN PRONTA CONSEGNA**
- **TESSUTO NIVES ANTIMACCHIA: 166,00**
con cordino piping
tortora / gambe laccate tortora
antracite / gambe laccate antracite

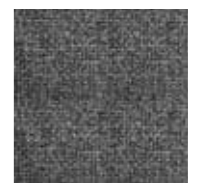
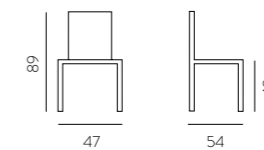

NIVES ANTRACITE
LACCATO ANTRACITE



NIVES TORTORA
LACCATO TORTORA



Art. 8150

■ IMBALLO N. 2 pz.

Imballo speciale 1 pz. + 10,00 netto

■ NORMALMENTE IN PRONTA CONSEGNA

■ GAMBЕ: ROVERE MASSELLO TINTO:
noce canaletto - rovere naturale - anilina nera

■ ECOPELLE LION: **311,00**
cuoio 305 - titanio 020

■ VELLUTO ANTIMACCHIA DAVIS: **311,00**
tortora chiaro 16 - antracite 95

■ BOUCLÈ ANTIMACCHIA DAVIS: **323,00**
antracite 92 - sabbia 05

■ STOFFA CLIENTE (1,5 MT.) TEMPI 40 gg. **426,00**

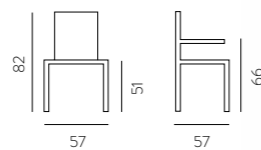

L'ecopelle nei colori chiari potrebbe macchiarsi a contatto con indumenti non trattati (es. jeans). Per la pulizia dei prodotti utilizzare solo acqua tiepida e un panno morbido in microfibra. Non usare solventi o prodotti aggressivi. Il velluto potrebbe presentare effetti che non sono da considerare difettosità in quanto caratteristiche della composizione e del tipo di lavorazione: effetto a macchia o marazzatura, effetto chiaro/scuro, effetto impronta

Sgabello Art. 8571 vedi pag. 266



Art. 8148

NORMALMENTE IN PRONTA CONSEGNA

GAMBE **ROVERE MASSELLO** TINTE:
noce canaletto - rovere - anilina nera

VELLUTO DAVIS **289,00**
grigio 91 - antracite 95
tortora chiaro 16 - brown 26
verde pistacchio 36 - senape 41 - mattone 51 - ottanio 76

ECOPELLE LION **289,00**
cuoio 305 - titanio 020

STOFFA CLIENTE (1,5 MT.) TEMPI 40 gg. **372,00**

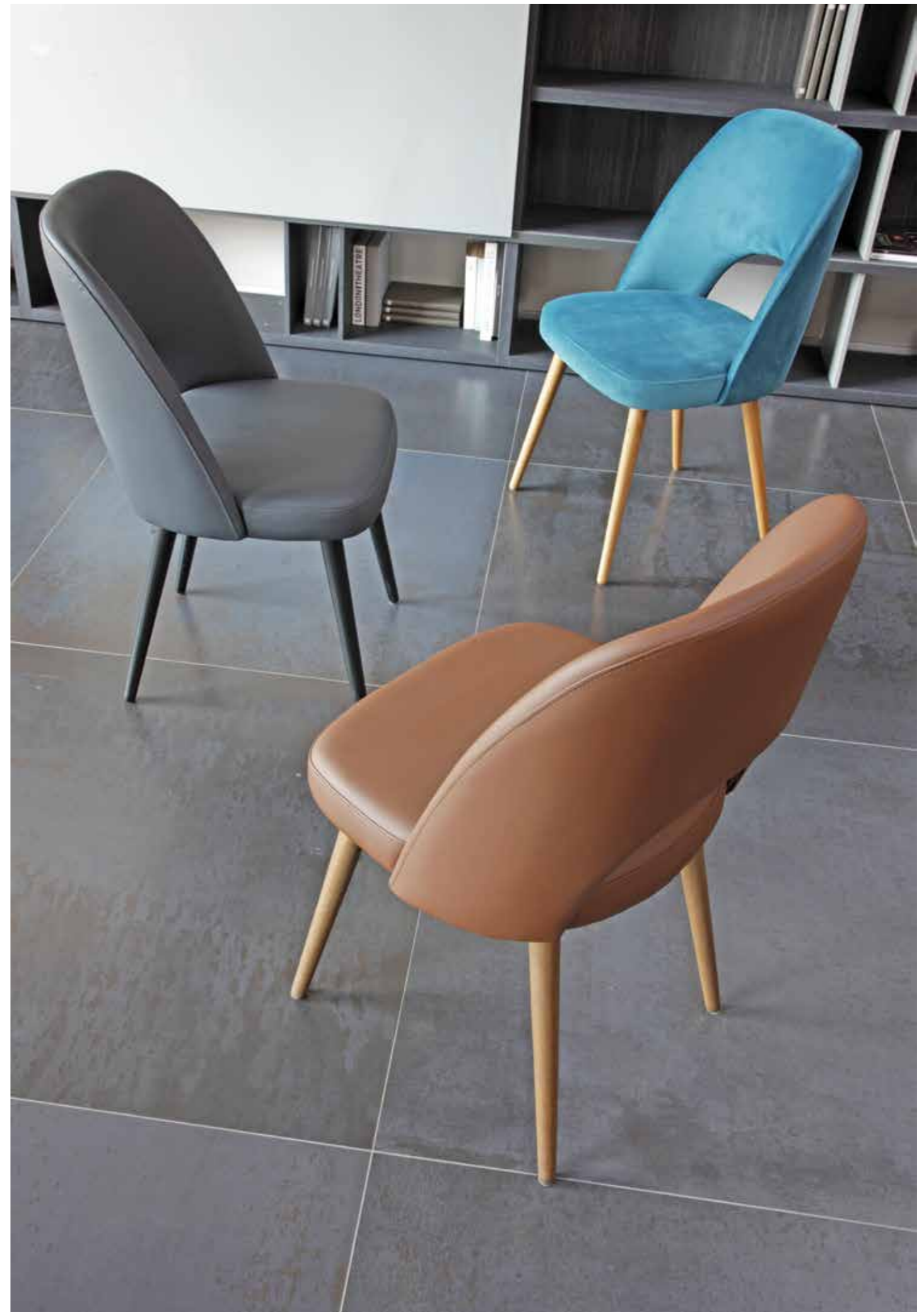
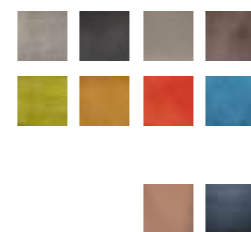
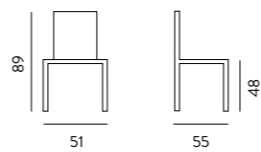



Art. 8154

- **IMBALLO N. 2 pz.**
Imballo speciale 1 pz. + 10,00 netto
- **NORMALMENTE IN PRONTA CONSEGNA**
- **GAMBE: ROVERE MASSELLO TINTO:**
noce canaletto - rovere naturale - anilina nera
- **ECOPELLE LION:** 300,00
cuoio 305 - titanio 020
- **VELLUTO ANTIMACCHIA DAVIS:** 300,00
tortora chiaro 16 - antracite 95

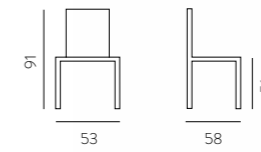

Sgabello
Art. 8571
pag. 266

L'ecopelle nei colori chiari potrebbe macchiarsi a contatto con indumenti non trattati (es. jeans). Per la pulizia dei prodotti utilizzare solo acqua tiepida e un panno morbido in microfibra. Non usare solventi o prodotti aggressivi. Il velluto potrebbe presentare effetti che non sono da considerare difettosità in quanto caratteristiche della composizione e del tipo di lavorazione: effetto a macchia o marazzatura, effetto chiaro/scuro, effetto impronta





La tinta delle gambe, essendo materiale naturale, può variare da partita a partita

Art. 8130

■ **IMBALLO N. 4 pz.**
Imballo speciale 1/3 pz. + 10,00 netto

■ **NORMALMENTE IN PRONTA CONSEGNA**

■ **GAMBE:** MASSELLO TINTO: naturale - noce americano
■ **SEDILE:** ECOPELLE: bianca - sabbia - titanio

231,00



bianco

sabbia

grigio titanio

L'ecopelle nei colori chiari potrebbe macchiarsi a contatto con indumenti non trattati (es. jeans).
Per la pulizia dei prodotti utilizzare solo acqua tiepida e un panno morbido in microfibra.
Non usare solventi o prodotti aggressivi.

■ **STOFFA CLIENTE (1,5 MT.) Tempi 40 gg:** 297,00

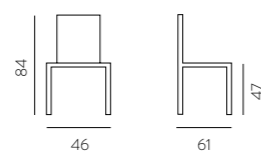



Art. 8250

- **IMBALLO N. 4 pz.**

Imballo speciale 1/3 pz. + 10,00 netto

- **NORMALMENTE IN PRONTA CONSEGNA**

- **GAMBE: MASSELLO TINTO: noce medio**

- **SEDILE ECOPELLE:
sabbia, bordino caffè**

289,00

- **STOFFA CLIENTE (1,5 MT.) Tempi 40 gg.**

389,00

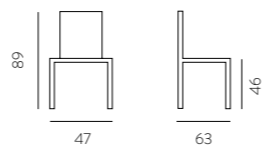

La tinta delle gambe, essendo materiale naturale, può variare da partita a partita
L'ecopelle nei colori chiari potrebbe macchiarsi a contatto con indumenti non trattati (es. jeans). Per la pulizia dei prodotti utilizzare solo acqua tiepida e un panno morbido in microfibra. Non usare solventi o prodotti aggressivi.



Art. 8129 sfoderabile

■ IMBALLO N. 2 pz.

Imballo speciale 1 pz. + 10,00 netto

■ NORMALMENTE IN PRONTA CONSEGNA

■ STRUTTURA LEGNO NOCE MEDIO - LACCATO NERO

■ TESSUTO ANTIMACCHIA IDROREPELLENTE: **177,00**
 antracite - tortora - senape - celeste

■ RIVESTIMENTO EXTRA / RICAMBIO TESSUTO **77,00**
 antracite - tortora - senape - celeste

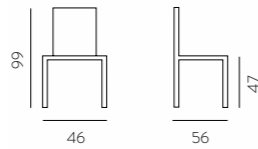

LAVAGGIO A SECCO MAX. 40°
 (no candeggio, non asciugare al sole)

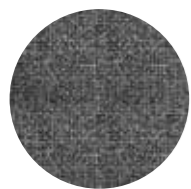

antracite

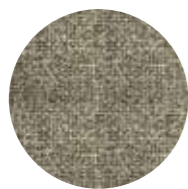

tortora



senape

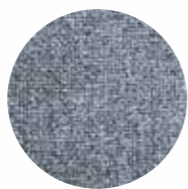

celeste



Art. 8116

- IMBALLO N. 2 pz.
Imballo speciale 1 pz. + 10,00 netto
- **NORMALMENTE IN PRONTA CONSEGNA**
- ECOPELLE grigio ghiaccio **143,00**
STRUTTURA laccata in tinta



Art. 8122

- IMBALLO N. 2 pz.
Imballo speciale 1 pz. + 10,00 netto
- **NORMALMENTE IN PRONTA CONSEGNA**

ECOPELLE: bianco - sabbia - titanio - grigio ghiaccio
STRUTTURA laccata in tinta

131,00 (con cover € 240,00)

ECOPELLE: testa di moro/STRUTTURA wengè

131,00 (con cover € 240,00)

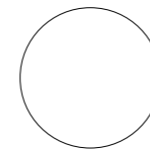

bianco



sabbia

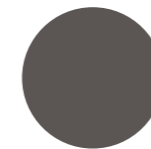

titanio

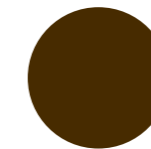

testa di moro



grigio ghiaccio



corredate di vitone tirafondi per ulteriore robustezza

L'ecopelle nei colori chiari potrebbe macchiarsi a contatto con indumenti non trattati (es. jeans).
Per la pulizia dei prodotti utilizzare solo acqua tiepida e un panno morbido in microfibra. Non usare solventi o prodotti aggressivi.



sabbia

bianco lino

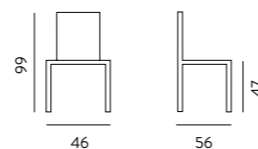

Art. 8126 cover

solo per Art. 8122 - 8116
COTONE QUALITY **109,00** solo cover



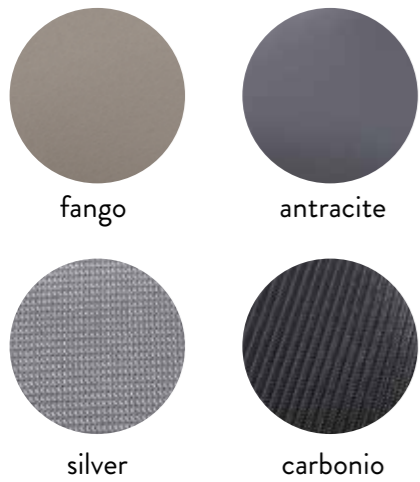

Sgabello 8565 - pag. 290



Art. 8062

■ IMBALLO: STRUTTURA N. 4 pz. - SEDILI N. 2 pz.
Imballo speciale 1/3 pz. + 10,00 netto

■ **NORMALMENTE IN PRONTA CONSEGNA**

■ STRUTTURA: ALLUMINIO - ANTRACITE
■ SEDILI:

ECOPELLE: FANGO - ANTRACITE

ECOPELLE HIGH TECH: SILVER - CARBONIO

133,00

142,00

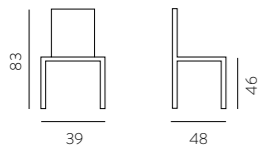

Art. 8095

■ IMBALLO N. 2 pz.
Imballo speciale 1 pz. + 10,00 netto

■ **NORMALMENTE IN PRONTA CONSEGNA**

■ STRUTTURA LACCATA: bianca - sabbia - titanio / SEDILI ECOPELLE IN TINTA

■ STRUTTURA LACCATA: nera / SEDILI TESSUTO DARK GREY

■ STRUTTURA LEGNO TINTA: noce / SEDILI CUIOIO

155,00

155,00

155,00

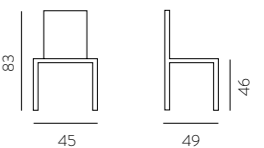



Art. 8288

- **IMBALLO N. 2 pz.**
Imballo speciale 1 pz. + 10,00 netto
 - **NORMALMENTE IN PRONTA CONSEGNA**
 - **GAMBE:**
MASSELLO DI FAGGIO: tinto naturale
 - **SEDILE: PATCH multicolor**
- 234,00**

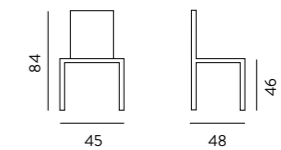

Art. 8022

- **IMBALLO N. 2 pz.**
Imballo speciale 1 pz. + 10,00 netto
- **NORMALMENTE IN PRONTA CONSEGNA**
- **GAMBE:**
MASSELLO DI FAGGIO: tinto naturale
- **SEDILE:**
POLIPROPILENE: bianco - grigio quarzo - nero

144,00

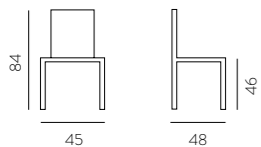

Sgabello 8522 - pag. 281

Art. 8291

- **IMBALLO N. 4 pz.**
Imballo speciale 1/3 pz. + 10,00 netto
- **NORMALMENTE IN PRONTA CONSEGNA**
- **GAMBE:**
MASSELLO DI FAGGIO: tinto naturale
- **SEDILE: PATCH multicolor**

333,00

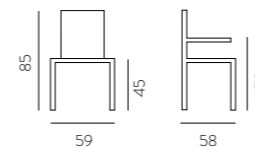



Art. 8026

- **IMBALLO N. 2 pz.**
Imballo speciale 1 pz. + 10,00 netto
- **NORMALMENTE IN PRONTA CONSEGNA**
- **CUSCINO COTONE ANTRACITE**
- **GAMBE:**
MASSELLO DI FAGGIO: tinto naturale
- **SEDILE:**
POLIPROPILENE: bianco

287,00

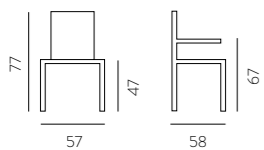

Art. 8290

- **IMBALLO N. 2 pz.**
Imballo speciale 1 pz. + 10,00 netto
- **NORMALMENTE IN PRONTA CONSEGNA**
- **GAMBE: MASSELLO DI FAGGIO: tinto naturale**
- **SEDILE: POLIPROPILENE: bianco - nero**

212,00

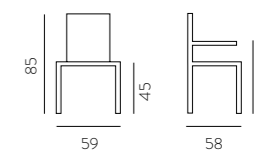

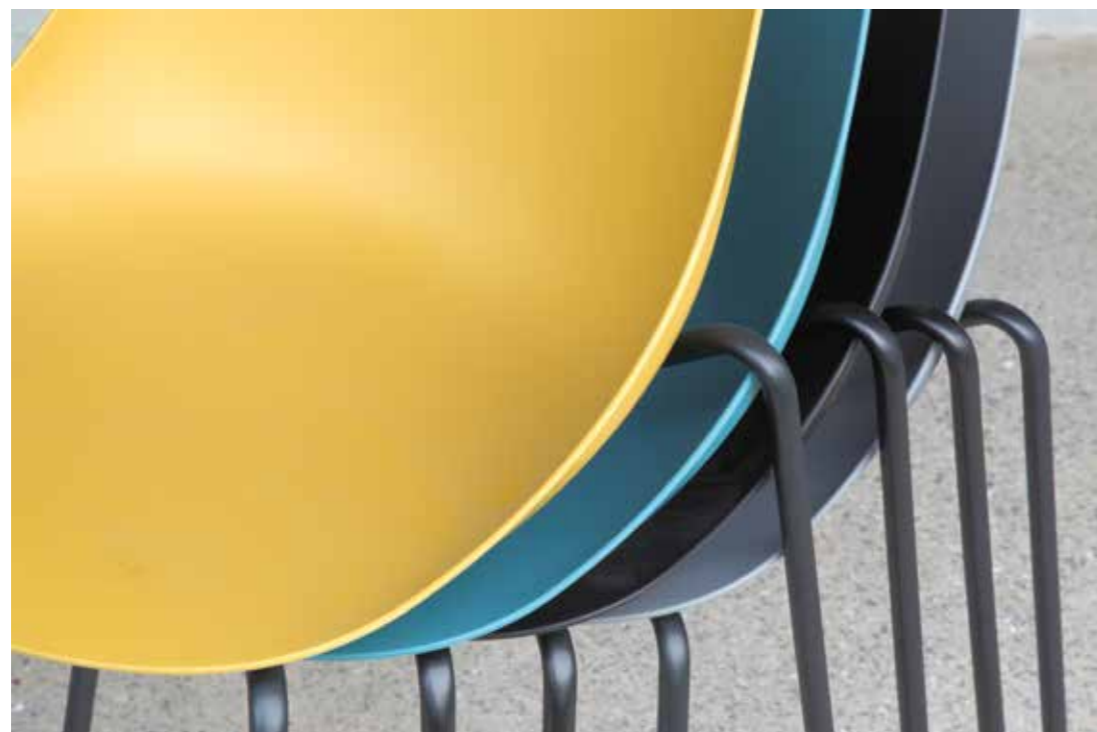

Art. 803

- **IMBALLO N. 4 pz.**
Imballo speciale 1/3 pz. + 10,00 netto
- **NORMALMENTE IN PRONTA CONSEGNA**
- **STRUTTURA NERA**
- **SEDILI POLIPROPILENE:**
grigio - nero - senape - ottanio **133,00**

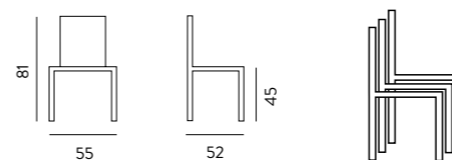



Art. 8019

■ **IMBALLO N. 4 pz.**
Imballo speciale 1/3 pz. + 10,00 netto

■ **NORMALMENTE IN PRONTA CONSEGNA**

■ **STRUTTURA: CROMATA**

■ **SEDILI**
POLIPROPILENE:
bianco - grigio quarzo

133,00

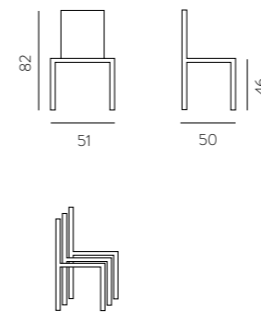



Sgabello 8527 vedi pag. 289

Art. 8027

■ **IMBALLO N. 4 pz.**
Imballo speciale 1/3 pz. + 10,00 netto

■ **NORMALMENTE IN PRONTA CONSEGNA**

- POLIPROPILENE BIANCO PANNA/METALLO BIANCO PANNA 156,00
- POLIPROPILENE TORTORA/METALLO BIANCO PANNA 156,00
- POLIPROPILENE ANTRACITE/METALLO ANTRACITE 156,00

SUO SGABELLO ART. 8527 VEDI PAG. 289



bianco panna

tortora

antracite

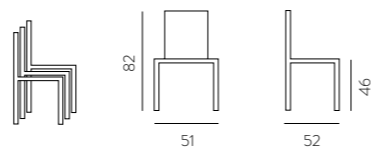

Gli eventuali segni di stampaggio sono fisiologici, dovuti all'utilizzo del Fiberglass per dare struttura e solidità al prodotto.

Art. 8064

■ **IMBALLO N. 4 pz.**
Imballo speciale 1/3 pz. + 10,00 netto

■ **NORMALMENTE IN PRONTA CONSEGNA**

■ **STRUTTURA METALLO VERNICIATA NERA**

- **SEDILI POLIPROPILENE:** 108,00
nero - tortora fango - orange - ottanio - verde
- SUO SGABELLO ART. 8564/... VEDI PAG. 288

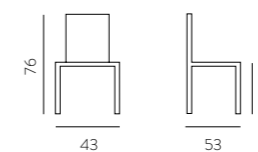

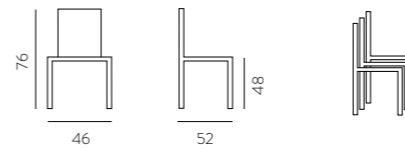

Art. 8075

■ **IMBALLO N. 4 pz.**
Imballo speciale 1/3 pz. + 10,00 netto

■ **NORMALMENTE IN PRONTA CONSEGNA**

- POLIPROPILENE BIANCO - ANTRACITE / TESSUTO ANTIMACCHIA GRIGIO 152,00
- POLIPROPILENE TORTORA / TESSUTO ANTIMACCHIA TORTORA 152,00

Gli eventuali segni di stampaggio sono fisiologici, dovuti all'utilizzo del Fiberglass per dare struttura e solidità al prodotto.





Art. 809

- IMBALLO N. 4 pz.
Imballo speciale 1/3 pz. + 10,00 netto

■ **NORMALMENTE IN PRONTA CONSEGNA**

■ POLIPROPILENE:

COLOR STRUTTURA NERA / sedile e schienale: OTTANIO - VERDE - MATTONE - GIALLO
TUTTA: BIANCA - ANTRACITE --- BICOLORE SABBIA / BIANCA

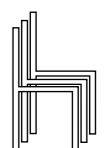
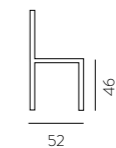
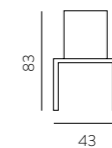

Impilabile 2 pz.

121,00
121,00





Art. 8028

- **IMBALLO N. 2 pz.**
Imballo speciale 1 pz. + 10,00 netto
 - **NORMALMENTE IN PRONTA CONSEGNA**
 - **STRUTTURA:** **POLICARBONATO**
- | | |
|--------------------|---------------|
| trasparente | 201,00 |
| fumè | 211,00 |

PRODOTTI IN POLICARBONATO
Data la particolare tecnologia di questo articolo il prodotto potrebbe presentare dei segni superficiali, queste particolarità non riducono le caratteristiche di estetica e resistenza del prodotto.

Avvertenze e manutenzione:
pulire con panno morbido, non abrasivo, imbevuto di sola acqua
Non usare:
solventi, sgrassanti, alcool etilico e detersivi
(perchè tendono a cristallizzare, facendo perdere le capacità di flessibilità e alta resistenza al prodotto)

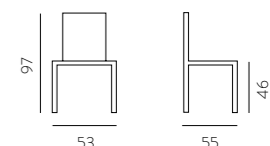



Art. 8029

- **IMBALLO N. 4 pz.**
Imballo speciale 1/3 pz. + 10,00 netto
- **NORMALMENTE IN PRONTA CONSEGNA**
- **STRUTTURA:** POLICARBONATO
- **SEDILI trasparente** 200,00

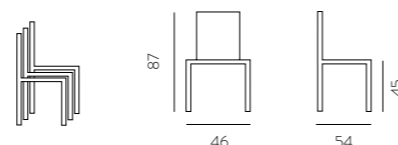

Art. 8037/1

- **IMBALLO N. 4 pz.**
Imballo speciale 1/3 pz. + 10,00 netto
- **NORMALMENTE IN PRONTA CONSEGNA**
- **STRUTTURA:** POLICARBONATO
trasparente 199,00
trasparente fumè 199,00

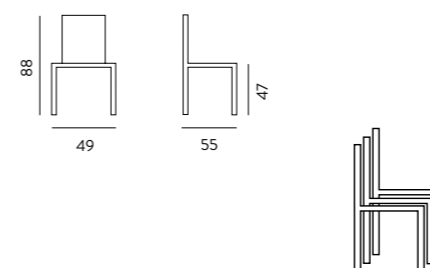

Art. 8037/2

- **IMBALLO N. 2 pz.**
Imballo speciale 1 pz. + 10,00 netto
- **NORMALMENTE IN PRONTA CONSEGNA**
- **STRUTTURA:** POLICARBONATO
trasparente 222,00
trasparente fumè 222,00

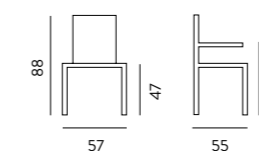

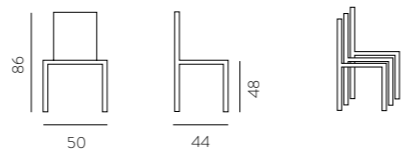

Art. 8033/1

- **IMBALLO N. 4 pz.**
Imballo speciale 1/3 pz. + 10,00 netto
- **NORMALMENTE IN PRONTA CONSEGNA**
- **STRUTTURA: POLICARBONATO**
- trasparente 178,00
- trasparente fumè 188,00



PRODOTTI IN POLICARBONATO
Data la particolare tecnologia di questo articolo il prodotto potrebbe presentare dei segni superficiali, queste particolarità non riducono le caratteristiche di estetica e resistenza del prodotto.

Avvertenze e manutenzione:
pulire con panno morbido, non abrasivo, imbevuto di sola acqua
Non usare:
solventi, sgrassanti, alcool etilico e detersivi
(perchè tendono a cristallizzare, facendo perdere le capacità di flessibilità e alta resistenza al prodotto)

SGABELLI POLICARBONATO
pag. 286

Art. 8033/2

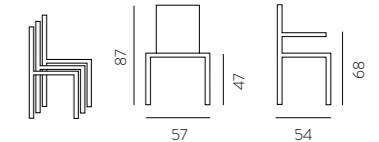

- **IMBALLO N. 4 pz.**
Imballo speciale 1/3 pz. + 10,00 netto
- **NORMALMENTE IN PRONTA CONSEGNA**
- **STRUTTURA: POLICARBONATO**
- trasparente - trasparente fumè 222,00

Art. 8033/1 trasparente fumè

Art. 8033/6

- **IMBALLO N. 4 pz.**
Imballo speciale 1/3 pz. + 10,00 netto
- **NORMALMENTE IN PRONTA CONSEGNA**
- **STRUTTURA: POLICARBONATO**
- trasparente 156,00

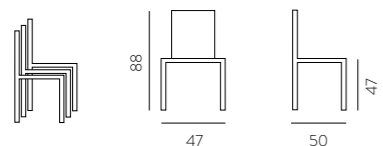



Art. 807

- **IMBALLO N. 4 pz.**
Imballo speciale 1/3 pz. + 10,00 netto
- **NORMALMENTE IN PRONTA CONSEGNA**
- **STRUTTURA POLIPROPILENE BIANCO**
POLICARBONATO: trasparente **152,00**

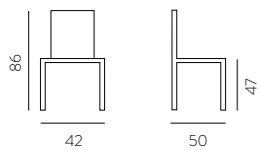

Art. 8048

- **IMBALLO N. 4 pz.**
Imballo speciale 1/3 pz. + 10,00 netto
- **PER CONTRACT PILE INDUSTRIALI N. 22 pz. MONOCOLORE**
- **NORMALMENTE IN PRONTA CONSEGNA**
- **POLIPROPILENE:**
bianco - grigio avio - nero - tortora **109,00**

INDOOR | OUTDOOR



PER GROSSE FORNITURE
CHIEDERE QUOTAZIONE

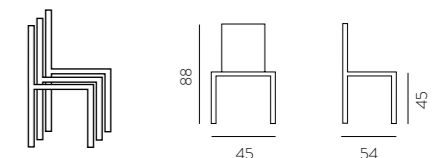



Art. 8014

- IMBALLO N. 4 pz.
Imballo speciale 1/3 pz. /
imballo 4 pz. colori misti + 10,00 netto
- PER CONTRACT PILE INDUSTRIALI N. 25 pz. MONOCOLORE
- **NORMALMENTE IN PRONTA CONSEGNA**
- POLIPROPILENE: 97,00
grigia - tortora - nero - bianco
mattone - senape - verde bosco - avio

PER GROSSE FORNITURE
CHIEDERE QUOTAZIONE

INDOOR | OUTDOOR

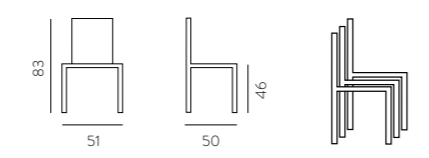



Art. 8012

- **IMBALLO N. 4 pz.**
Imballo speciale 1/3 pz. + 10,00 netto
- **PER CONTRACT PILE INDUSTRIALI N. 23 pz. MONOCOLORE**

■ **NORMALMENTE IN PRONTA CONSEGNA**

■ **STRUTTURA POLIPROPILENE: bianco - tortora - nero**

97,00

INDOOR | OUTDOOR

PER GROSSE FORNITURE
CHIEDERE QUOTAZIONE

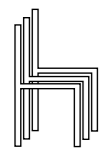
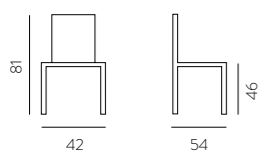

Art. 8045

INDOOR | OUTDOOR

- **IMBALLO N. 4 pz.**
Imballo speciale 1/3 pz. + 10,00 netto
- **PER CONTRACT PILE INDUSTRIALI N. 22 pz. MONOCOLORE**

■ **NORMALMENTE IN PRONTA CONSEGNA**

■ **POLIPROPILENE OPACO: bianco - tortora chiaro**

132,00

PER GROSSE FORNITURE
CHIEDERE QUOTAZIONE

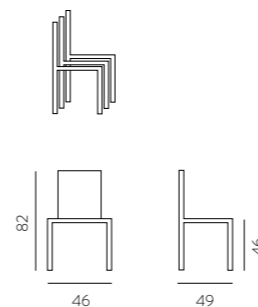



Sedia Art. 8021

- **IMBALLO N. 4 pz.**
Imballo speciale 1/3 pz. + 10,00 netto
- PER CONTRACT PILE INDUSTRIALI N. 25 pz. MONOCOLORE

■ **NORMALMENTE IN PRONTA CONSEGNA**

- **POLIPROPILENE:** 88,00
bianco - nero - sabbia soft
marsala - zafferano - verde oliva - ottanio

L 51 | P 57 | HS 46 | HT 79

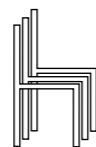

Sgabello Art. 8520/7 NB HSedile 78

- **IMBALLO N. 4 pz.** Imballo speciale 1/3 pz. + 10,00 netto
- **NORMALMENTE IN PRONTA CONSEGNA**
- **POLIPROPILENE:** bianco - nero - sabbia 108,00



INDOOR | OUTDOOR

PER GROSSE FORNITURE
CHIEDERE QUOTAZIONE



Art. 8040

- **IMBALLO N. 4 pz.**
Imballo speciale 1/3 pz. + 10,00 netto
- **NORMALMENTE IN PRONTA CONSEGNA**

- **POLIPROPILENE:** 132,00
bianco - grigio - nero - tortora
ottanio - senape - verde

NB: Gli eventuali segni di stampaggio sono fisiologici, dovuti all'utilizzo del Fiberglass per dare struttura e solidità al prodotto

INDOOR | OUTDOOR

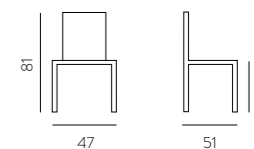



con braccioli Art. 8051/BR
 ■ stessi colori sedia 153,00
 ■ IMBALLO N. 6 pz. TAX per colore
 ■ TEMPI 30 GG.

INDOOR | OUTDOOR



SGABELLI pag. 284



Sedia Art. 8051

■ IMBALLO N. 4 pz.
 Imballo speciale 1/3 pz. + 10,00 netto

■ **NORMALMENTE IN PRONTA CONSEGNA**

■ **POLIPROPILENE:**
 antracite - tortora - grigio chiaro - bianco - senape - verde oliva - ottanio - cipria

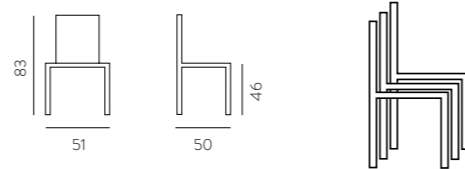

141,00





INDOOR | OUTDOOR



Sedia Art. 8050

- **IMBALLO N. 4 pz.**
Imballo speciale 1/3 pz. + 10,00 netto
- PER CONTRACT PILE INDUSTRIALI N. 24 pz. MONOCOLORE
- **NORMALMENTE IN PRONTA CONSEGNA**
- **STRUTTURA:**
RESINA RINFORZATA CON FIBERGLASS
COLORI:
sabbia - bianco - tortora - antracite - rosso - celeste - verde oliva

122,00

Sgabello Art. 8542

- 8542/6 H 65
- 8542/7 H 76

Vedi pag. 285

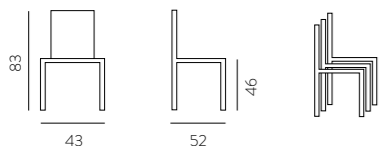

bianco
sabbia
tortora
antracite





Art. 8013

PER GROSSE FORNITURE
CHIEDERE QUOTAZIONE

- IMBALLO N. 4 pz.
Imballo speciale 1/3 pz. + 10,00 netto
- PER CONTRACT PILE INDUSTRIALI N. 25 pz. MONOCOLORE
- **NORMALMENTE IN PRONTA CONSEGNA**
- STRUTTURA POLIPROPILENE:
bianco - tortora - nero **108,00**

INDOOR | OUTDOOR

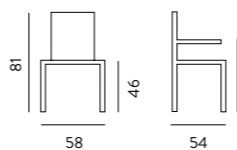

Art. 8055

- IMBALLO N. 4 pz.
Imballo speciale 1/3 pz. + 10,00 netto
- PER CONTRACT PILE INDUSTRIALI N. 24 pz. MONOCOLORE
- **NORMALMENTE IN PRONTA CONSEGNA**
- RESINA RINFORZATA CON FIBERGLASS: **132,00**
bianco - celeste - tortora - antracite - verde oliva
sabbia eliminato

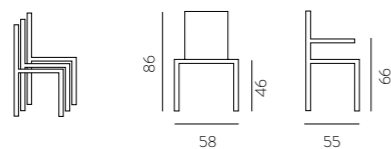

NB: nel colore antracite sono presenti i leggeri segni dello stampaggio

Art. 808

- IMBALLO N. 4 pz.
Imballo speciale 1/3 pz. + 10,00 netto
- **NORMALMENTE IN PRONTA CONSEGNA**
- POLIPROPILENE: bianco - sabbia - antracite **141,00**

INDOOR | OUTDOOR

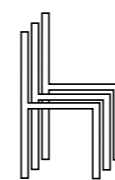
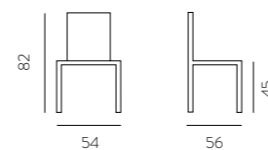

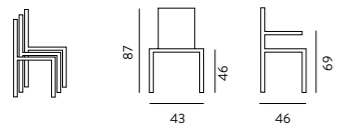

sedia appendibile,
pratica e comoda per le pulizie

Art. 8056

■ IMBALLO N. 4 pz.
Imballo speciale 1/3 pz. + 10,00 netto

■ **NORMALMENTE IN PRONTA CONSEGNA**

■ STRUTTURA POLIPROPILENE:

bianco-tortora-nero-senape-verde-ottanio **143,00**

NB: sui colori scuri sono presenti i segni dello stampaggio
il colore nero per uso outdoor va tenuto in zone ombreggiate



INDOOR | OUTDOOR





fino a 10 pz.

INDOOR | OUTDOOR

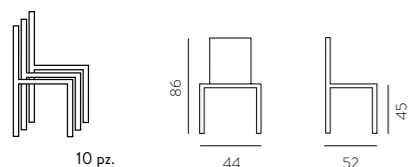

Sgabello
Art. 8528

POLIPROPILENE:
BIANCO - SABBIA - ANTRACITE
154,00

IMBALLO N. 4 pz.
Imballo speciale 1/3 pz. + 10,00 netto

Art. 8057

- IMBALLO N. 4 pz.
Imballo speciale 1/3 pz. + 10,00 netto
- PER CONTRACT PILE INDUSTRIALI N. 14 pz. MONOCOLORE
- **NORMALMENTE IN PRONTA CONSEGNA**

■ POLIPROPILENE: BIANCO - SABBIA - ANTRACITE

109,00



Art. 8078

- IMBALLO N. 4 pz.
Imballo speciale 1/3 pz. + 10,00 netto
- PER CONTRACT PILE INDUSTRIALI N. 14 pz. MONOCOLORE

■ **NORMALMENTE IN PRONTA CONSEGNA**

- RESINA RINFORZATA CON FIBERGLASS:
bianco - sabbia - nero 111,00

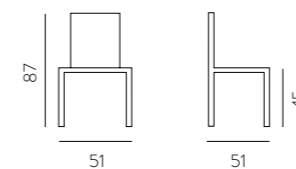

INDOOR | OUTDOOR





Art. 8084

- **IMBALLO N. 2 pz.**
Imballo speciale 1 pz. + 10,00 netto
- PER CONTRACT PILE INDUSTRIALI N. 10 pz. MONOCOLORE
- **NORMALMENTE IN PRONTA CONSEGNA**

- **STRUTTURA FAGGIO EUROPEO**
- TINTO NATURALE / CANNA INTRECCIATA 189,00
- TINTO NOCE (croce legno) / ECOPELLE BROWN 189,00
- TINTO NOCE (croce metallo) / ECOPELLE NERA 189,00

- **STRUTTURA FRASSINO**
- ANILINA NERA / ECOPELLE NERO 189,00

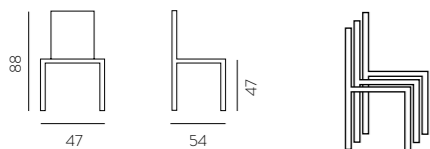

Art. 8080

- **IMBALLO N. 2 pz.**
Imballo speciale 1 pz. + 10,00 netto
- **NORMALMENTE IN PRONTA CONSEGNA**

- **STRUTTURA FAGGIO TINTO NOCE**
- **SEDUTA E SCHIENALE MASSELLO / MULTISTRATO** 177,00

OPZIONE
Per quantità superiore ai 30 pz. possibilità di customizzazione

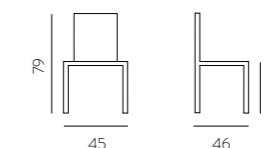



Sgabello Art. 8590 vedi pag. 292



Art. 8069

■ **IMBALLO N. 4 pz.**
Imballo speciale 1/3 pz. + 10,00 netto

■ **NORMALMENTE IN PRONTA CONSEGNA**

■ STRUTTURA METALLO:

- NATURALE PROTETTO DA VERNICE TRASPARENTE **121,00**
- BRUNITO **121,00**
- NERO OPACO **121,00**
- COUNTRY CHIC (BIANCO ANTICATO) **130,00**

PER GROSSE FORNITURE
CHIEDERE QUOTAZIONE

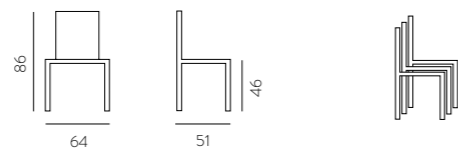

Art. 8085

PER GROSSE FORNITURE
CHIEDERE QUOTAZIONE

- **IMBALLO N. 4 pz.**
Imballo speciale 1/3 pz. + 10,00 netto
- PER CONTRACT PILE INDUSTRIALI N. 17 pz. MONOCOLORE
- **NORMALMENTE IN PRONTA CONSEGNA**

■ **GAMBE METALLO VERNICIATE NERE**

- **SEDILE RATTAN POLIPROPILENICO** **109,00**
nero - naturale

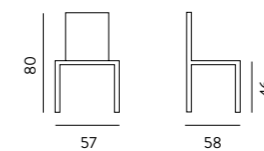

INDOOR | OUTDOOR



Sgabello
Art. 8585/...
pag. 291



Art. 8214

■ **IMBALLO N. 2 pz.**
Imballo speciale 1 pz. + 10,00 netto

■ **NORMALMENTE IN PRONTA CONSEGNA**

■ **GAMBE**
METALLO VERNICIATO nero

■ **SEDILE ECOPELLE**
cuoio vissuto cognac

244,00



Sgabello - pag. 282

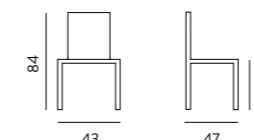
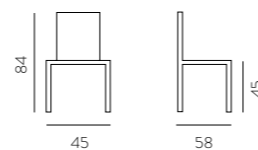

Sgabello Art. 8563
vedi pag. 291

Art. 8063

■ **IMBALLO N. 5 pz.**
Imballo speciale 1/4 pz. + 10,00 netto

■ **NORMALMENTE IN PRONTA CONSEGNA**

■ **STRUTTURA METALLO VERNICIATA NERA (TUBO Ø 25 MM)**

- **LAMINATO NERO** PLACCATO SU MULTISTRATI **109,00**

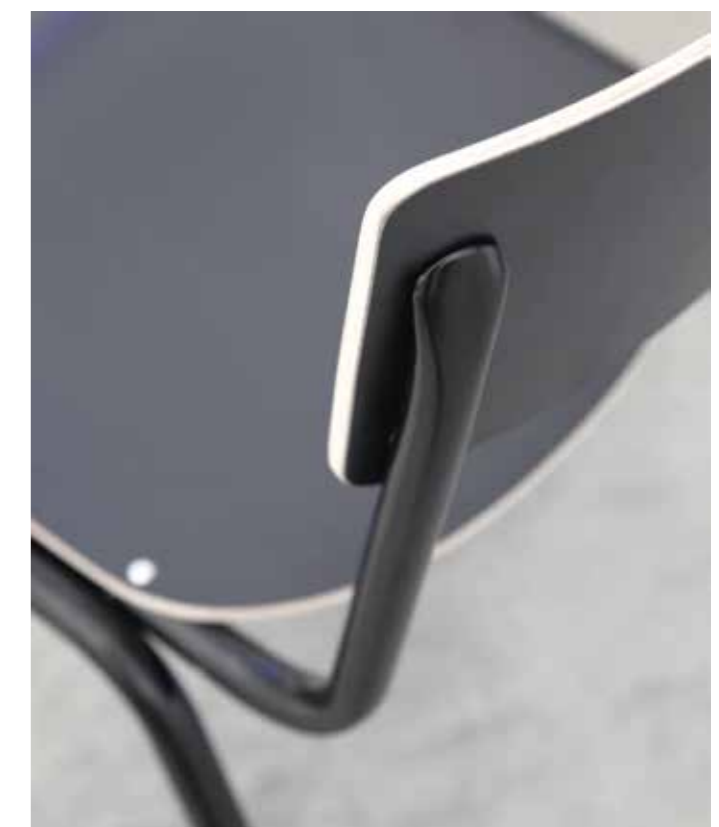



Art. 81031 **Piramide** 144,00
40x40-H72 verniciata nera
per piani max 90x90



Art. 81032 **Piatta** 144,00
40x40-H72 verniciata nera
per piani max 90x90



Art. 81032 **Piatta White** 144,00
40x40-H72 verniciata bianca
per piani max 90x90



Art. 81043 **Bistrot**
43x43-H73 183,00
- verniciata nera
- per piani max 90x90
- foratura non adatta per piani Art. 81049
(usare n. 8 viti autofilettanti)



Art. 81041 **Bistrot Snack**
43x43-H108 209,00
- verniciata nera
- per piani max 80x80
- foratura non adatta per piani Art. 81049
(usare n. 8 viti autofilettanti)



Art. 81052 **Impero**
43x43-H73 183,00
- verniciata nera
- per piani max 90x90

- foratura non adatta per piani Art. 81049
(usare n. 8 viti autofilettanti)

piani clienti, schema di foratura G02 (piastra 300 x 300 mm)
per basi: 81031 - 81032 - 81034 - 81037 - 81038 - 81046 LS **Como**

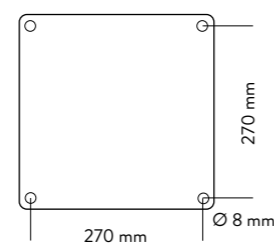

pedini regolabili



Art. 81037/D **Kuadra Double**
(2 colonne 8x8) 75x40-H72 per piani max 140x90
verniciata nera 291,00
inox lucido 302,00
inox satinato 325,00

BASI & PIANI CONTRACT NORMALMENTE IN PRONTA CONSEGNA

Indoor & Outdoor uso dehor coperto
non adatte per ambienti estremamente umidi,
per zone saline, spiagge, ecc.
vedi basi Troll e Rimini



Art. 81034 **Piatta Snack** 178,00

40x40-H108
verniciata: **nera - bianca**
per piani max 70x70
dotate di pedini regolabili



inox lucido H72 166,00
Art. 81037 **Kuadra Inox**
acciaio satinato H72 166,00
Art. 81037 **Kuadra Satinè**
base 40x40-tubo 8x8
per piani max 90x90



acciaio satinato H108 178,00
Art. 81037 HG **Kuadra High**
base 40x40-tubo 8x8
per piani max 80x80



ottone galvanico satinato Piatta Gold
base 40x40-tubo 8x8
H72 Art. 81024 188,00
per piani max 90x90
H108 Art. 81025 198,00
per piani max 70x70

TAGLIO A MISURA IN ALTEZZA + € 45,00 netti



Base Como verniciata nera
 Ø45-H73 Art. 81046. **LS45 156,00**
 per piani max Ø80 - 70x70
 Ø54-H73 Art. 81046. **LS54 188,00**
 per piani max Ø100 - 80x80
 Ø60-H73 Art. 81046. **LS60 302,00**
 per piani max Ø130

Art. 81035 **Big Round**
 verniciata nera **381,00**
 per piani max Ø180

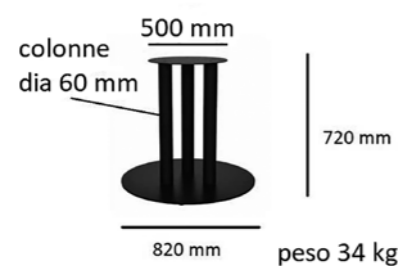

piani clienti,
 schema di foratura G02

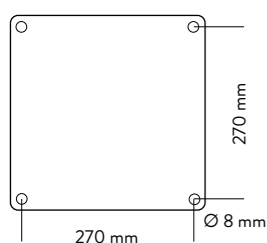

**NORMALMENTE
 IN PRONTA
 CONSEGNA**

ACCESSORIO
anello ottone H 10 cm
 per **Base Como:**
 satinato + € 20,00
 lucido + € 27,00

per **Base Quadra:**
 satinato + € 26,00
 lucido + € 32,00



Base Art. 81046 **LSH Como Snack 177,00**

H108 Ø45 con piedini nera
 adatta anche per **OUTDOOR**
 per piani max 70x70
 dotate di piedini regolabili

Piedino regolabile



Basi Tonde Torino

acciaio **satinato**
H73 Art. 81036/1 **154,00**
H108 Art. 81036/2 **176,00**

ottone galvanico **satinato**
H73 Art. 81026 **200,00**

Base Ø45 - Tubo 76 mm
 per piani max Ø80 - 70x70

Piedino regolabile



Art. 81808
 70x70 **312,00**
 80x80 **322,00**

Bancale da 20 pz. € 40,00 netti
 Bancale speciale 1/9 pz. € 30,00 netti
 Bancale speciale 10/19 pz. € 30,00 netti

Tavolo completo per outdoor
accatastabile / autolivellante

Tavolo metallo 4 gambe saldate
 con trattamento per esterno
 Verniciato:
bianco - antracite - nero



RICHIEDI PROGRAMMA COMPLETO CONTRACT OUTDOOR VIA MAIL

BASE mod. RIMINI ALLUMINIO
PER ZONE SALINE O ALTO TASSO DI UMIDITÀ

Base in acciaio verniciato (zavorra),
 con cover alluminio
 Tubo 8x8 in alluminio verniciato

H 72 Art. 81760 **156,00**
 40x40-H72 verniciata nera
 per piani max 90x90

H 108 Art. 81762 **189,00**
 40x40-H72 verniciata nera
 per piani max 70x70

Piedino regolabile

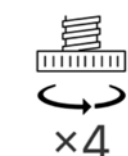

Piani Art. 81049 nobilitato **espressi** USO INDOOR

 spessore 25 mm

misure e colori tassativamente fissi (no costo gestione) CONSEGNA SU BANCALE REGGIATO

foratura bussole solo per basi: Art. 81031 - 81032 - 81034 - 81037 - 81038 - 81046.LS45/54/60
 Per altre basi: applicazione bussole antistrappo (con vite brugola) + € 8,00 netti

NORMALMENTE IN PRONTA CONSEGNA

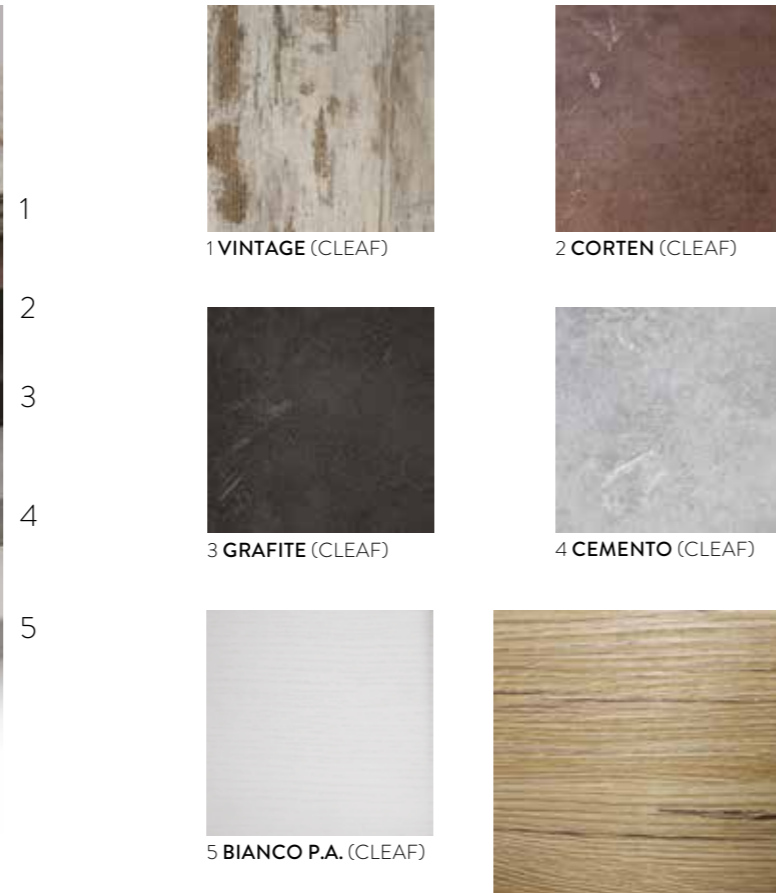

I nostri piani hanno incluse bussole antistrappo con viti 6MA 

NOBILITATO / BORDO ABS:

dimensione **67x67** (bar/ristorante piccolo) **109,00**

dimensione **80x80** (misura classica ristorante) **142,00**

Art. 81050 **GPR GANCI PER PROLUNGA** per basamento centrale

18,00 cad. Gancio per prolunghe, con gancio si intende maschio / femmina (set 4 ganci per singola prolunga **72,00**)

solo per piani 25 mm Art. 81049 da aggiungere costo (non applicabili su piani 50 mm, e stratificati)

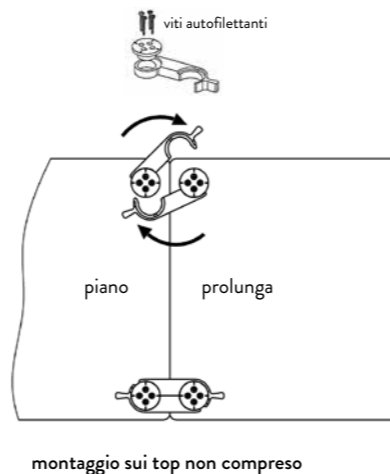
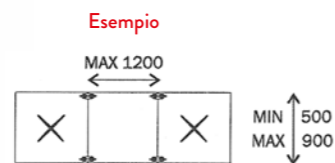

Piani Art. 81051 **HPL stratificato espressi** INDOOR / OUTDOOR

 spessore 10 mm, bordo dritto, con attacco universale

misure e colori tassativamente fissi (no costo gestione) CONSEGNA SU BANCALE REGGIATO

Sistema di fissaggio universale
 Possibilità di applicazione a tutte le basi

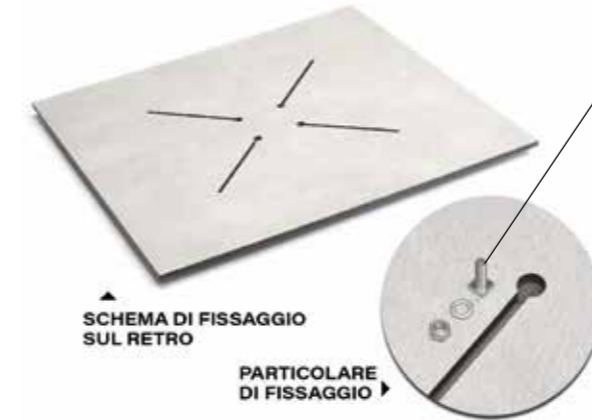

VITERIA SPECIALE INCLUSA

NORMALMENTE IN PRONTA CONSEGNA
 NO COSTO GESTIONE

DALLE MISURE INDICATE MANCA 1 CM PER LATO

IMPORTANTE:
I COLORI SCURI
VANNO TENUTI IN ZONE OMBREGGiate
 (L'ASSORBIMENTO DEI RAGGI UVA ACCUMULA CALORE E TENDONO A STORTARSI)



rovere nodato MAH
 70x70 **189,00***
 80x80 **211,00***



corten CRT
 70x70 **189,00***
 80x80 **211,00***



marmo nero THT
 70x70 **189,00***
 80x80 **211,00***

* supplemento gestione ordini (preparazione ordine, costo bancale e imballo - ferramenta speciale inclusa):
 1/9 pz. € 40,00 netti totali - 10/19 pz. € 30,00 netti totali - oltre 20 pz. incluso



cimento CMT
 70x70 **189,00***
 80x80 **211,00***



marmo bianco BLI
 70x70 **189,00***
 80x80 **211,00***



bianco BNC (corpo nero)
 70x70 **175,00***
 80x80 **200,00***



Basi TROLL

ALLUMINIO

(con zavorra e piedini regolabili)
verniciata NERO

MECCANISMO
CHIUSURA
TOP QUALITY



fissa h73 Art. 81740/1 142,00
fissa h109 Art. 81740/2 156,00
consigliabile anche per uso indoor

chiudibile bassa h73 Art. 81750/1 165,00
chiudibile alta h108 Art. 81750/2 178,00

NORMALMENTE IN PRONTA CONSEGNA

NB: aggiungere piano, vedi HPL
vedi pag. prima



Piedino regolabile



adatte per zone marine
spiagge, ecc.



BASI e PIANI per OUTDOOR



Art. 81100TE Piano Teak

NORMALMENTE IN PRONTA CONSEGNA

Teak massello (vero teak indonesiano)

70 x 70 199,00

80 x 80 219,00

Ø 70 189,00

Optional applicazione bussola antistrappo (con vite brugola)

+ € 8,00 netti consigliabile solo per basi in ghisa

..... RICHIEDI PROGRAMMA COMPLETO **CONTRACT OUTDOOR** VIA MAIL

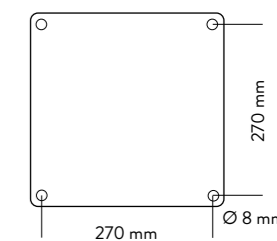

piani TECNOWOOD

Listelli resina effetto wood, tinta teak - spessore 18 mm

NB: NO MANUTENZIONE fine stagione

Sotto struttura metallo con trattamento elettrolitico antiruggine,
verniciata polvere doppio passaggio

TOP 70x70 Art. 81204 197,00

TOP 80x80 Art. 81204 222,00

predisposto per basi con piastre G02 (interasse 270 mm.)





Art. 8550

- IMBALLO N. 1 pz.
- **NORMALMENTE IN PRONTA CONSEGNA**
- CUSCINETTO ECOPELLE IN TINTA
- STRUTTURA: CROMATO
- SEDILI
POLIPROPILENE: bianco-arancio-rosso-verde-nero-grigio chiaro
143,00
- RICAMBI: guarnizione sottobase (tipo piccolo) 21,00 - pistone 40,00
- **USO DOMESTICO, NON GARANTITO PER LOCALE PUBBLICO**

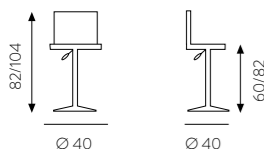

Art. 8584

- IMBALLO N. 2 pz.
Imballo speciale 1 pz. + 10,00 netto
- **NORMALMENTE IN PRONTA CONSEGNA**
- STRUTTURA NERA
- SEDILI
POLIPROPILENE NERO / ECOPELLE nero **152,00**
- POLIPROPILENE NERO / VELLUTO CUSTOM:
ottanio - verde - giallo - mattone - grigio fumo - tortora **152,00**
- RICAMBI: guarnizione sottobase (tipo grande) 21,00 - pistone 40,00
- **USO DOMESTICO, NON GARANTITO PER LOCALE PUBBLICO**

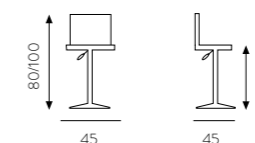

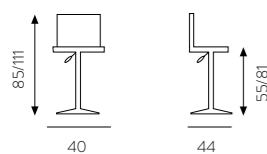

Pompa High Quality



Base design acciaio pieno

Art. 8575

- IMBALLO N. 1 pz.
- **NORMALMENTE IN PRONTA CONSEGNA**
- STRUTTURA:
- **SEDILE SCHIUMATO**
ECOPELLE: **bianco - nero - titanio**
ECOPELLE SPECIAL / STOFFA CLIENTE 1 MT. (TEMPI 30 GG)

CROMATO

421,00
547,00

Ecopelle di serie



Ecopelle special



L'ecopelle nei colori chiari potrebbe macchiarsi a contatto con indumenti non trattati (es. jeans).
Per la pulizia dei prodotti utilizzare solo acqua tiepida e un panno morbido in microfibra.
Non usare solventi o prodotti aggressivi.



Art. 8574

- IMBALLO N. 1 pz.
- **NORMALMENTE IN PRONTA CONSEGNA**
- STRUTTURA: CROMATO
- **SEDILI**
ECOPELLE: **bianco-nero-tortora chiaro**
199,00
STOFFA CLIENTE 1 MT. tempi 40 gg. **277,00**
- RICAMBI:
guarnizione sottobase (tipo piccolo) **21,00**
pistone **40,00**
- **USO DOMESTICO, NON GARANTITO PER LOCALE PUBBLICO**

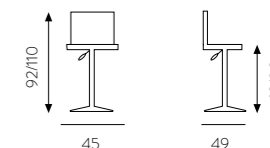

Art. 8571/6 H65

- IMBALLO N. 1 pz.
- **NORMALMENTE IN PRONTA CONSEGNA**
- STRUTTURA: ROVERE MASSELLO
noce canaletto - rovere natuirale - anilina nera

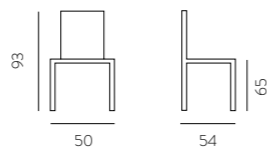

- ECOPELLE LION: cuoio 305 - titanio 020 **379,00**
- VELLUTO ANTIMACCHIA DAVIS: tortora chiaro 16 - antracite 95 **379,00**

ECOPELLE LION

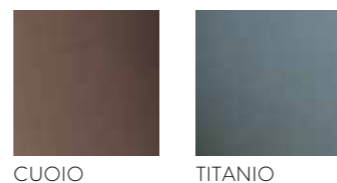

Art. 8571/7 H75

- IMBALLO N. 1 pz.
- **NORMALMENTE IN PRONTA CONSEGNA**
- STRUTTURA: ROVERE MASSELLO
noce canaletto - rovere natuirale - anilina nera

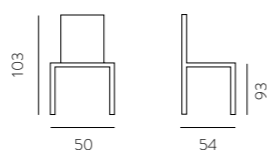

- ECOPELLE LION: cuoio 305 - titanio 020 **389,00**
- VELLUTO ANTIMACCHIA DAVIS: tortora chiaro 16 - antracite 95 **389,00**

VELLUTO ANTIMACCHIA DAVIS

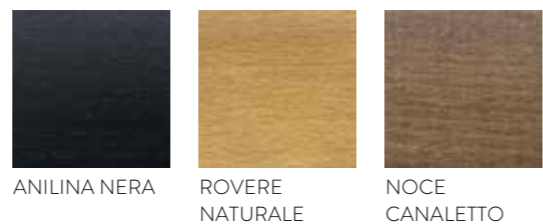
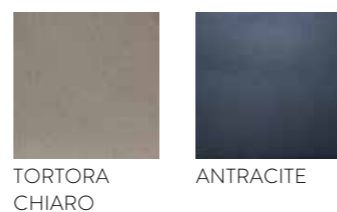

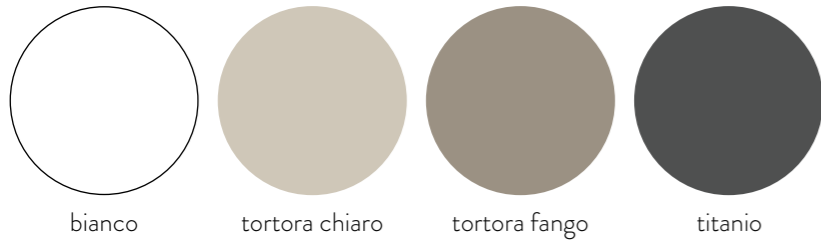

Art. 8538

■ **IMBALLO N. 2 pz.**
Imballo speciale 1 pz. + 10,00 netto

■ **NORMALMENTE IN PRONTA CONSEGNA**

■ **STRUTTURA: METALLO RIVESTITO / ACCIAIO SATINATO**

■ **ECOPELLE:**
bianco - tortora chiaro - tortora fango - grigio titanio **311,00**

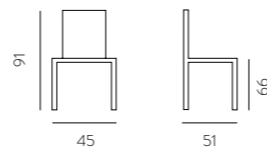

L'ecopelle nei colori chiari potrebbe macchiarsi a contatto con indumenti non trattati (es. jeans).
Per la pulizia dei prodotti utilizzare solo acqua tiepida e un panno morbido in microfibra. Non usare solventi o prodotti aggressivi.



Art. 8509/6

■ **IMBALLO N. 4 pz.**
Imballo speciale 1/3 pz. + 10,00 netto

■ **NORMALMENTE IN PRONTA CONSEGNA**

■ **STRUTTURA: METALLO VERNICIATA NERA**

■ **TESSUTO ANTIMACCHIA:** **219,00**
tortora - antracite

■ **STOFFA CLIENTE (1,5 MT.)** **278,00**

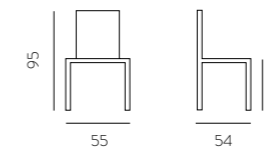

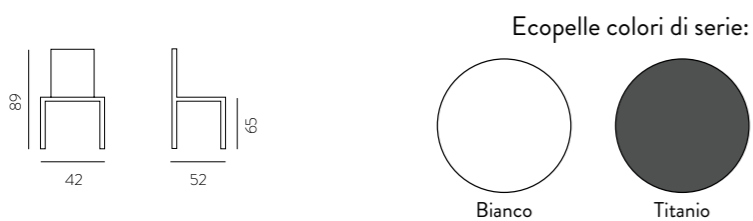

Art. 8561/6

■ **IMBALLO N. 2 pz.**
Imballo speciale 1 pz. +10,00 netto

■ **NORMALMENTE IN PRONTA CONSEGNA**

■ **STRUTTURA:** CROMATO

■ **SEDILE SCHIUMATO**

ECOPELLE: **bianco-titanio** 356,00

ECOPELLE SPECIAL (TEMPI 30 GG) 457,00

STOFFA CLIENTE 1 MT (TEMPI 30 GG) 435,00



Ecopelle colori speciali:

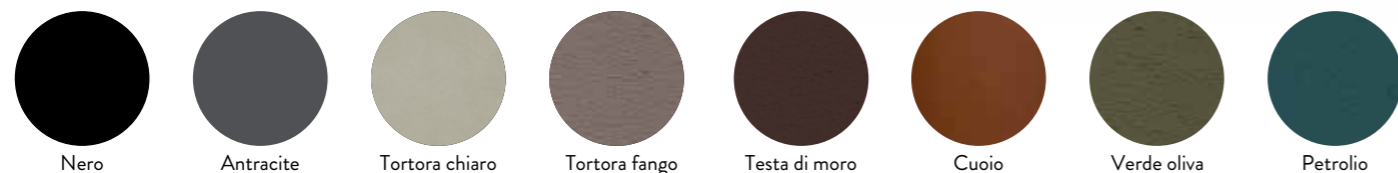

Art. 8557/6

■ **IMBALLO N. 4 pz.**
Imballo speciale 1/3 pz. +10,00 netto

■ **NORMALMENTE IN PRONTA CONSEGNA**

■ **STRUTTURA:** CROMATO NERA TITANIO

■ SEDILI	CROMATO	NERA	TITANIO
ECOPELLE: bianco	290,00	-	-
ECOPELLE: nero	290,00	-	-
ECOPELLE: titanio	-	-	290,00
ECOPELLE SPECIAL (TEMPI 30 GG)	380,00	380,00	380,00
STOFFA CLIENTE 1 MT (TEMPI 30 GG)	368,00	368,00	368,00

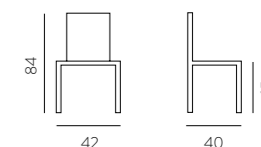



■ ART. 8568/6 H65 300,00

■ ART. 8568/7 H75 311,00

■ STRUTTURA METALLO VERNICIATA NERO
CON PUNTALI OTTONE GALVANICO

■ VELLUTO: sabbia - grigio fumo

■ NORMALMENTE IN PRONTA CONSEGNA

VERSIONE CUSTOM - 40 GG

H65

■ STOFFA CLIENTE (1,5 MT) 390,00

H75

■ STOFFA CLIENTE (1,5 MT) 401,00



sabbia



grigio fumo



Il velluto potrebbe presentare effetti che non sono da considerare difettosità in quanto caratteristiche della composizione e del tipo di lavorazione: effetto a macchia o marazzatura, effetto chiaro/scuro, effetto impronta

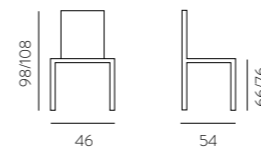

ACCESSORIO
anello ottone H 10 cm
per Base Como:
satinato + € 20,00
lucido + € 27,00

per Base Quadra:
satinato + € 26,00
lucido + € 32,00





- **VELLUTO ANTIMACCHIA:**
nero - antracite - grigio perla - rosa cipria - verde bosco
tortora - ottanio - mattone



- **GAMBE VERNICIATE NERE** Ø 22 conifata

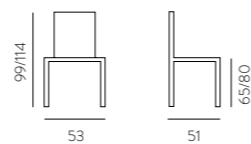

- **NORMALMENTE IN PRONTA CONSEGNA**
- **IMBALLO N. 4 pz.** - Imballo speciale 1/3 pz. + 10,00 netto

■ ART. 8506/6 H65	219,00	STOFFA CLIENTE (1,5 MT)	278,00
■ ART. 8506/8 H80	233,00	STOFFA CLIENTE (1,5 MT)	291,00

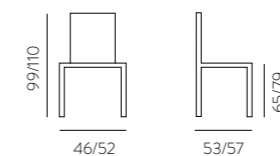

accessorio
pedino ottone

Art. **8517/6**

- **IMBALLO N. 1 pz.**

SGABELLO H 65

- **NORMALMENTE IN PRONTA CONSEGNA**
- **NERO/VELLUTO*** **300,00**

accessorio pedino ottone H 8 cm + € 40,00 set 4 pz.

- **OTTONE/VELLUTO*** **399,00**
ottone lucido a bagno galvanico "MADE IN ITALY"

*VELLUTO:
grigio fumo - tortora - senape - arancio - blu - verde

SGABELLO H 80 Art. 8517/8

- **NERO/VELLUTO*** **324,00**
- **STOFFA CLIENTE (1 MT) TEMPI 40 GG.** **+ 88,00**





Art. 8566/6

- IMBALLO N. 1 pz.
- **NORMALMENTE IN PRONTA CONSEGNA**
- STRUTTURA: METALLO VERNICIATA NERA
- TESSUTO ANTIMACCHIA: 354,00
tortora - salvia - mandarino - antracite

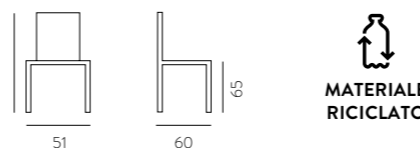

- ART. 8582/6 H65 354,00
- ART. 8582/8 H80 365,00

- IMBALLO N. 1 pz.
- **NORMALMENTE IN PRONTA CONSEGNA**

- STRUTTURA METALLO VERNICIATA NERO LAMBORGHINI
- VELLUTO ANTIMACCHIA:
grigio fumo - celeste - rosa - verde - ottanio - mattone - giallo

- STOFFA CLIENTE (1,5 MT) TEMPI 40 GG. + 117,00

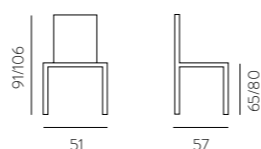

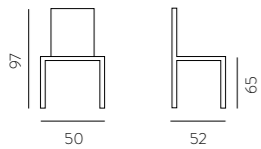

■ **IMBALLO N. 4 pz.**
Imballo speciale 1/3 pz. + 10,00 netto

■ **NORMALMENTE IN PRONTA CONSEGNA**

■ **STRUTTURA METALLO VERNICIATA nero**

■ **SEDILE RETRO SCHIENALE LISCIO**

ECOPELLE EFFETTO NABUK:
beige - grigio

ECOPELLE UNICOLOR:
ghiaccio - fango - titanio - nera

■ **ART. 8510/1 BASE SLITTA H65** 279,00

■ **ART. 8510/2 BASE 4 GAMBE H65** 309,00

■ **ART. 8510/3 BASE 4 GAMBE H80** 324,00

■ **STOFFA CLIENTE (1,2MT) TEMPI 40 GG.** + 95,00

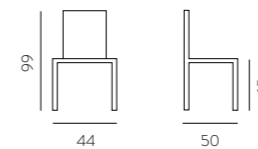

Art. **8518**

■ **IMBALLO N. 2 pz.**
Imballo speciale 1 pz. + 10,00 netto

■ **NORMALMENTE IN PRONTA CONSEGNA**

■ **METALLO VERNICIATO IN TINTA
POGGIAPIEDI ACCIAIO NATURALE**

■ **ECOPELLE: sabbia - titanio** 289,00





Art. 8579

- **IMBALLO N. 2 pz.**
Imballo speciale 1 pz. + 10,00 netto
- **NORMALMENTE IN PRONTA CONSEGNA**
- **STRUTTURA:**
METALLO RIVESTITO, GAMBE VERNICIATE IN TINTA



- **SEDILI**
SIMILCUOIO PVC:
bianco - sabbia - titanio

290,00

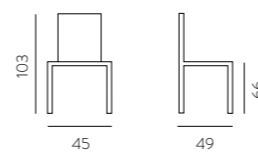
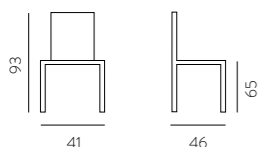

Art. 8522

- **IMBALLO N. 4 pz.**
Imballo speciale 1/3 pz. + 10,00 netto
- **NORMALMENTE IN PRONTA CONSEGNA**
- **GAMBE: MASSELLO DI FAGGIO: tinto naturale**
- **SEDILE POLIPROPILENE:**
bianco - grigio quarzo - nero

186,00





■ **IMBALLO N. 4 pz.**
 Imballo speciale 1/3 pz. + 10,00 netto

■ **NORMALMENTE IN PRONTA CONSEGNA**

■ **STRUTTURA METALLO VERNICIATA nero**

■ **SEDILE:**
 ECOPELLE cuoio vissuto

■ **ART. 8514/1**
 BASE SLITTA H65 279,00

■ **ART. 8514/2**
 BASE 4 GAMBE H65 309,00

■ **ART. 8514/3**
 BASE 4 GAMBE H80 324,00

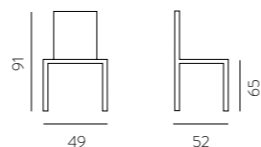

■ **IMBALLO N. 4 pz.**
 Imballo speciale 1/3 pz. + 10,00 netto

■ **NORMALMENTE IN PRONTA CONSEGNA**

■ **STRUTTURA METALLO VERNICIATA nero**
 ■ **ECOPELLE EFFETTO NABUK: beige - grigio**

■ **ART. 8500/1** BASE SLITTA H65 279,00

■ **ART. 8500/2** BASE 4 GAMBE H65 309,00

■ **ART. 8500/3** BASE 4 GAMBE H80 324,00

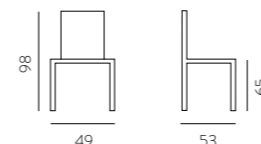

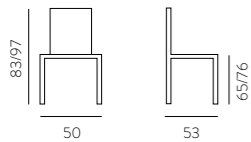

■ **IMBALLO N. 4 pz.**
Imballo speciale 1/3 pz. + 10,00 netto

INDOOR | OUTDOOR

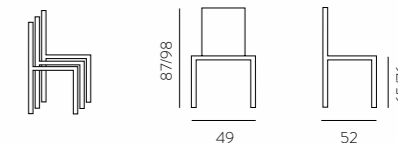

■ **NORMALMENTE IN PRONTA CONSEGNA**

■ **STRUTTURA**

RESINA RINFORZATA: **bianco** **sabbia** **tortora** **antracite** **celeste** **verde oliva**

■ Art. **8542/6** H 65 152,00 152,00 152,00 152,00 152,00 152,00

■ Art. **8542/7** H 76 160,00 - 160,00 160,00 160,00 160,00



■ **POLIPROPILENE:**
antracite - verde oliva - ottanio - senape
bianco - grigio chiaro - tortora - fango

NB: colori non compatibili con sedia Art. 8014

■ **ART. 8549/6** H 65 166,00
■ **NORMALMENTE IN PRONTA CONSEGNA**

■ **IMBALLO N. 4 pz.**
Imballo speciale 1/3 pz. / imballo 4 pz. colori misti + 10,00 netto

INDOOR | OUTDOOR

■ **ART. 8549/7** H 76 174,00
■ **TEMPI 25/30 GG**



bianco
sabbia
tortora
antracite



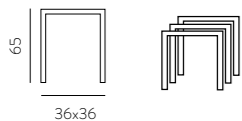

Art. 8540

- **IMBALLO N. 2 pz.**
Imballo speciale 1 pz. + 10,00 netto
- **NORMALMENTE IN PRONTA CONSEGNA**
- **STRUTTURA POLICARBONATO TRASPARENTE**

187,00

PRODOTTI IN POLICARBONATO
Data la particolare tecnologia di questo articolo il prodotto potrebbe presentare dei segni superficiali, queste particolarità non riducono le caratteristiche di estetica e resistenza del prodotto.

- **IMBALLO N. 2 pz.**
Imballo speciale 1 pz. + 10,00 netto
- **NORMALMENTE IN PRONTA CONSEGNA**
- **STRUTTURA POLICARBONATO TRASPARENTE**

- **Art. 8544/6 H 65** 301,00
- **Art. 8544/7 H 74** 306,00



Avvertenze e manutenzione:
pulire con panno morbido, non abrasivo, imbevuto di sola acqua
Non usare:
solventi, sgrassanti, alcool etilico e detersivi
(perchè tendono a cristallizzare, facendo perdere le capacità di flessibilità e alta resistenza al prodotto)

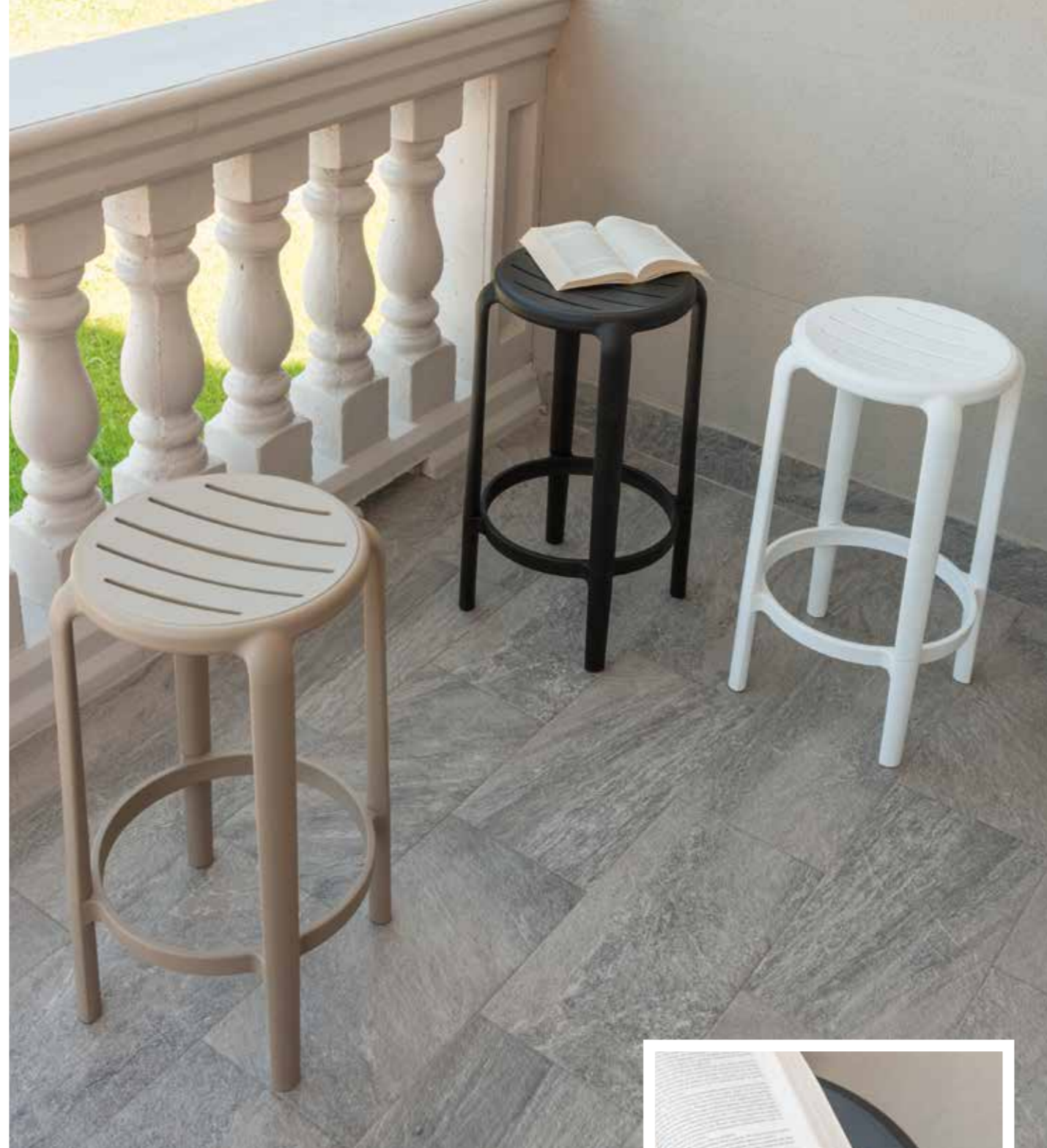

INDOOR | OUTDOOR

- **ART. 8526/6 H65** 128,00
- **ART. 8526/7 H75** 132,00

■ **POLIPROPILENE RINFORZATO CON FIBERGLASS:**
bianco - nero - sabbia

■ **NORMALMENTE IN PRONTA CONSEGNA**

■ **IMBALLO N. 4 pz.**
Imballo speciale 1/3 pz. + 10,00 netto

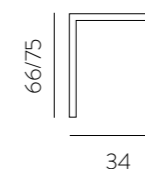



- **IMBALLO N. 4 pz.**
Imballo speciale 1/3 pz. + 10,00 netto
- **NORMALMENTE IN PRONTA CONSEGNA**
- **STRUTTURA METALLO VERNICIATA nero**
- **SEDUTA POLIPROPILENE:**
nero - tortora fango - orange - ottanio - verde

- **ART. 8564/6 H65** **178,00**
- **ART. 8564/7 H75** **189,00**

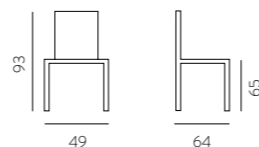

- 
bianco panna
- 
tortora
- 
antracite

Art. 8527

- **IMBALLO N. 2 pz.**
Imballo speciale 1 pz. + 10,00 netto
- **NORMALMENTE IN PRONTA CONSEGNA**

- POLIPROPILENE **BIANCO PANNA**/METALLO BIANCO PANNA **222,00**
- POLIPROPILENE **TORTORA**/METALLO BIANCO PANNA **222,00**
- POLIPROPILENE **ANTRACITE**/METALLO ANTRACITE **222,00**

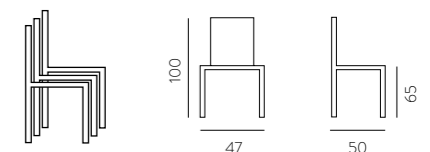

Art. 8565

- IMBALLO: STRUTTURA N. 1 pz. - SEDILI N. 2 pz.
Imballo speciale sedile 1 pz. + 5,00 netto
- **NORMALMENTE IN PRONTA CONSEGNA**
- STRUTTURA: ALLUMINIO - ANTRACITE
- SEDILI:
- ECOPELLE: FANGO - ANTRACITE
- ECOPELLE HIGH TECH: SILVER - CARBONIO

189,00

198,00

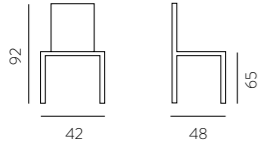

fango



antracite

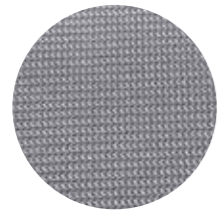

silver



carbonio



Art. 8563

- IMBALLO N. 2 pz. - Imballo speciale 1 pz. + 10,00 netto
- **NORMALMENTE IN PRONTA CONSEGNA**
- STRUTTURA METALLO VERNICIATA NERA (TUBO Ø 25 MM)
- LAMINATO NERO PLACCATO SU MULTISTRATI

199,00



Sgabello impilabile etnico

- STRUTTURA METALLO VERNICIATA NERA
- INTRECCIO RATTAN POLIPROPILENICO: nero - naturale
- IMBALLO N. 4 pz. - Imballo speciale 1/3 pz. + 10,00 netto
- **NORMALMENTE IN PRONTA CONSEGNA**
- H 65 Art. 8585/6 171,00 INDOOR | OUTDOOR
- H 75 Art. 8585/7 178,00



Art. 8507

- IMBALLO N. 2 pz.
- Imballo speciale 1 pz. + 10,00 netto
- **NORMALMENTE IN PRONTA CONSEGNA**
- GAMBE MASSELLO DI FAGGIO tinto naturale
- SEDILE POLIPROPILENE bianco

99,00

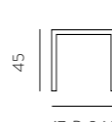

- STRUTTURA FAGGIO NATURALE
- PARTICOLARI POLIPROPILENE nero
- IMBALLO N. 1 pz.
- **NORMALMENTE IN PRONTA CONSEGNA**
- Art. 8508/4 DA H 42 A 55 177,00
- Art. 8508/6 DA H 67 A 80 212,00



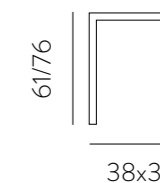

Art. 8580 200,00

- IMBALLO N. 1 pz.
- **NORMALMENTE IN PRONTA CONSEGNA**
- STRUTTURA METALLO VERNICIATA NERO INDUSTRIAL
- SEDILE LEGNO NOCE INDUSTRIAL

- STRUTTURA METALLO VERNICIATA NERA
- SEDILE ECOPELLE nera
- SEDILE VELLUTO ANTIMACCHIA:
- beige - rosa - grigio fumo - tortora - ottanio - verde - mattone
- IMBALLO N. 1 pz.
- **NORMALMENTE IN PRONTA CONSEGNA**
- H 67 Art. 8532/6 177,00
- H 77 Art. 8532/7 184,00

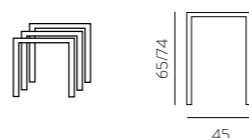

- IMBALLO N. 4 pz.
- Imballo speciale 1/3 pz. + 10,00 netto
- **NORMALMENTE IN PRONTA CONSEGNA**

- Art. 8590/6 H 65:
- COUNTRY CHIC (BIANCO ANTICATO) 110,00
- BRUNITO 110,00
- NATURALE PROTETTO DA VERNICE TRASPARENTE 110,00
- NERO OPACO 110,00

- Art. 8590/7 H 74:
- COUNTRY CHIC (BIANCO ANTICATO) 119,00
- BRUNITO 119,00
- NATURALE PROTETTO DA VERNICE TRASPARENTE 119,00
- NERO OPACO 119,00



Art. 8462

■ **IMBALLO N. 4 pz.**
Imballo speciale 1/3 pz. + 10,00 netto

■ **NORMALMENTE IN PRONTA CONSEGNA**

■ **STRUTTURA** METALLO
■ **SEDILI** POLIPROPILENE: bianco - nero - brown 96,00

Art. 8481/CA Carrello 167,00
(max 8 pz.) 38x50xh119
Art. 8481/G Gancio 76,00
(max 6 pz.) L 40 - P 21

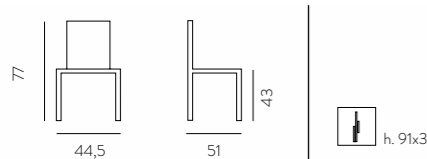

Art. 8463

■ **IMBALLO N. 4 pz.**
Imballo speciale 1/3 pz. + 10,00 netto

■ **NORMALMENTE IN PRONTA CONSEGNA**

■ **STRUTTURA METALLO CROMO**
■ **SEDILI POLIPROPILENE TRASLUCIDO** 107,00

Art. 8481/CA Carrello 167,00
(max 8 pz.) 38x50xh119
Art. 8481/G Gancio 76,00
(max 6 pz.) L 40 - P 21

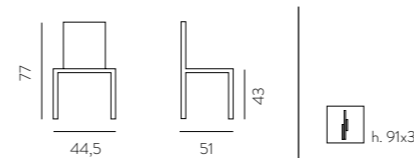



Art. 8468

- IMBALLO N. 4 pz.
Imballo speciale 1/3 pz. + 10,00 netto
- **NORMALMENTE IN PRONTA CONSEGNA**
- **POLIPROPILENE:**
bianco - antracite* - sabbia - verde **122,00**

* i leggeri segni sono dovuti alla stampa su colore scuro

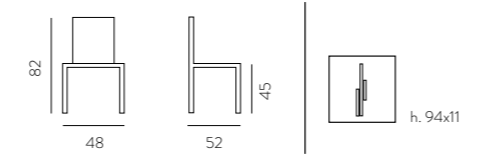

INDOOR | OUTDOOR
DESIGN E ROBUSTEZZA
ADATTA ANCHE PER OUTDOOR



Gancio a muro Art. 8481/G
(max 6 pezzi)
L.40 - P. 21
76,00



Carrello Art. 8481/CA
(max 8 pezzi)
38x50xh.119
167,00



Art. 8465

- IMBALLO N. 6 pz.
Imballo speciale 1/5 pz. + 10,00 netto
- **NORMALMENTE IN PRONTA CONSEGNA**
- **STRUTTURA METALLO ALLUMINIO / SEDILI POLIPROPILENE: NERO - BIANCO TRASLUCIDO **83,00****
- **STRUTTURA METALLO TORTORA / SEDILI POLIPROPILENE TORTORA CHIARO **83,00****
- **STRUTTURA METALLO NERA / SEDILI POLIPROPILENE NERO **83,00****

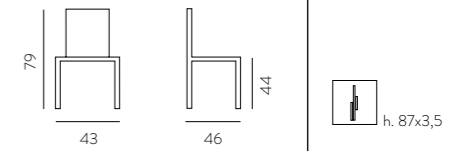



Versione **tortora**

piani realizzati con tecnologia folding
(evita la giunta della fascia col piano, antiestetica)

Sedia Art. 8465 vedi pag. 297

Tavolino trasformabile Art. 8757

■ **NORMALMENTE IN PRONTA CONSEGNA**

■ **MISURE:** 120 x 80 aperto 153/186/220 - H minima 25/ H 75 H fascia 12

- NOBILITATO **tortora** / STRUTTURA **tortora** 1.646,00
- NOBILITATO **bianco poro aperto** / STRUTTURA **bianca** pag. dopo 1.646,00
- NOBILITATO **cemento vissuto** / STRUTTURA **alluminio** pag. dopo 1.674,00
- NOBILITATO **vintage** / STRUTTURA **tortora** 2 pag. dopo 1.674,00
- NOBILITATO **rovere nodato** / STRUTTURA **tortora** 2 pag. dopo 1.674,00
- NOBILITATO **MATERICO ardesia** / STRUTTURA **antracite** 3 pag. dopo 1.674,00





Versione **bianco poro aperto** - H fascia 12 cm

Piani realizzati con tecnologia folding
(evita la giunta della fascia col piano, antiestetica)



Versione **cemento vissuto**

piani realizzati con tecnologia folding
(evita la giunta della fascia col piano, antiestetica)

Tavolino trasformabile Art. **8757**

Misure e prezzi
vedi pag. prima





Versione **rovere nodato**



Versione **vintage**

piani realizzati con tecnologia folding
(evita la giunta della fascia col piano, antiestetica)

Tavolino trasformabile

Art. **8757**

Misure e prezzi vedi 2 pag. prima





Versione **ardesia**



Tavolino trasformabile

Art. **8757**

Misure e prezzi vedi 3 pag. prima

piani realizzati con tecnologia folding
(evita la giunta della fascia col piano, antiestetica)

basalto grey



antracite



rovere naturale



cemento

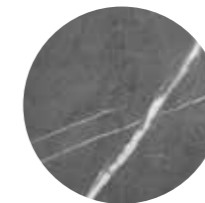

pietra grey

Tavolino trasformabile

Art. **8758**

■ **NORMALMENTE IN PRONTA CONSEGNA**

■ MISURE: 110 x 70 aperto 110 x 140 - H minima 25/ H 75

Pompa a gas HIGH QUALITY

■ **SOLO BASE** SOMMARE PIANO O PIANO CLIENTE (SET CERNIERE 28,00)

antracite 717,00
alluminio* 694,00
bianca* 694,00
cromata* 778,00

* **VEDI PAG. DOPO**

■ **SOLO PIANI** SOMMARE ALLA BASE:

■ NOBILITATO rovere naturale 470,00
■ NOBILITATO rovere nodato 470,00
■ NOBILITATO cemento* 470,00
■ NOBILITATO antracite 470,00
■ NOBILITATO basalto grey 470,00

■ **SOLO PIANI** SOMMARE ALLA BASE:

■ NOBILITATO bianco unito* 426,00
■ NOBILITATO bianco poro aperto* 426,00
■ NOBILITATO wengè* 426,00
■ NOBILITATO vintage* 470,00
■ NOBILITATO pietra grey 470,00



Versione **cemento** (base alluminio)

Sedia Art. 8465 vedi pag. 297

Versione **cemento** (base cromo)



Versione **wengè** (base alluminio)



Versione **bianca** (base bianca)

Art. 8758

Misure e prezzi vedi pag. prima



Versione **vintage** (base alluminio)





Art. 8745 1.857,00

- **NORMALMENTE IN PRONTA CONSEGNA**
- MISURE H 76: 97 x 46 aperto 296 x 46 (5 allunghe da L92,5xP50)
- **NOBILITATO HIGH QUALITY - CON SCURETTO DI PREGIO:**
antracite / SERVICE cemento
rovere naturale / SERVICE magnolia NEW



INCREDIBILE!!!!

**Consolle 97x46 aperta 296
 contiene 5 allunghe + 12 sedie
 e gamba di sostegno a scomparsa**



meccanismo alluminio
 TOP QUALITY
 gamba di sostegno integrata

**+ un comodo
 carrellino service**

Sedie pieghevoli (le uniche che permettono 12 pz.):

Art. 8462

- **POLIPROPILENE: bianco - nero - brown 96,00**
 struttura metallo verniciata in tinta
- **IMBALLO N. 4 pz. - Imballo speciale 1/3 pz. + 10,00 netto**
- **NORMALMENTE IN PRONTA CONSEGNA**

consolle + 12 pieghevoli Art. 8462 3.009,00

Per eventuali sedie pieghevoli cliente
 vano interno, tolto spessore allunghe 93x35xH51





cemento

Sedia Art. 8465 vedi pag. 297

Art. 8732

■ **NORMALMENTE IN PRONTA CONSEGNA**

■ MISURE H 76: 85 x 50 aperto 100/150/200
GAMBE vetro temperato 10 mm/NOBILITATO FOLDING:

bianco poro aperto	1.411,00
cemento	1.434,00
pietra grey	1.434,00
rovere nodato	1.434,00



pietra grey



Carrello portallunghe Art. 8752

■ **NORMALMENTE IN PRONTA CONSEGNA**

■ **NOBILITATO BIANCO PORO APERTO**
MISURE: 57 x 18 x H 60 **222,00**

piani realizzati con tecnologia folding
(evita la giunta della fascia col piano, antiestetica)



cemento



rovere nodato



bianco poro aperto



Art. 8730

- **NORMALMENTE IN PRONTA CONSEGNA**
- MISURE H 76: L 90 x P 45/92/139/186 (3 allunghe - 8 posti)
non necessita di sostegno centrale
- NOBILITATO CLEAF cemento **1.187,00**



consolle con
allunghe integrate

Sedia Art. 8465 vedi pag. 297



gamba di sostegno integrata

consolle con
allunghe integrate

Art. 8733

- **NORMALMENTE IN PRONTA CONSEGNA**
- MISURE H 77: 90 x 48 aperto 300
- NOBILITATO FOLDING
bianco poro aperto **1.210,00**





Sedia Art. 8465 vedi pag. 297



Rovere nodato



Carrello portallunghe Art. 8752

- **NORMALMENTE IN PRONTA CONSEGNA**
- **NOBILITATO BIANCO PORO APERTO**
- MISURE: 57 x 18 x H 60 **222,00**



Rovere gessato

Art. 8738

- **NORMALMENTE IN PRONTA CONSEGNA**
- MISURE H 75: 90 x 45 aperto 295 (5 allunghe)
con sostegno centrale integrato (metallo verniciato bianco)
- NOBILITATO FOLDING:

bianco poro aperto	1.053,00
rovere gessato	1.053,00
rovere nodato	1.053,00
antracite NEW	1.053,00



Antracite



Bianco poro aperto



Art. 8725

■ **NORMALMENTE IN PRONTA CONSEGNA**



■ METALLO VERNICIATO: **bianco - antracite - alluminio**

■ MISURE H 76:

■ NOBILITATO:

BIANCO UNITO

**CEMENTO
ROVERE NAT.**

**SOLO STRUTTURA
piano cliente
set cerniere 29,00**

100 x 40 aperta 80	582,00
120 x 40 aperta 80	610,00
140 x 40 aperta 80	650,00
160 x 40 aperta 80	700,00
180 x 40 aperta 80	722,00

605,00
638,00
683,00
728,00 solo cemento
773,00

403,00
414,00
426,00 solo antracite
437,00 solo alluminio - antracite
448,00 solo alluminio - antracite



Sedia Art. 8462 vedi pag. 294



Art. 8749

■ **NORMALMENTE IN PRONTA CONSEGNA**

■ MISURE H 76: 17 x 74 aperto 74 x 128

■ NOBILITATO **bianco** 482,00



Art. 8744

■ **NORMALMENTE IN PRONTA CONSEGNA**

■ MISURE H 76: aperto 70 x 70/140 chiuso profondo 10

■ NOBILITATO **bianco** (struttura alluminio) 616,00
 ■ SOLO STRUTTURA PIANO CLIENTE 437,00



seduta sacco Art. 8832

- **NORMALMENTE IN PRONTA CONSEGNA**
- MISURE: Ø 80 325,00
- RIVESTIMENTO SFODERABILE
ECOPELLE HIGH QUALITY COLORI IN SENSO ORARIO:
viola-argento-bianco-blu-lilla-rosso-verde-tortora



pouf cubo Art. 8830

- **NORMALMENTE IN PRONTA CONSEGNA**
- MISURE: 45 x 45 x h 45 157,00
resistente nella seduta fino a 100 Kg.
- RIVESTIMENTO SFODERABILE
ECOPELLE HIGH QUALITY:
bianco-verde- viola-lilla-tortora-rosso-argento-blu



bianco opaco



sabbia opaco



tortora opaco

Art. 8879/5

- **NORMALMENTE IN PRONTA CONSEGNA**
- OPACO: bianco - sabbia - tortora
- ASTA L 10 x H 165 x P 3 235,00



appendino a scomparsa

Art. 8742

- **NORMALMENTE IN PRONTA CONSEGNA**
- MISURE: aperto 100 x 60
chiuso profondo 8
- NOBILITATO: bianco
- 330,00
(strutture alluminio)



sgabello eliminato



Art. 8964

- IMBALLO N. 1 pz.
- **NORMALMENTE IN PRONTA CONSEGNA**
- ALZO A GAS
- CUSCINO IN TINTA ECOPELLE
- STRUTTURA: CROMATO 197,00
- SEDILI POLIPROPILENE:
verde-turchese-arancio-rosso-nero-bianco-viola-giallo-grigio

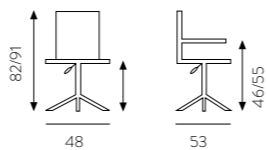

OPTIONAL



Art. 8998 RPQ
set parquet
€ 20,00



Art. 8998 PDF
set fisso
€ 18,00



Art. 8968

- IMBALLO N. 4 pz.
Imballo speciale 1/3 pz. + 10,00 netto
- **NORMALMENTE IN PRONTA CONSEGNA**
- ALZO A GAS
- CUSCINO IN TINTA ECOPELLE
- STRUTTURA NERA 211,00
- SEDILI POLIPROPILENE:
bianco - grigio chiaro



OPTIONAL

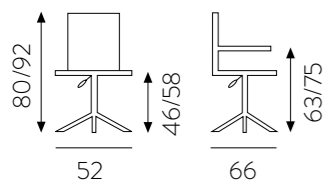

Art. 8998 RPQ
set parquet
€ 20,00



Art. 8998 PDF
set fisso
€ 18,00

Art. 8962

- IMBALLO N. 2 pz.
Imballo speciale 1 pz. + 10,00 netto
- **NORMALMENTE IN PRONTA CONSEGNA**
- STRUTTURA NERA 197,00
- SEDILI POLIPROPILENE:
celeste - grigio

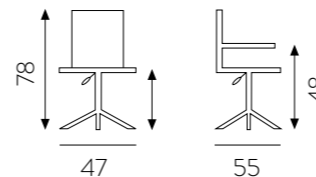



Art. 8944

- IMBALLO N. 1 pz.
- **NORMALMENTE IN PRONTA CONSEGNA**
- SEDILE GIREVOLE CON ALZO A GAS - BASE NYLON
- BRACCIOLI INCLUSI
- SEDUTA FISSA - SCHIENALE CONTATTO PERMANENTE CON UP-DOWN
- TESSUTO **ACRIPOL ROSSO** 219,00
- TESSUTO **ACRIPOL NERO** 255,00

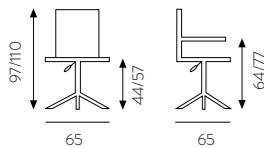

OPTIONAL



Art. 8998 RPQ
set parquet
€ 20,00

Art. 8998 PDF
set fisso
€ 18,00



Art. 8931

- IMBALLO N. 1 pz.
- **NORMALMENTE IN PRONTA CONSEGNA**
- SEDILE GIREVOLE CON ALZO A GAS
- MECCANISMO BASCULANTE
- **STRUTTURA**
- **SCHIENALE: TECNORETE MICROFORATA**
- **SEDILI: PUMA NERO**

CROMATO

255,00

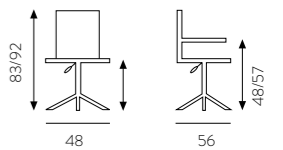

OPTIONAL



Art. 8998 RPQ
set parquet
€ 20,00

Art. 8998 PDF
set fisso
€ 18,00



Art. 8938

- **IMBALLO N. 1 pz.**
- **NORMALMENTE IN PRONTA CONSEGNA**
- **SEDILE GIREVOLE CON ALZO A GAS - BASE DESIGN**
- **REGOLAZIONE SYNCRON** (sedile/schienale bloccabile 4 posizioni) con antishok per evitare, dopo lo sblocco, l'impatto brusco sulla schiena
- **TESSUTO TECNICO / RETE NERO** **388,00**

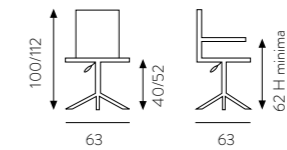

- OPTIONAL
- Art. 8998 RPQ set parquet **20,00**
 - Art. 8998 PDF set fisso **18,00**



poggiatestiere regolabile



bracciolo regolabile

Art. 8937

- **IMBALLO N. 1 pz.**
- **NORMALMENTE IN PRONTA CONSEGNA**
- **SEDILE GIREVOLE CON ALZO A GAS - BASE DESIGN**
- **SEDUTA FISSA - BRACCIOLI REGOLABILI E TRASLANTI**
- **TESSUTO TECNICO / RETE NERA** **276,00**

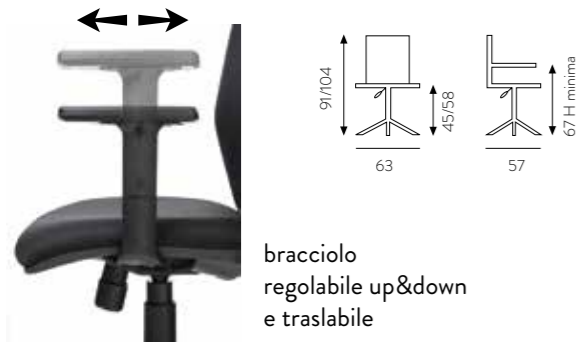

bracciolo regolabile up&down e traslabile

OPTIONAL



Art. 8998 RPQ
set parquet
20,00



Art. 8998 PDF
set fisso
18,00



poltroncina interlocutore/attesa Art. 8988

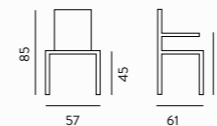

- **IMBALLO N. 2 pz.**
- **Imballo speciale 1 pz. + 10,00 netto**
- **NORMALMENTE IN PRONTA CONSEGNA**
- **STRUTTURA NERA / STOFFA nera** **320,00**



Tavolo Art. 8673 vedi pag. 61



poggiatesta regolabile

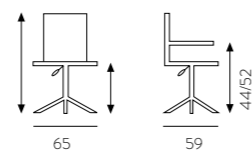

meccanismo sincron
regola inclinazione
sedile/schienale

Art. 8927

- IMBALLO N. 1 pz.
- **NORMALMENTE IN PRONTA CONSEGNA**
- SEDILE GIREVOLE CON ALZO A GAS
- MECCANISMO SINCRON
- STRUTTURA
- SCHIENALE: TECNORETE MICROFORATA
- SEDILI: PUMA NERO

381,00



alzo a gas

OPTIONAL



Art. 8998 RPQ
set parquet
€ 20,00



Art. 998 PDF
set fisso
€ 18,00



- IMBALLO N. 1 pz.
- **NORMALMENTE IN PRONTA CONSEGNA**
- SEDILE GIREVOLE CON ALZO A GAS
- MECCANISMO SINCRON (regolazione inclinazione sedile/schienale)
- BRACCIOLI REGOLABILI IN ALTEZZA E ORIZZONTALMENTE
- POGGIARENI REGOLABILE
- STRUTTURA NYLON NERO
- SCHIENALE TECNORETE MICROFORATA
- SEDILE nero

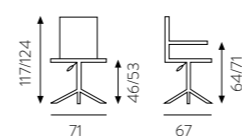

Art. 8925/A alta 443,00

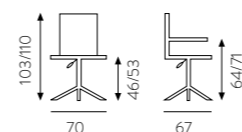

Art. 8925/B bassa 421,00
senza poggiatesta



OPTIONAL



Art. 8998 RPQ
set parquet
20,00



Art. 8998 PDF
set fisso
18,00



- SEDILE GIREVOLE CON ALZO A GAS
- MECCANISMO BASCULANTE
- STRUTTURA CROMATA
- SEDILI / SCHIENALE ECOPELLE: bianco - nero - grigio titanio

Art. **8928/A** alta 649,00

Art. **8928/B** bassa 627,00

NORMALMENTE IN PRONTA CONSEGNA

OPTIONAL



Art. 8998 RPQ
set parquet
€ 20,00

Art. 8998 PDF
set fisso
€ 18,00

NERO



GRIGIO TITANIO



BIANCO



Art. 8923

- IMBALLO N. 1 pz.
- **NORMALMENTE IN PRONTA CONSEGNA**
- SEDILE GIREVOLE CON ALZO A GAS
- MECCANISMO BASCULANTE
- BASE: IN FUSIONE CROMATA
- SCHIENALE: ECOPELLE
- SEDILI: PELLE nera

627,00

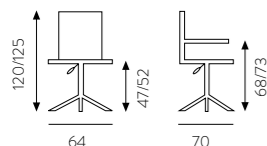

appendiabiti Art. 8864

- IMBALLO N. 1 pz.
 - **NORMALMENTE IN PRONTA CONSEGNA**
 - POLIPROPILENE / ALLUMINIO NERO
 - MISURE: Ø 47 x H 174
- 152,00



Art. 8981 Poltroncina interlocutore/riunione/attesa

L58-P59-HS45-HB62-HT81

- IMBALLO N. 2 pz.
Imballo speciale 1 pz. + 10,00 netto
 - **NORMALMENTE IN PRONTA CONSEGNA**
 - STRUTTURA: CROMATO
 - SEDILI: ECOPELLE nera - bianca
- 428,00

Art. 8302 Poltroncina interlocutore

L58-P59-HS45-HB62-HT81

- IMBALLO N. 2 pz.
Imballo speciale 1 pz. + 10,00 netto
 - **NORMALMENTE IN PRONTA CONSEGNA**
 - STRUTTURA: CROMATO
 - SEDILI: CUOIO RIGENERATO nero
- 255,00



Art. 8926

- IMBALLO N. 1 pz.
 - **NORMALMENTE IN PRONTA CONSEGNA**
 - SEDILE GIREVOLE CON ALZO A GAS
 - MECCANISMO RECLINABILE
 - BASE CROMATA
 - SCHIENALE: ECOPELLE
 - SEDILI: ECOPELLE nera
- 549,00

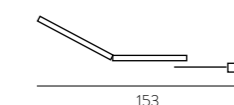
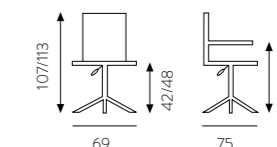

OPTIONAL



Art. 8998 RPQ
set parquet
€ 20,00



Art. 8998 PDF
set fisso
€ 18,00



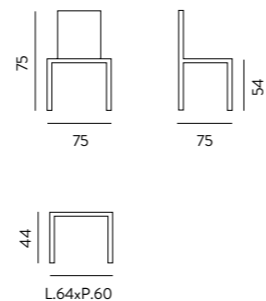

tavolino eliminato

- IMBALLO N. 1 pz.
- **NORMALMENTE IN PRONTA CONSEGNA**
- STRUTTURA: CROMATA
- SEDILI ECOPELLE: bianco nero
- Art. 8427/1 POLTRONA 997,00 997,00
- Art. 8427/2 POUF 549,00 549,00



Art. 8987
L52-P52-HS45-HT80
struttura **cromata**/ABS ignifugo **nero**
88,00
dotata di gancio saldato
per allineamento file

NORMALMENTE IN PRONTA CONSEGNA

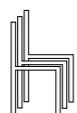

Art. 8982/P
TEMPI 30/40 GG.
acripol ignifugo: **blu-rosso-nero**
ecopelle ignifuga **nera**

- 2 MODULI L. 110-P. 62 **694,00**
- 3 MODULI L. 165-P. 62 **907,00**
- 4 MODULI L. 220-P. 62 **997,00**

Per modulo si intende o seduta o tavolino



Art. 8982
L66-P58-HS43-HT82
acripol ignifugo: **rosso-nero** **100,00**

bracciolo con tavoletta **+ 55,00**
coppia braccioli **+ 43,00**

NORMALMENTE IN PRONTA CONSEGNA

- IMBALLO N. 1 pz.
- STRUTTURA: METALLO TUBOLARE 3X3 ACCIAIO LUCIDO
- RIVESTIMENTO ECOPELLE: bianco - nero
- Art. 8434/1 POLTRONA 1P **974,00**
L80-P70-H68
- Art. 8434/2 DIVANO 2P **1.422,00**
L130-P70-H68



Art. 81065

- **NORMALMENTE IN PRONTA CONSEGNA**
- INGOMBRO TERRA GAMBA 76
- POLIPROPILENE Nero
- SOLO BASE per piano: 150/200 x 80/90 max
616,00

NOTA TECNICA
azionando leva di chiusura, con il ribaltamento del piano, in automatico le gambe divaricano, permettendo di riporre i tavoli in spazi contenuti (vedi foto)





RICHIEDI VIA MAIL IL PROGRAMMA COMPLETO OUTDOOR

RICHIEDI VIA MAIL IL PROGRAMMA COMPLETO OUTDOOR

CEDI Spa

Sede Operativa:

Via F.lli Bandiera 9 - 80026 - Casoria (NA)

Uff. Commerciale: Tel. 081.5844781

Uff. Amministrazione: Tel. 081.5846368

Deposito: Tel. 081.5844808

info@cedispa.it - www.cedispa.it

Filiale di Pescara:

Via Lago di Chiusi, 4

65128 - Pescara (PE)

Tel. 085.50899

infopescara@cedispa.it

Filiale di Pesaro:

Strada Fornace Vecchia, 6

61122 - Pesaro (PU)

Tel. 0721.205866

infopesaro@cedispa.it

Filiale Barberino Tavarnelle:

Uffici e ShowRoom: Via Pisana, 35

50028 - Barberino Tavarnelle (FI)

Tel: (+39) 055 807991

infobarberino@cedispa.it