

KITCHEN EXPERIENCE

PLADOS

LISTINO PREZZI 2024 - 2025

INDICE GENERALE



AZIENDA	8
LAVELLI	40
Selezione Rinnova	42
Contempo	54
Lux	60
Cosmo	68
One	74
Elegance	100
Infinity	108
Corax	114
Atlantic	122
Spazio	130
Harmony	138
LAVELLI INOX	146
ACCESSORI	162
MISCELATORI	180
FORNI	220
PIANI COTTURA A INDUZIONE	228
PIANI COTTURA A GAS	234
GAMMA COLORI	246

90 cm

80 cm

60 cm



















**CONTEMPO/
LUX****CT9010**
Pag. 58**LX8610**
Pag. 64**LX8620**
Pag. 66**COSMO****C07510**
Pag. 72**C05510**
Pag. 72**ONE**Installazione
standard**ON8420**
Pag. 78**ON8410**
Pag. 78**ON8620**
Pag. 79**ON7920**
Pag. 79**ON7610**
Pag. 80**ON6910**
Pag. 80**ON6010**
Pag. 81**ON5610**
Pag. 81**ON6010**
Pag. 81**ONE**Installazione
sotto-top**ON8420ST**
Pag. 88**ON8410ST**
Pag. 88**ON7920ST**
Pag. 89**ON7610ST**
Pag. 90**ON6910ST**
Pag. 91**ON5610ST**
Pag. 92**AM8620ST**
Pag. 89**LX8610ST**
Pag. 90**ON6010ST**
Pag. 91**ONE**Installazione
integrata**ON7610IT**
Pag. 98**ON5610IT**
Pag. 98**ELEGANCE****AM8620**
Pag. 105**AM11620**
Pag. 104**AM9915**
Pag. 104**AM9910**
Pag. 105**AM7815**
Pag. 107**INFINITY****NF11620**
Pag. 112**NF9910**
Pag. 112**NF8610**
Pag. 113**CORAX****CX0862**
Pag. 119**CX1162**
Pag. 118**CX0991**
Pag. 118**EL9910**
Pag. 119**ATLANTIC****PL1162**
Pag. 126**PL0862**
Pag. 127**AT1162**
Pag. 126**SPAZIO****SP0862**
Pag. 134**SP1162**
Pag. 134**SP0792**
Pag. 135**HARMONY****HR0860**
Pag. 143**DB09910**
Pag. 142**PL11610**
Pag. 142**DB09910**
Pag. 142

50 cm



























45 cm

40 cm

Angolare

50 cm	45 cm	40 cm	Angolare	
				CONTEMPO/ LUX
 C04510 Pag. 73	 C04510 Pag. 73			COSMO
	 ON4110 Pag. 82			ONE Installazione standard
	 ON4110ST Pag. 92			ONE Installazione sotto-top
				ONE Installazione integrata
   AM8610 AM7810 AM6510 Pag. 106 Pag. 106 Pag. 107				ELEGANCE
				INFINITY
	  CX0861 CX0791 Pag. 120 Pag. 120			CORAX
	  PL0861 PL4351 Pag. 127 Pag. 128	 PL4351 Pag. 128	 FTA8320 Pag. 128	ATLANTIC
	  SP0861 SP0791 Pag. 135 Pag. 136			SPAZIO
 HR4321 Pag. 143 Installazione longitudinale	  HR4321 NK05110 Pag. 143 Pag. 144 Installazione standard		 HRA832 Pag. 144 Inseribile anche in 2 basi rettangolari da 90 cm	HARMONY

LAVELLI IN ACCIAIO INOX

	90 cm	80 cm	60 cm	50 cm	45 cm	Angolare
MAKI MIX-R Installazione slim/filo-top		 SR7520 Pag. 151  SR7500 Pag. 151	 SR5500 Pag. 151		 SR3900 Pag. 151	
MAKI-R Installazione slim/filo-top		 MR7420 Pag. 153  MR7400 Pag. 153	 MR5400 Pag. 153		 MR3800 Pag. 153	
MAKI ST-R Installazione sotto-top		 SL7420 Pag. 155  SL7400 Pag. 155	 SL5400 Pag. 155		 SL3800 Pag. 155	
OLYMPUS/ VINTAGE	 C008620 Pag. 157	 C01162 Pag. 157  VI1001 Pag. 157  C007920 Pag. 158  VI08600 Pag. 158	 VI1001 Pag. 157		 C00861 Pag. 157  C00791 Pag. 158  LISP000431S Pag. 158  LISP504410S60 Pag. 159	 LISP838320S Pag. 159  VIA832 Pag. 159
UNIVERSAL	 TL08620 Pag. 161	 TL1162 Pag. 161			 TL0861 Pag. 161	

ACCESSORI



**COPRIVASCA
IN HPL**
pag. 166



**ACCESSORI
COORDINATI**
pag. 167-171



**ACCESSORI
DESIGN**
pag. 173



**TAGLIERI IN LEGNO,
POLIETILENE,
CRISTALLO**
pag. 174-175



**VASCHETTE
IN POLICARBONATO
E ACCIAIO INOX**
pag. 176



TRITARIFIUTI
pag. 177



**PRODOTTI PER
LA PULIZIA**
pag. 178



ALTRI ACCESSORI
pag. 179

MISCELATORI



SORGENTE 1
pag. 187



SORGENTE 2
pag. 187



FLO55
pag. 188



FLO60
pag. 188



KIT FILTRANTE
pag. 189



POLYTEK10
pag. 191



POLYTEK20
pag. 191



HEGO
pag. 192



SHOWERMID
pag. 192



SPRINGP30
pag. 194



SPRINGP40
pag. 194



NEWMIX80
pag. 196



NEWMIX90
pag. 196



NEWMIX30
pag. 198



MIG10
pag. 198



SPIRIT
pag. 200



NILO
pag. 200



NEMO
pag. 202



COLONNA
pag. 204



HYDRA
pag. 206



VEMIXEXTL
pag. 206



PARMIXEXT
pag. 208



PUNTOBPEX
pag. 208



VENMIXEXT
pag. 210



TIZMIXEXT
pag. 210



SLIMFIX
pag. 211



VENMIXL
pag. 211



TIZEK
pag. 212



EASY
pag. 212



PETRAMIX
pag. 213



VENMIX20
pag. 213



EUROMIX
pag. 214



NEOMIX
pag. 214



PLUSMIX
pag. 215



PLUSMIXEXT
pag. 215



WINMIX
pag. 216



NOVOMIX
pag. 216



MIXOLDST
pag. 216



MIXOLD
pag. 218



IDEAOLD
pag. 218

ELETTRODOMESTICI



FIDIG
pag. 224



FIMOD
pag. 225



FITER
pag. 226



PBIL320C
pag. 232



PBIM430
pag. 232

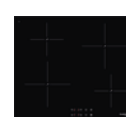

PBIM640C
pag. 233



GLASS75
pag. 238



GLASS60
pag. 238



SLIM75
pag. 239



FLAT75
pag. 240



FLAT60
pag. 241



STAR75
pag. 242



STAR60
pag. 243



**30 ANNI
DI STORIA
E DI TERRITORIO**

LE NOSTRE **RADICI - LE MARCHE**

30 ANNI DI STORIA E DI TERRITORIO

Il *chi* e il *come* sono importanti ma anche il *dove* conta. Il nostro *dove* è l'infinito naturale delle Marche; è appartenenza alla lunga tradizione d'eccellenza del "saper fare" delle mani, a un'operosità generosa e tenace.

Essere qui e non altrove ha fatto la differenza, perché siamo parte integrante di questa geografia fisica e umana, perché l'appartenenza è una relazione tra azienda e territorio che genera valore in termini di sviluppo e competitività e crea beneficio alla comunità in termini di benessere e qualità della vita. Essere nel territorio e non sul territorio, scegliere una terra buona nella quale mettere radici ha significato potersi nutrire di quanto essa offre, crescere e svilupparsi in modo solido.

RICERCA E SVILUPPO

UNA VISIONE DI FUTURO



Avere una visione significa immaginare il futuro che vogliamo contribuire a creare per noi e per gli altri, facendo pratica dei valori, degli ideali e dei desideri che ci distinguono.

Nella nostra visione di futuro, la conoscenza è la stella che guida il nostro cammino. Non c'è innovazione senza conoscenza, non c'è cambiamento o miglioramento concreto che possa riguardare la progettazione, la produzione e la vendita di beni se non con l'impegno a fare della conoscenza un processo continuo di ricerca e scoperta.

30 anni di Plados sono stati questo, una tensione fino a quell'orizzonte e poi un altro e un altro ancora, senza smettere mai di pensare che si può fare meglio di come abbiamo fatto.



↓
**3500 M²
DEDICATI**





↓
**250 PERSONE
NEL MONDO
LAVORANO
PER PLADOS**



PERSONE E VALORI

DARE SENSO ALL'IMPRESA



Le persone che hanno le competenze fanno di un'azienda una grande azienda; le persone che hanno le competenze e la passione fanno di un'azienda un progetto. E sono le persone, la loro mentalità, la loro capacità di combinare mezzi e risorse a realizzare quel progetto.

Le nostre persone, ciascuna di loro, sono orientate da un progetto comune e impegnate nella sua realizzazione: ogni persona che in questi 30 anni di storia ha scelto di fare suoi i nostri valori e condividere la nostra idea di essere e fare impresa, si è dedicata con entusiasmo e impegno costante, è un patrimonio prezioso, una risorsa strategica, un facilitatore della nostra visione di futuro. Tutte le persone di Plados, ciascuna con le proprie competenze, sono la condizione necessaria per dare senso al fare impresa.

RIVOLUZIONE **GREEN**

IL FUTURO È NELLE MANI DI TUTTI

Oltre all'impegno per ridurre i consumi di energia, Plados ha introdotto misure per coprire il proprio fabbisogno energetico tramite fonti rinnovabili. L'azienda ha recentemente installato un impianto fotovoltaico sui tetti dei propri stabilimenti. L'energia solare generata da tale impianto eviterà l'emissione di 300 tonnellate di anidride carbonica ogni anno. Si può stimare che sarebbero necessari circa 20.000 Alberi per assorbire la suddetta quantità di CO₂ evitata.



Consumi elettrici coperti dal fotovoltaico.



300 Tonnellate/anno di emissioni CO₂ in meno.



Alberi necessari per assorbire la CO₂ evitata.

↓
40%
AUTOPRODUZIONE



RIVOLUZIONE **GREEN**

LA MATERIA PRIMA, I PROCESSI PRODUTTIVI,
LE RISORSE, IL PRODOTTO

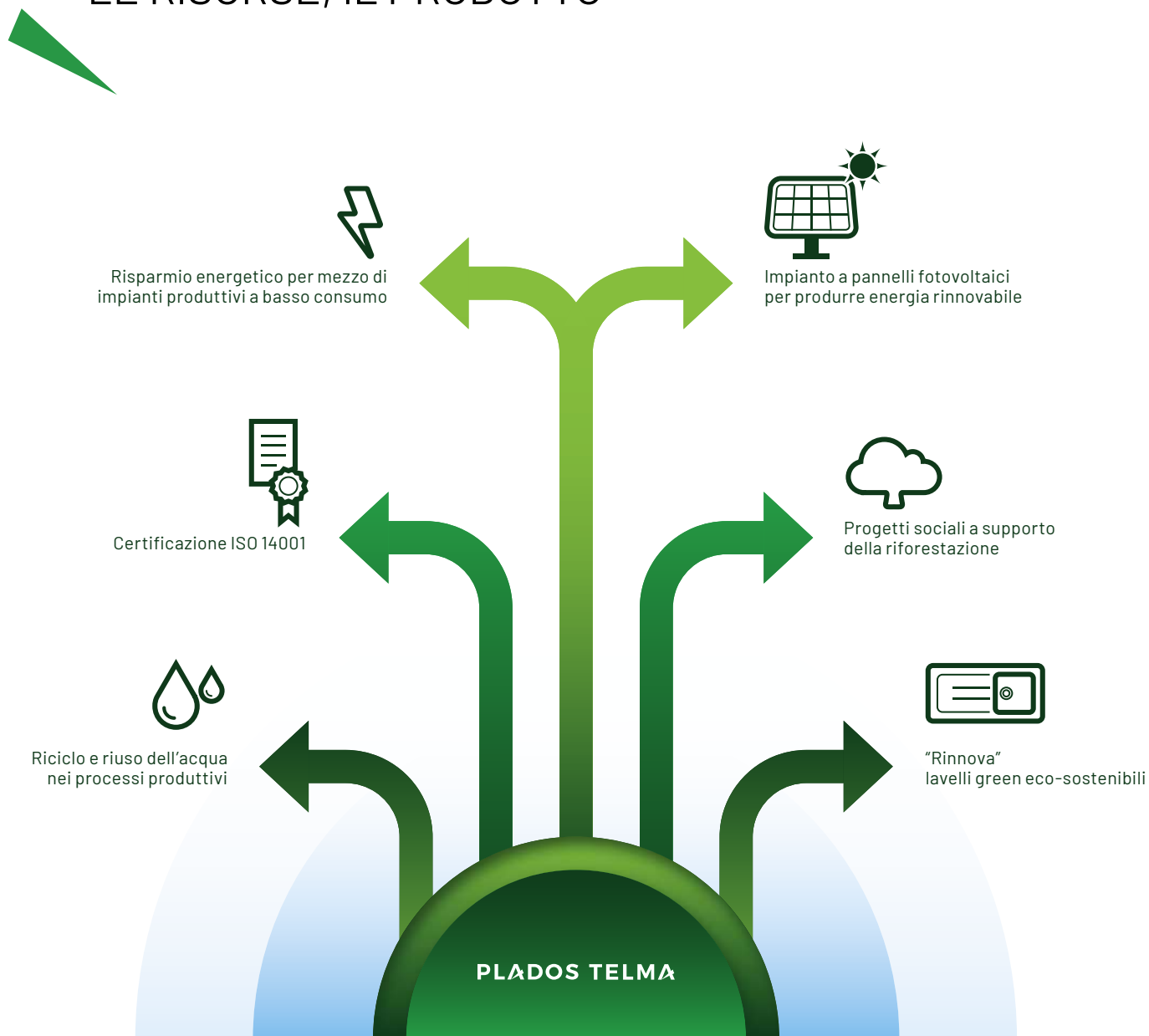

Natura, persone ed economia sono i termini connessi e interdipendenti di una stessa relazione; agire per l'ambiente significa generare crescita di valore per le comunità di tutto il mondo. Per questa ragione, l'impegno green di Plados Telma investe l'origine della materia prima, i processi produttivi, l'impiego efficiente delle risorse energetiche e idriche, il prodotto e il suo ciclo di vita; per costruire una sostenibilità d'impresa, per l'ambiente e per le persone.





**ISO 14001
GARANTISCE
PER CHI
CI SCEGLIE**

IL NOSTRO IMPEGNO **CERTIFICATO** SECONDO LO STANDARD INTERNAZIONALE DEL SISTEMA DI GESTIONE AMBIENTALE



Le certificazioni rappresentano un elemento fondamentale del nostro fare impresa perché costituiscono una garanzia di rispetto delle normative di legge, sia per noi che per le persone che ci scelgono.

La ISO14001 certifica che Plados è dotata di un sistema di gestione adeguato al controllo dell'impatto ambientale delle proprie attività e certifica l'impegno costante dell'azienda a migliorare quell'impatto in modo efficace e sostenibile. La certificazione ISO14001 non è obbligatoria, ma è frutto della scelta volontaria dell'azienda che decide di definire, attuare, mantenere e migliorare un proprio sistema di gestione ambientale.

L'anima green di Plados corre lungo tutta la catena del valore, dall'approvvigionamento della materia prima alla realizzazione di prodotti che consentono di risparmiare sulle risorse idriche ed energetiche. Chi sceglie Plados può contare sulle nostre buone pratiche ambientali.

PLADOS **ARIAPURA**

LA TECNOLOGIA CHE PORTA IL CIELO IN CUCINA

Il materiale dei lavelli Plados è addizionato con nanoparticelle di biossido di titanio (TiO_2) che oltre a contribuire alla purificazione dell'aria nell'ambiente cucina, svolge un'azione antibatterica rendendo il lavello più fresco e più pulito. Ariapura è presente in tutta la massa del lavello, ha una durata illimitata, resta attiva e conserva la sua completa efficacia nel tempo anche in caso di usura e graffio delle superfici.

Tutti i lavelli Plados sono provvisti della tecnologia brevettata ariapura che svolge una triplice azione:

- Antinquinante
- Antibatterica
- Autopulente

**BREVETTO INTERNAZIONALE
PCT/EP2012 /065120**



↓

AZIONE ANTINQUINANTE ANTIBATTERICA AUTOPULENTE



NUOVE ESPERIENZE IN CUCINA

PLADOS: KITCHEN **EXPERIENCE** COME CAMBIA L'APPROCCIO AL QUOTIDIANO



Kitchen experience è la nostra filosofia dell'abitare gli spazi domestici: progettiamo e realizziamo prodotti per cucine che possano essere vissute come luogo d'incontro e socialità, belli da vedere e funzionali, capaci di durare nel tempo, accessibili a tutti, perché la qualità è un lusso che tutti devono potersi permettere; rispettosi dell'ambiente, perché le nostre case confinano con una casa più grande, il nostro pianeta.

Kitchen experience riassume il nostro impegno a migliorare concretamente lo stile di vita delle persone, perché il tempo trascorso in cucina e ogni gesto siano esperienza di buona vita, benessere, salute, cura e attenzione, per noi e la natura.

Kitchen experience è il nostro contributo a un futuro migliore, per tutti.



CONTEMPO

COUNTRY REIMAGINED



NUOVI MISCELATORI

DESIGN & RISPARMIO ENERGETICO



MISCELATORI
A TRE VIE:
ADDIO BOTTIGLIE DI PLASTICA



LAVELLO WORKSTATION

TUTTO SOTTO CONTROLLO

Il lavello workstation è una vera e propria postazione di lavoro, più spaziosa, pratica e funzionale grazie agli accessori integrati studiati ad hoc: cestelli, vassette, taglieri, dispenser e molto altro. I materiali e le finiture di pregio fanno del lavello workstation un elemento di arredo capace di aggiungere valore estetico alla cucina. LX8610 è la risposta di Plados al desiderio di trasformare la cucina in un luogo di esperienza, nel quale design e funzionalità si uniscono per migliorare la qualità del tempo che vi trascorriamo.



ROLLMAT

Un gocciolatoio pieghevole con barre a sezione rettangolare, per una maggiore stabilità. Disponibile in 4 finiture.

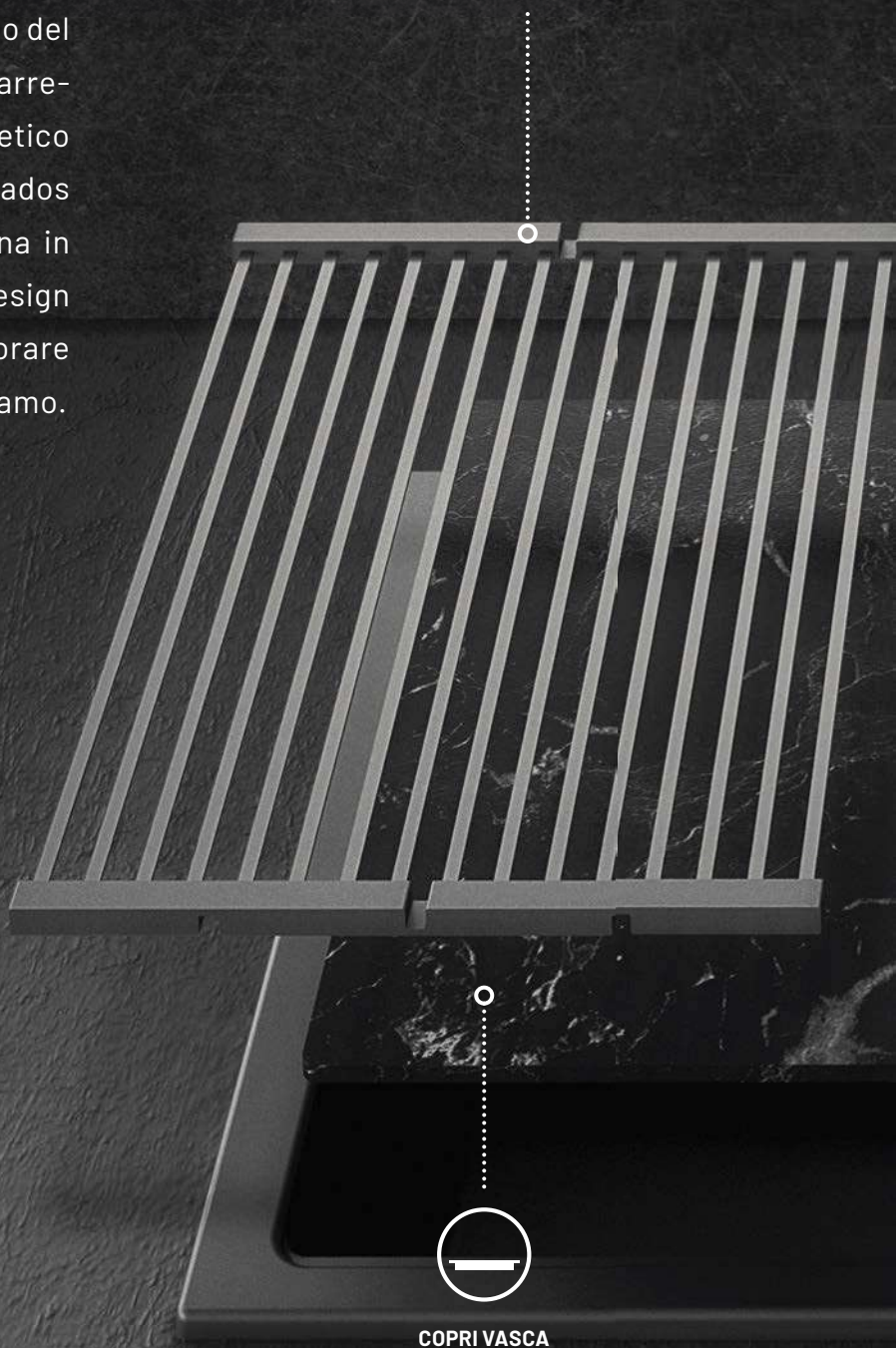

COPRI VASCA

Una pratica superficie aggiuntiva, utile durante la preparazione dei cibi, ideale per i lavelli sprovvisti di gocciolatoio.



DISPENSER SAPONE LIQUIDO

Si installa in uno dei prefori presenti nel lavello. Una soluzione di design pratica e funzionale.



VASCHETTA IN POLICARBONATO

Progettata per scorrere sulle guide dei lavelli LUX, un accessorio pratico ed elegante, sempre utile nella preparazione dei cibi.



PILETTA PVD

Una finitura high-tech raffinata e resistente.

TRASFORMA LA TUA CUCINA

FINITURE PVD

PVD è l'acronimo di Physical Vapor Deposition, una tecnologia che consente di depositare un rivestimento metallico su diversi tipi di superfici. I rivestimenti in PVD oltre ad avere eccezionali caratteristiche estetiche, sono particolarmente indicati per tutti quei prodotti che necessitano di elevate prestazioni di resistenza all'abrasione, al graffio e alla corrosione.

Le nuovissime finiture metalliche in PVD permettono di creare abbinamenti di altissimo pregio tra pilette, miscelatori e accessori di design.



PVD - ORO

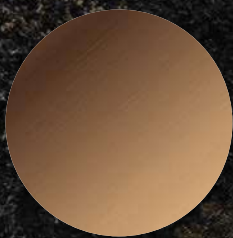

PVD - RAME



PVD - GUN METAL





Il nuovissimo miscelatore NEMO (pag. 202) è disponibile anche in 3 finiture PVD abbinabili sia ai KIT piletta e troppopieno PVD, che all'accessorio ROLLMAT, sempre in tinta.





I coordinati rappresentano l'unione tra funzionalità ed estetica: materiali, forme e colori dialogano in equilibrio perfetto e fanno della cucina un'esperienza anche sensoriale, tutta da vivere.

COORDINATI

L'EQUILIBRIO TRA
FUNZIONALITÀ ED ESTETICA



LAVELLO + RUBINETTO + ELETTRODOMESTICI COORDINATI PER **AMBIENTAZIONI CLASSICHE**

Abbinamenti **colore dei lavelli e rubinetti** Plados
con piani cottura e forni dei principali fabbricanti di **elettrodomestici**

FINITURE PLADOS



microULTRAGRANIT
56 Jasmine



microULTRAGRANIT
70 Nero Matt



microULTRAGRANIT
90 Bianco Opale



microULTRAGRANIT
94 Avena



microULTRAGRANIT
95 Nero Ebony

COLORI DEI
PRINCIPALI
FABBRICANTI DI
ELETTRODOMESTICI

HOTPOINT	OW BIANCO ANTICO	AN ANTRACITE	GW GRANITO BIANCO	AV AVENA	
INDESIT		AN ANTRACITE		AV AVENA	
ELECTROLUX	PBA BIANCO ANTICO	• PN NERO GHISA • NERO	PP PIETRA	PS SABBIA	PL LAVA
WHIRLPOOL	BIANCO ANTICO	ANTRACITE		AVENA	
SMEG	PANNA	ANTRACITE NERO		AVENA	
CANDY	BA BIANCO ANTICO	• GH GHISA • N NERO		AV AVENA	PL LAVA
FRANKE		NERO	BIANCO	AVENA	GRAFITE
TELMA	TG 51 JASMINE	TG 26 NERO MATT	TG 31 BIANCO	TG 29 AVENA	TG 30 NERO
BEKO		• ANTRACITE • NERO		AVENA	
FOSTER	AVORIO	ANTRACITE		AVENA	
DE'LONGHI		ANTRACITE		• AVENA • SABBIA	
GLEM GAS		• ANTRACITE • NERO		SABBIA	

LAVELLO + RUBINETTO + ELETTRODOMESTICI COORDINATI PER **AMBIENTAZIONI MODERNE**

Abbinamenti **colore dei lavelli e rubinetti** Plados
con piani cottura e forni dei principali fabbricanti di **elettrodomestici**

FINITURE PLADOS



microULTRAGRANIT 98 Bianco microULTRAGRANIT 70 Nero Matt microULTRAGRANIT 72 Tartufo ULTRAMETAL 41 Alluminio ULTRAMETAL 42 Titanio ULTRAMETAL 44 Nero nanoSTONE N1 Bianco Latte nanoSTONE N6 Deep Black

COLORI DEI
PRINCIPALI
FABBRICANTI DI
ELETTRODOMESTICI

HOTPOINT/ ARISTON	• WH BIANCO • CRISTALLO BIANCO	• MR SPECCHIO • CRISTALLO NERO	DS DESERT SAND	• SL ARGENTO • INOX	• IC ICE • INOX	• MR SPECCHIO • INOX	CRISTALLO BIANCO	CRISTALLO NERO
INDESIT	• WH BIANCO • VETRO BIANCO	• BK NERO • VETRO NERO	TD TORTORA	INOX	• GR GRAFITE • INOX	• BK NERO • INOX	VETRO BIANCO	VETRO NERO
ELECTROLUX/ REX	• BIANCO • CRISTALLO BIANCO	• NERO • CRISTALLO NERO		INOX	INOX	• SPECCHIO • INOX	VETRO BIANCO	VETRO NERO
WHIRLPOOL	• BIANCO VETRO BIANCO	• ANTRACITE • VETRO NERO	VETRO TORTORA	• VETRO SILVER • INOX	INOX	• VETRO SPECCHIO • INOX	VETRO BIANCO	VETRO NERO
SMEG	• BIANCO • VETRO BIANCO	• ANTRACITE • VETRO NERO		• VETRO SUPERSILVER • INOX	INOX	INOX	VETRO BIANCO	VETRO NERO
CANDY	• W BIANCO • CRISTALLO BIANCO	• N NERO • CRISTALLO NERO		• SPARK AQUA • INOX	INOX	• CRISTALLO SPECCHIO • INOX	VETRO BIANCO	VETRO NERO
FRANKE	• BIANCO • CRISTALLO BIANCO	• NERO • CRISTALLO NERO	CRISTALLO CHAMPAGNE	• ALLUMINIO • INOX	INOX	• MIRROR NERO • INOX	CRISTALLO BIANCO	MIRROR NERO
TELMA	TG 28 BIANCO LATTE	TG 26 NERO MATT	TG 54 TARTUFO	• MQ 71 ALLUMINIO	• MQ 72 TITANIO	INOX		
BEKO		• ANTRACITE • NERO		INOX	INOX	INOX		
FOSTER	BIANCO	ANTRACITE		INOX	INOX	INOX		
DE'LONGHI	BIANCO	NERO	TORTORA	INOX	• SPECCHIO • INOX	INOX		
GLEM GAS	• BIANCO • CRISTALLO BIANCO	• NERO • CRISTALLO NERO		• ALLUMINIO • INOX	INOX	INOX	CRISTALLO BIANCO	CRISTALLO NERO
IGNIS	BIANCO	NERO	TORTORA	INOX	INOX	INOX		
SIEMENS	• BIANCO • VETRO BIANCO	• NERO • VETRO NERO		INOX	INOX	INOX	VETRO BIANCO	VETRO NERO
BOSCH	• BIANCO • VETRO BIANCO	• NERO • VETRO NERO		INOX	INOX	INOX	VETRO BIANCO	VETRO NERO



FINITURE E QUALITÀ

DEI PRODOTTI PLADOS



Plados ha messo al centro la qualità del prodotto e ha voluto renderla accessibile a tutti. Un impegno che ci ha permesso di ottenere importanti riconoscimenti a livello nazionale e internazionale e soprattutto la fiducia dei nostri clienti.

Produrre oggetti di qualità risponde anche a una precisa filosofia dell'abitare, coerente con la salute delle persone e dell'ambiente. L'intera catena del valore, la ricerca e l'impiego di tecnologie e materiali innovativi, riflettono la volontà di ridurre l'impatto dei processi produttivi e allungare il ciclo di vita degli oggetti: un gesto di cura e di rispetto per il pianeta e per le persone a cui sono destinati i nostri prodotti.

Plados produce lavelli di ottima qualità destinati a durare nel tempo con la convinzione che la durabilità sia un aspetto della qualità da cui non si può prescindere.

FINITURE E QUALITÀ / RINNOVA



Attraverso un processo di **rigenerazione delle materie prime di recupero**, abbiamo ottenuto un composto green all'origine che garantisce le stesse caratteristiche chimiche, fisiche, meccaniche ed estetiche rispetto al composto tradizionale dei lavelli Plados. Il nostro obiettivo era **massimizzare l'impiego di queste risorse, altrimenti destinate alla discarica**, così da non ricorrere a materie prime vergini. La qualità del prodotto finale è identica, la differenza la fa l'origine della materia prima, **i lavelli Rinnova sono composti da più del 90% di componenti rinnovabili**.



FINITURE E QUALITÀ / NANOSTONE



NanoSTONE è composto da resina acrilica purissima e da un mix di cariche minerali high-tech, progettate per legarsi tra loro sviluppando un reticolo 3D di "legami idrogeno", mediante un processo chimico possibile grazie alle geometrie e alla polarizzazione dei minerali coinvolti. La rete molecolare così creata, **fortifica la struttura interna del lavello, rendendolo più resistente agli urti ed agli shock termici**. Il nuovo materiale composito ha una struttura più robusta e una sensazione di piacevolezza al tatto.

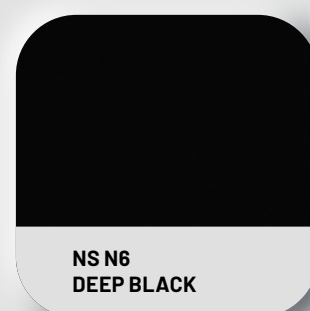
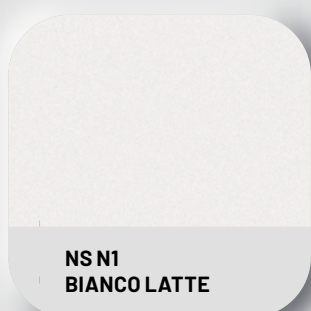

FINITURE E QUALITÀ / **ULTRAMETAL**



Le **particelle metallescenti**, presenti nella miscela assieme a cristalli di quarzo e granito, creano nelle superfici del lavello **tonalità e finiture metallizzate**. Colorazioni fredde, superfici satinata ed effetto metallescente rendono il lavello in Ultrametal particolarmente idoneo per **ambientazioni moderne** e per abbinamenti con elettrodomestici in acciaio inox, spesso presenti in cucina. Un lavello in Ultrametal è facile da pulire, molto igienico e resistente ai graffi, agli agenti chimici, al calore ed alle alte temperature.



FINITURE E QUALITÀ / MICROULTRAGRANIT

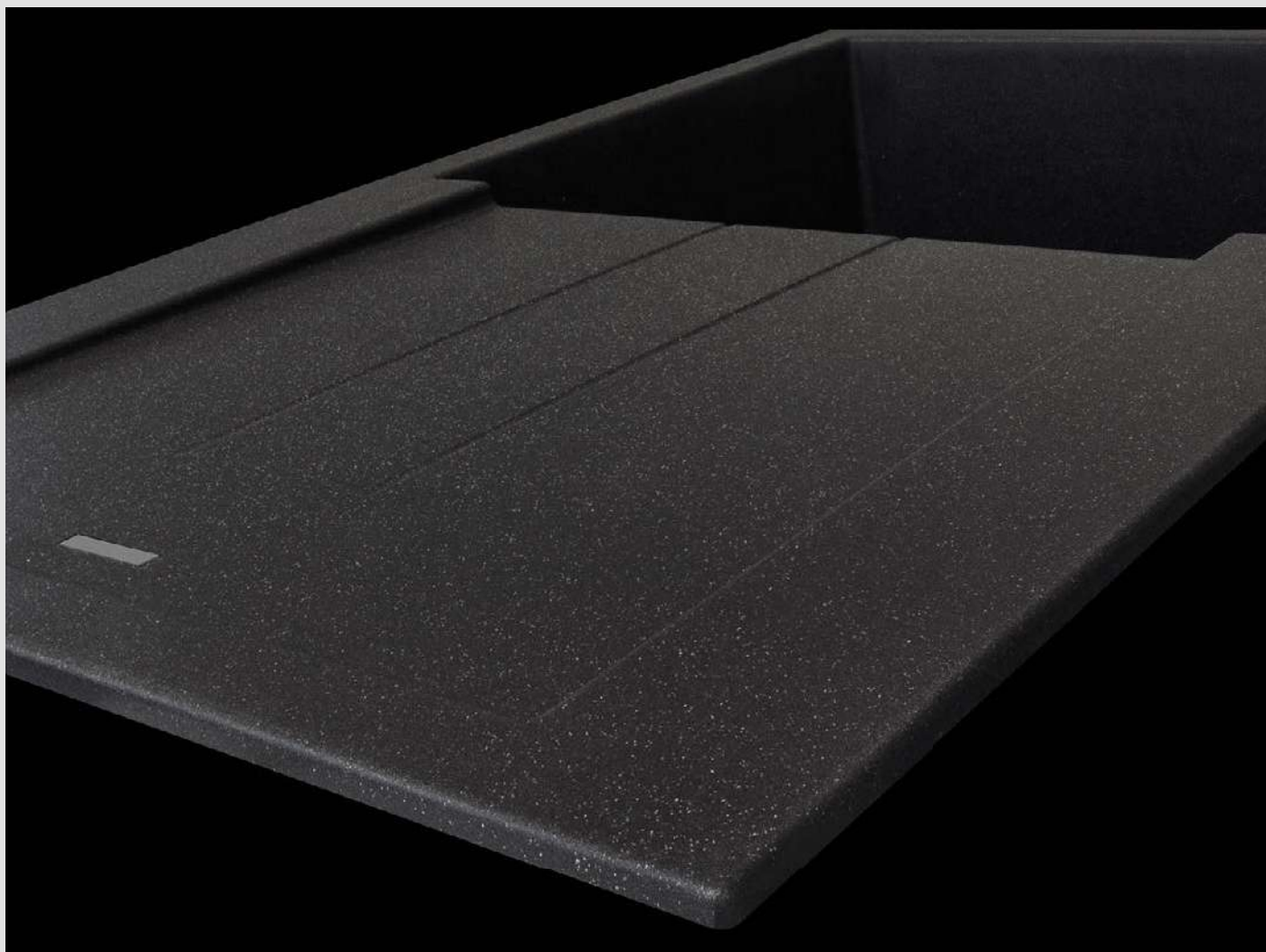

L'altissima concentrazione superficiale (oltre l'80%) di microparticelle di quarzi e graniti generata da un sofisticato processo di sedimentazione in fase di produzione, conferisce al microULTRAGRANIT **straordinarie caratteristiche estetiche ed un piacevole effetto al tatto**, associati ad una elevatissima **durezza superficiale, resistenza** agli agenti chimici, al calore, al graffio.





LAVELLI



SELEZIONE RINNOVA	42
CONTEMPO	54
LUX	60
COSMO	68
ONE Installazione standard	74
ONE Installazione sotto-top	84
ONE Installazione integrata	94
ELEGANCE	100
INFINITY	108
CORAX	114
ATLANTIC	122
SPAZIO	130
HARMONY	138



IL
**LAVELLO
GREEN**
ALL'ORIGINE

RINNOVA

A NEW LEAF

L'ECONOMIA CIRCOLARE GENERA NUOVO VALORE



TRASFORMARE GLI SCARTI IN RISORSE DA RE-IMMETTERE NEL PROCESSO PRODUTTIVO

L'economia circolare è un modello di produzione che si basa sul riutilizzo e il riciclo di materie prime esistenti per generare nuovo valore, contribuendo così sia a ridurre i rifiuti sia ad allungare il ciclo di vita del prodotto. Il livello rinnova ricalca il modello circolare riciclare-produrre-utilizzare a partire da materia prima di recupero pari a più del 90%. Essere green all'origine significa trasformare qualcosa che è già disponibile in risorsa, dando valore agli scarti esterni ed interni di produzione e non andando ad intaccare le risorse naturali non rinnovabili.

COME NASCE UN LAVELLO "RINNOVA"

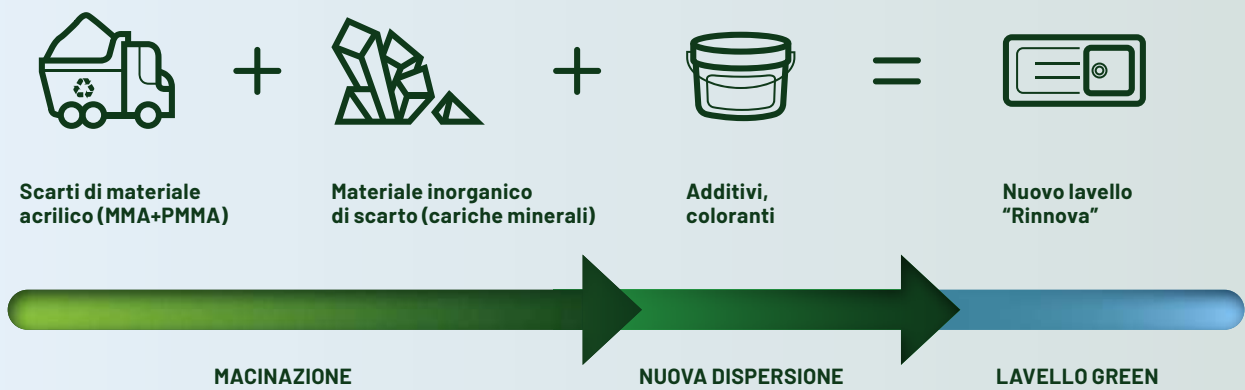

MATERIE PRIME RINNOVATE AL POSTO DI MATERIE PRIME VERGINI

Il nostro obiettivo era massimizzare l'impiego di materie prime organiche (mma+pmma) e inorganiche (cariche minerali) altrimenti destinate alla discarica, così da non ricorrere a materie prime vergini non rinnovabili. Attraverso un processo di rigenerazione delle materie prime di recupero, abbiamo ottenuto un composto green all'origine che garantisce le stesse caratteristiche chimiche, fisiche, meccaniche ed estetiche rispetto al composto tradizionale dei lavelli Plados. La qualità del prodotto finale è identica, la differenza la fa l'origine della materia prima, una differenza capace di essere valore aggiunto.

LE PRESTAZIONI NON CAMBIANO



IL GREEN COME VANTAGGIO QUALITATIVO

La grande sfida del modello sostenibile è riuscire a produrre beni che abbiano un immediato beneficio per l'ambiente senza dover rinunciare agli standard elevati dei requisiti funzionali. Nei lavelli "RINNOVA" l'approccio sostenibile è parte integrante della loro progettazione, delle loro prestazioni e non prescinde mai dalla qualità del prodotto ma è un vantaggio qualitativo: essere green all'origine. I lavelli RINNOVA sono composti da più del 90% di componenti rinnovabili.

CT9010 / CONTEMPO

NEW

Lavello a una vasca
VARIE MISURE - Base da 90 cm

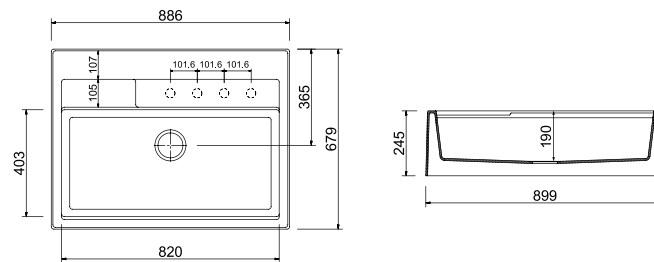

Foro per l'incasso: vedi tabella.

ACCESSORI: 1, 2, 3

RINNOVA

NEW

€ IVA
esclusa

-  RN R1
ARCTIC WHITE
CT9010/... / R1
-  RN R2
DUNE BEIGE
CT9010/... / R2
-  RN R3
ALP STONE
CT9010/... / R3
-  RN R4
VOLCANO BLACK
CT9010/... / R4

1.048

ACCESSORI IN DOTAZIONE:



- Piletta nera con cover e troppopieno neri sulla versione Volcano Black (Cod. KITBLACK1).
- Piletta standard e cover inox sulle altre colorazioni (Cod. COVERIX).

Per la composizione del codice
fare riferimento alla tabella
nella pagina successiva.

ACCESSORI CONSIGLIATI



1_COPHPLX1

2_MULTIRACK

3_VAS700N

TAGLIO DEL BORDO POSTERIORE E DELL'ALTEZZA

Il bordo posteriore del lavello CONTEMPO è sempre battente a muro ed è stato progettato per essere tagliato in modo da adattarsi a piani di lavoro di profondità differenti e per ottenere una sporgenza pari o superiore a 15 mm rispetto al bordo del top. Allo stesso modo sono stati previsti due tagli in altezza, per fare in modo che il sormonto rispetto al piano di lavoro sia pari o superiore a 15 mm nei top spessi da 12 a 20 mm oppure pari o superiore a 5 mm nei top spessi da 30 a 40 mm.

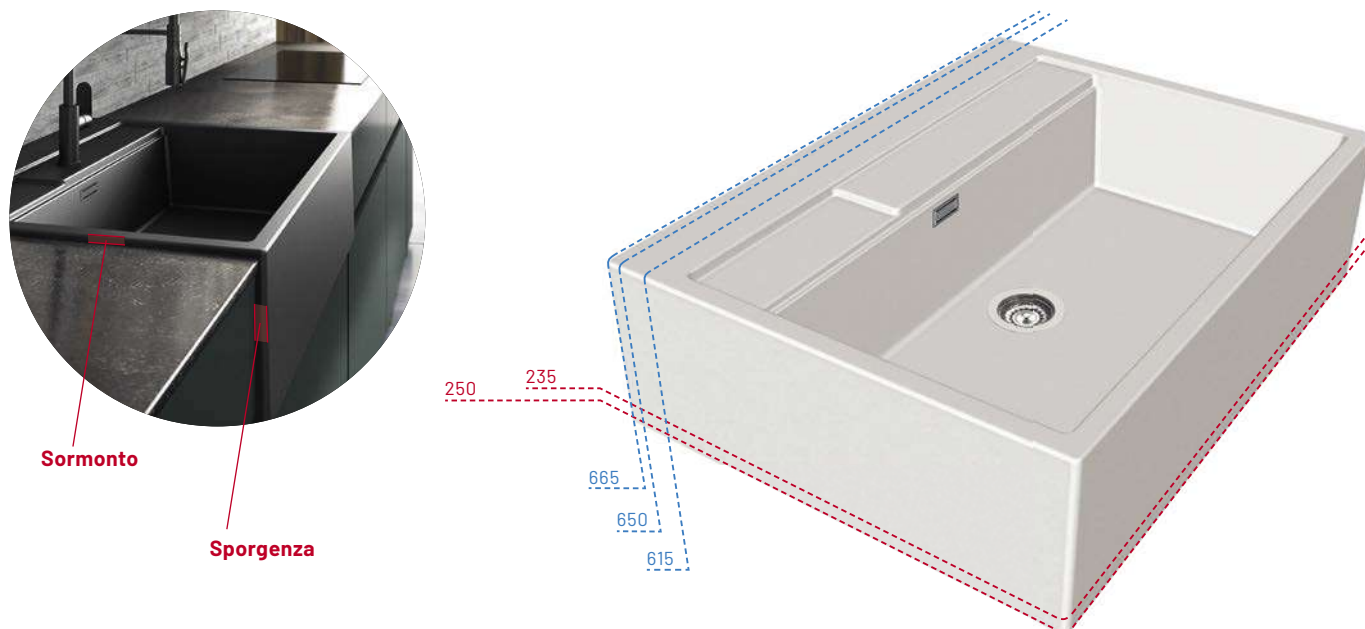

Per ordinare il lavello contempo bisogna indicare **codice prodotto + codice taglio + codice colore**. Scegliere il taglio più adatto, in base alla profondità e allo spessore del piano di lavoro, facendo riferimento ai codici riportati nella seguente tabella; aggiungere infine il codice del colore scelto nella pagina precedente.

	PER TOP PROFONDI 650 mm	PER TOP PROFONDI da 615 mm a 635 mm	PER TOP PROFONDI 600 mm
SPESSORE TOP da 12 mm a 20 mm	Codice: CT9010/23A/... 	Codice: CT9010/23B/... 	Codice: CT9010/23C/...
	SPESSORE TOP da 30 mm a 40 mm	Codice: CT9010/25A/... 	Codice: CT9010/25B/...

LX8610 / LUX



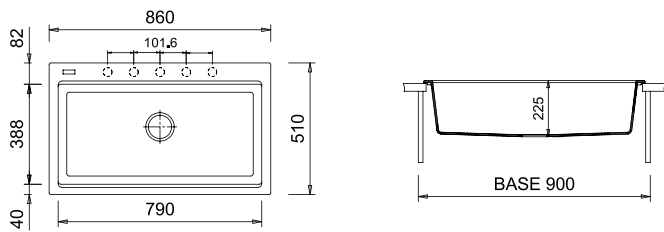

Lavello a una vasca
860x510 mm - Base da 90 cm



Foro per l'incasso: 840x480 mm

ACCESSORI: 1, 3, 4, 5, 6

RINNOVA **NEW** € IVA esclusa

-  RN R1 ARCTIC WHITE
LX8610 / R1
 -  RN R2 DUNE BEIGE
LX8610 / R2
 -  RN R3 ALP STONE
LX8610 / R3
 -  RN R4 VOLCANO BLACK
LX8610 / R4
- 612**

INSTALLAZIONE
SOTTO-TOP

LX8610ST / LUX



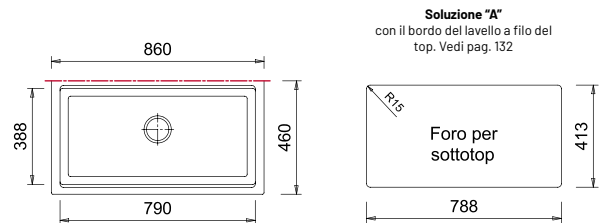

Lavello a una vasca
860x460 mm - Base da 90 cm



Foro per l'incasso: 788x416 mm

ACCESSORI: 1, 3, 4, 5, 6

RINNOVA **NEW** € IVA esclusa

-  RN R1 ARCTIC WHITE
LX8610ST / R1
 -  RN R2 DUNE BEIGE
LX8610ST / R2
 -  RN R3 ALP STONE
LX8610ST / R3
 -  RN R4 VOLCANO BLACK
LX8610ST / R4
- 638**

ACCESSORI CONSIGLIATI



1_COPHPLX2



2_TAGCRLUX



3_LXVASINX



4_VAS70LX



5_SPCESINX



6_ROLLMAT

LX8620 / LUX

Lavello a due vasche
860x510 mm - Base da 90 cm

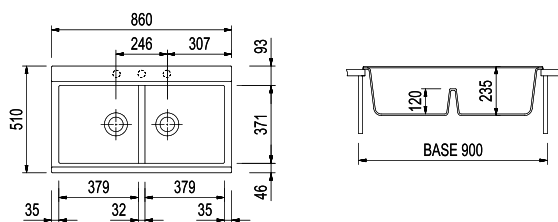

Foro per l'incasso: 840x490 mm

ACCESSORI: 1, 2, 3, 4, 5, 6

RINNOVA

NEW

€ IVA
esclusa

-  RN R1
ARCTIC WHITE
LX8620 / R1
-  RN R2
DUNE BEIGE
LX8620 / R2
-  RN R3
ALP STONE
LX8620 / R3
-  RN R4
VOLCANO BLACK
LX8620 / R4

656

ACCESSORI IN DOTAZIONE:



- Piletta nera con cover e troppopieno neri sulla versione Volcano Black (Cod. KITBLACK1 - KITBLACK2).
- Piletta standard e cover inox sulle altre colorazioni (Cod. COVERIX).

C07510 / COSMO

Lavello a una vasca
756x456 mm - Base da 80 cm

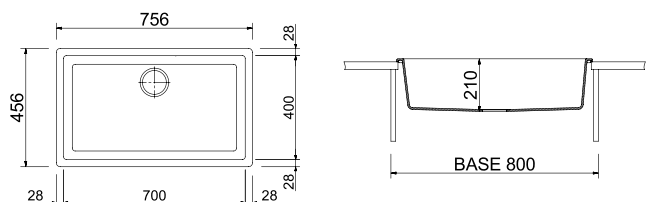

Foro per l'incasso: 745x445 mm



Foro per l'incasso: 700x400 mm

ACCESSORI: 1, 2, 3, 4, 5, 6

RINNOVA

€ IVA esclusa

- RN R1 ARCTIC WHITE
C07510 / R1
- RN R2 DUNE BEIGE
C07510 / R2
- RN R3 ALP STONE
C07510 / R3
- RN R4 VOLCANO BLACK
C07510 / R4

602

DISPONIBILE DAL 2025

C05510 / COSMO

Lavello a una vasca
556x456 mm - Base da 60 cm

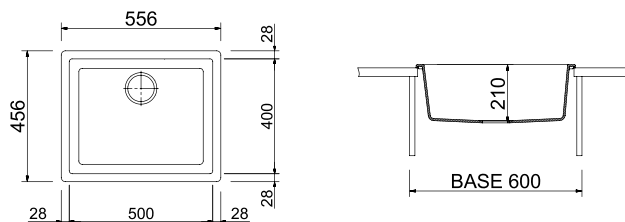

Foro per l'incasso: 545x445 mm



Foro per l'incasso: 500x400 mm

ACCESSORI: 1, 2, 3, 4, 5, 6

RINNOVA

€ IVA esclusa

- RN R1 ARCTIC WHITE
C05510 / R1
- RN R2 DUNE BEIGE
C05510 / R2
- RN R3 ALP STONE
C05510 / R3
- RN R4 VOLCANO BLACK
C05510 / R4

548

DISPONIBILE DAL 2025

ACCESSORI CONSIGLIATI



1_COPHPLON



2_TAGL44



3_ONTAGCR



4_SPESINX



5_ROLLUP



6_ROLLMAT

C04510 / COSMO

Lavello a una vasca
456x456 mm - Base da 45/50 cm

NEW

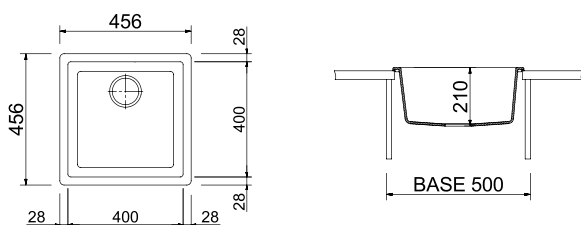

INSTALLAZIONE
STANDARD

Foro per l'incasso: 445x445 mm



INSTALLAZIONE
SOTTO-TOP

Foro per l'incasso: 400x400 mm

ACCESSORI: 1, 2, 3, 4, 5, 6

RINNOVA **NEW**

€ IVA
esclusa

-  RN R1
ARCTIC WHITE
C04510 / R1
-  RN R2
DUNE BEIGE
C04510 / R2
-  RN R3
ALP STONE
C04510 / R3
-  RN R4
VOLCANO BLACK
C04510 / R4

492

DISPONIBILE DAL 2025

ACCESSORI IN DOTAZIONE:



• Piletta nera con cover e troppopieno neri sulla versione Volcano Black (Cod. KITBLACK1).

• Piletta standard e cover inox sulle altre colorazioni (Cod. COVERIX).

Nei lavelli COSMO è inclusa sia la ferramenta per l'installazione standard che quella per il montaggio sotto top.

NF11620 / INFINITY

Lavello a due vasche più scolapiatti - Reversibile
1160x500 mm - Base da 80 cm

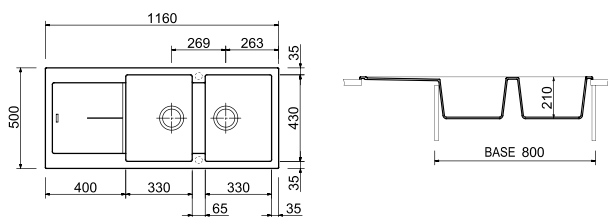
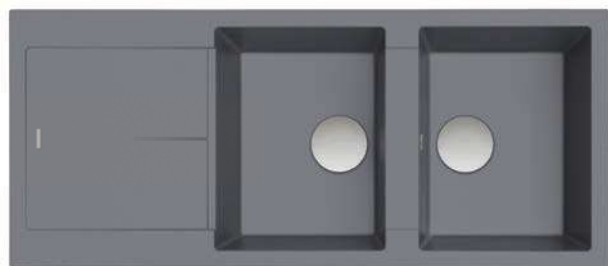

Foro per l'incasso: 1140x480 mm

ACCESSORI: 1, 2, 3, 4, 5, 6

RINNOVA **NEW** € IVA esclusa

-  RN R1 ARCTIC WHITE
NF11620 / R1
-  RN R2 DUNE BEIGE
NF11620 / R2
-  RN R3 ALP STONE
NF11620 / R3
-  RN R4 VOLCANO BLACK
NF11620 / R4

584

NF9910 / INFINITY

Lavello a una vasca più scolapiatti - Reversibile
990x500 mm - Base da 60 cm

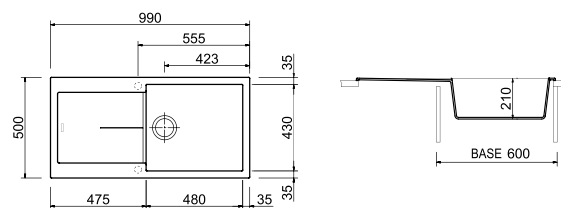
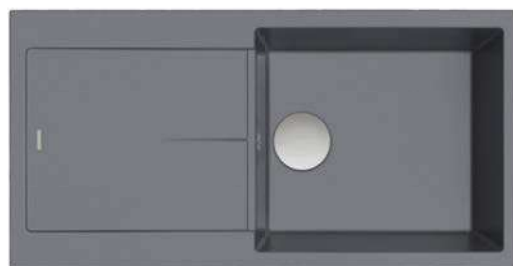

Foro per l'incasso: 970x480 mm

ACCESSORI: 1, 2, 3, 4, 5, 6

RINNOVA **NEW** € IVA esclusa

-  RN R1 ARCTIC WHITE
NF9910 / R1
-  RN R2 DUNE BEIGE
NF9910 / R2
-  RN R3 ALP STONE
NF9910 / R3
-  RN R4 VOLCANO BLACK
NF9910 / R4

574

ACCESSORI CONSIGLIATI



1_TAGL88



2_TAGP66



3_TAGCR



4_SPCESINX



5_ROLLUP



6_ROLLMAT

NF8610 / INFINITY

Lavello a una vasca più scolapiatti - Reversibile
860x500 mm - Base da 60 cm

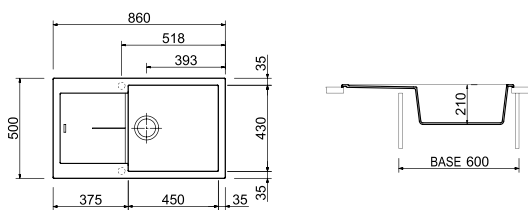
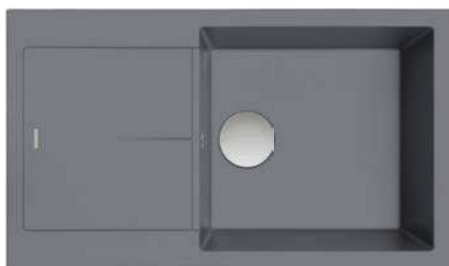

Foro per l'incasso: 840x480 mm

ACCESSORI: 1, 2, 3, 4, 5, 6

ACCESSORI IN DOTAZIONE:



• Piletta nera con cover e troppopieno neri sulla versione Volcano Black (Cod. KITBLACK1 - KITBLACK2).

• Piletta standard e cover inox sulle altre colorazioni (Cod. COVERIX).

RINNOVA



€ IVA esclusa



RN R1
ARCTIC WHITE
NF08610 / R1



RN R2
DUNE BEIGE
NF08610 / R2



RN R3
ALP STONE
NF08610 / R3



RN R4
VOLCANO BLACK
NF08610 / R4

538



LAVELLI

CONTEMPO

Un tempo nelle case rurali, il lavabo era il centro di molte operazioni che andavano dalla preparazione dei cibi, al lavaggio di pentole, vestiti e persino bambini. Contempo è la nostra reinterpretazione dell'antico lavabo, con un design rinnovato che attraversando epoche e stili si adatta ad ogni ambientazione, country o moderna. Il banco rubinetteria è ampio e spazioso per ospitare accessori e utensili. Le guide ai bordi della vasca sono progettate per accogliere accessori scorrevoli che rendono l'esperienza d'uso più pratica e funzionale.



ARIAPURA



ITALIAN
TECHNOLOGY



100% ECO
COMPATIBILE



FINITURE



PLUS



ARIA PURA



ITALIAN
TECHNOLOGY



100% ECO
COMPATIBILE

CORREDO

- Piletta
- Sifone

INSTALLAZIONE

- Semi-incasso

CONTEMPO

CARATTERISTICHE DI PRODOTTO

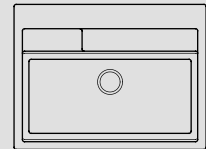

CT9010



COUNTRY CONTEMPORANEO

Un design senza tempo unisce il fascino del passato alla tecnologia dei più moderni materiali compositi.

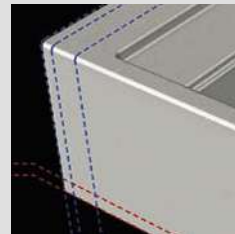

DIMENSIONI SEMPRE AD HOC

Il lavello è progettato per essere tagliato in modo da adattarsi a diverse esigenze di altezza e profondità.



ACCESSORI SCORREVOLI

Belli, utili e pratici, gli accessori scorrevoli migliorano l'esperienza d'uso e la vita di ogni giorno.

MISCELATORI CONSIGLIATI



SHOWERMID
pag. 192



MIG10
pag. 198

REALTÀ AUMENTATA



Inquadra il qr-code con il tuo smartphone per scoprire i nostri lavelli in realtà aumentata.

CT9010 / CONTEMPO

NEW

Lavello a una vasca
VARIE MISURE - Base da 90 cm

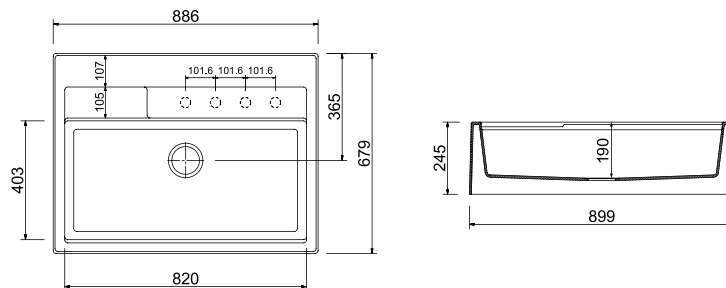

Foro per l'incasso: vedi tabella.

ACCESSORI: 1, 2, 3

NANOSTONE

€ IVA
esclusa

-  NS N1
BIANCO LATTE
CT9010/... / N1
-  NS N3
ARGAN
CT9010/... / N3
-  NS N4
URBAN GREY
CT9010/... / N4
-  NS N6
DEEP BLACK
CT9010/... / N6



914

Per la composizione del codice
fare riferimento alla tabella
nella pagina successiva.

ACCESSORI CONSIGLIATI



1_C0PHPLX1



2_MULTIRACK



3_VAS700N

TAGLIO DEL BORDO POSTERIORE E DELL'ALTEZZA

Il bordo posteriore del lavello CONTEMPO è sempre battente a muro ed è stato progettato per essere tagliato in modo da adattarsi a piani di lavoro di profondità differenti e per ottenere una sporgenza pari o superiore a 15 mm rispetto al bordo del top. Allo stesso modo sono stati previsti due tagli in altezza, per fare in modo che il sormonto rispetto al piano di lavoro sia pari o superiore a 15 mm nei top spessi da 12 a 20 mm oppure pari o superiore a 5 mm nei top spessi da 30 a 40 mm.

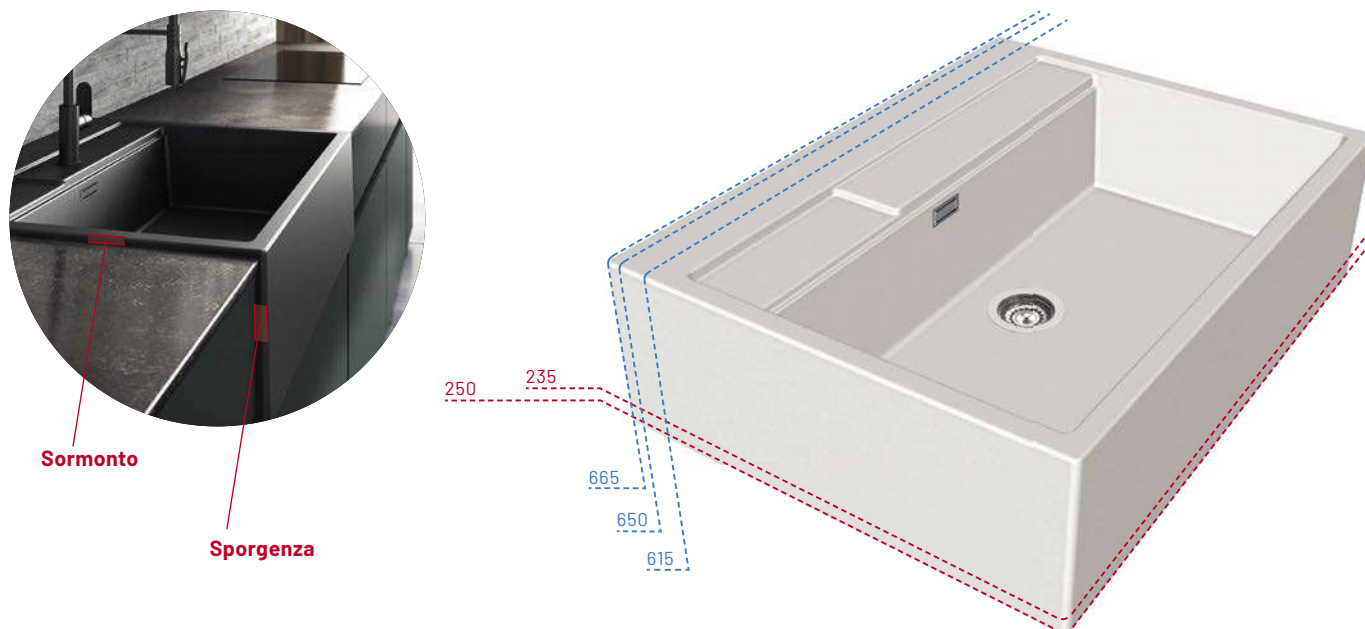

Per ordinare il lavello contempo bisogna indicare **codice prodotto + codice taglio + codice colore**. Scegliere il taglio più adatto, in base alla profondità e allo spessore del piano di lavoro, facendo riferimento ai codici riportati nella seguente tabella; aggiungere infine il codice del colore scelto nella pagina precedente.

	PER TOP PROFONDI 650 mm	PER TOP PROFONDI da 615 mm a 635 mm	PER TOP PROFONDI 600 mm
SPESSORE TOP da 12 mm a 20 mm	Codice: CT9010/23A/... 	Codice: CT9010/23B/... 	Codice: CT9010/23C/...
	SPESSORE TOP da 30 mm a 40 mm	Codice: CT9010/25A/... 	Codice: CT9010/25B/...





LAVELLI



LUX

I modelli della serie LUX sono provvisti di guide su cui posizionare accessori scorrevoli progettati ad hoc: vaschette in acciaio inossidabile, taglieri in cristallo temperato, copri-vasca in HPL e molto altro ancora. Gli accessori di ultima generazione sono disponibili in diverse finiture per potersi abbinare al meglio all'ambiente cucina e rendere il lavello non solo più pratico e funzionale ma anche più elegante.

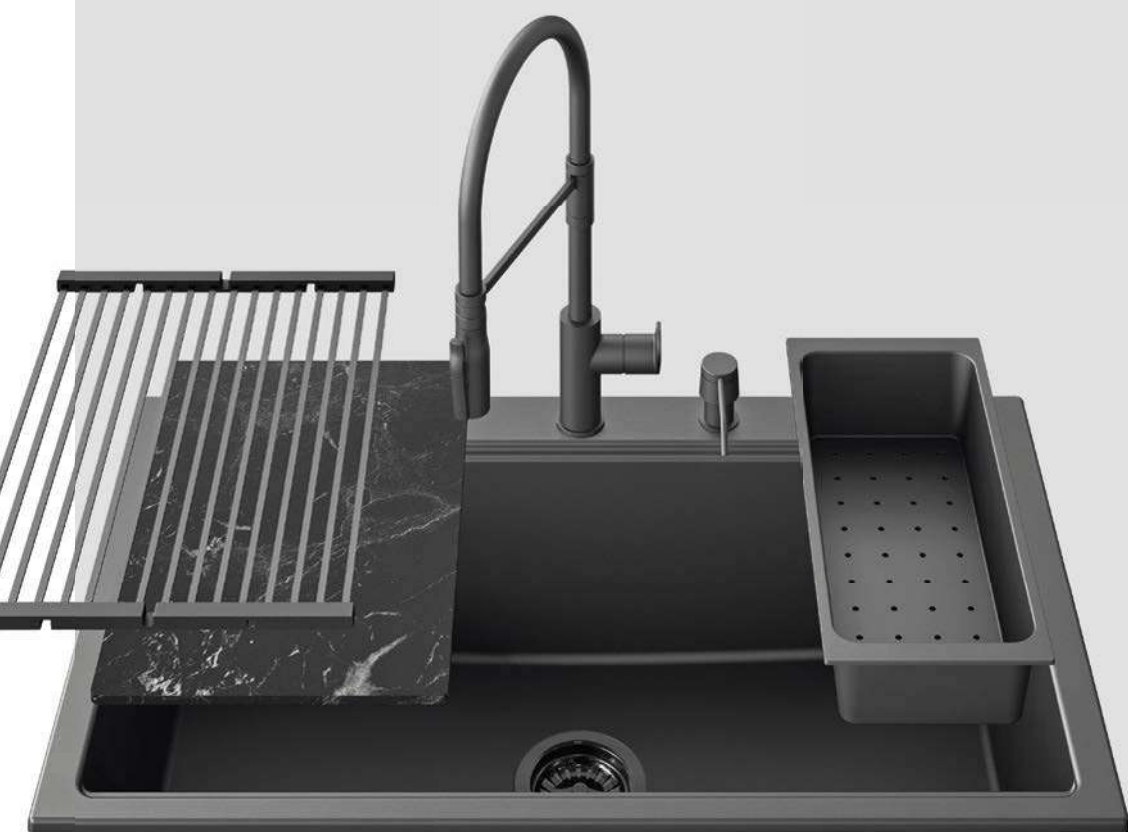

FINITURE



PLUS



ARIA PURA



ITALIAN
TECHNOLOGY



100% ECO
COMPATIBILE

CORREDO

- Piletta
- Sifone
- Ganci

INSTALLAZIONE

- Standard

LUX

CARATTERISTICHE DI PRODOTTO

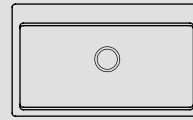

LX8610

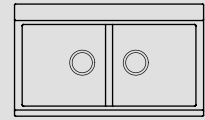

LX8620



LAVELLI MULTIACCESSORIATI

I modelli della serie LUX sono provvisti di guide su cui posizionare accessori scorrevoli progettati ad hoc, tra cui degli eleganti taglieri in vetro o in HPL ed una comodissima vaschetta in acciaio inox.



TROPPOPIENO RETTANGOLARE

Nei modelli LX8610, LX8620, è incluso il troppopieno rettangolare di design, con la possibilità di avere numerosi optional come i nuovi copri-piletta o i kit PVD in diverse finiture.



MAXI VASCHE

Le maxi vasche dei lavelli LUX, praticissime grazie alle grandi dimensioni, sono una soluzione ideale per una cucina spaziosa e per le famiglie numerose.

MISCELATORI CONSIGLIATI



HEGO
pag. 192



NEWMIX30
pag. 198

REALTÀ AUMENTATA



Inquadra il qr-code con il tuo smartphone per scoprire i nostri lavelli in realtà aumentata.

LX8610 / LUX

Lavello a una vasca
860x510 mm - Base da 90 cm

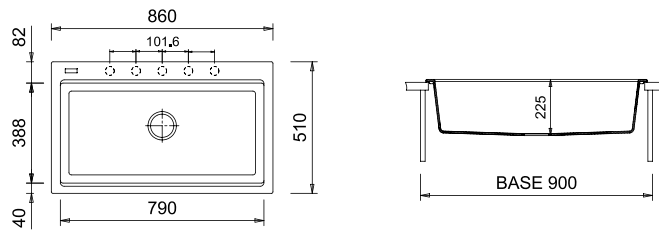





Foro per l'incasso: 840x480 mm

ACCESSORI: 1, 2, 3, 4, 5





MICROULTRAGRANIT

€ IVA esclusa

-  UG 70
NERO MATT
LX8610 / 70 
-  UG 72
TARTUFO
LX8610 / 72 **414**
-  UG 98
BIANCO
LX8610 / 98





NANOSTONE

€ IVA esclusa

-  NS N1
BIANCO LATTE
LX8610 / N1 
-  NS N3
ARGAN
LX8610 / N3 **514**
-  NS N4
URBAN GREY
LX8610 / N4
-  NS N6
DEEP BLACK
LX8610 / N6

ULTRAMETAL

€ IVA esclusa

-  UM 41
ALLUMINIO
LX8610 / 41 
-  UM 42
TITANIO
LX8610 / 42 **442**
-  UM 14
CONCRETE
LX8610 / 14
-  UM 44
NERO
LX8610 / 44

ACCESSORI CONSIGLIATI



1_COPHPLX2 2_LXVASINX 3_VAS70LX 4_SPCESINX 5_ROLLMAT



LX8620 / LUX

Lavello a due vasche
860x510 mm - Base da 90 cm

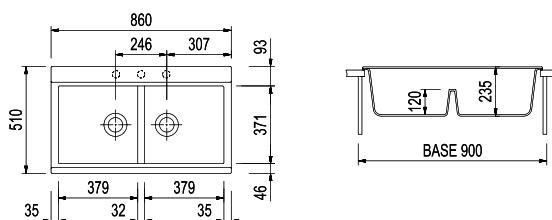





Foro per l'incasso: 840x490 mm

ACCESSORI: 1, 2, 3, 4, 5, 6





MICROULTRAGRANIT

€ IVA esclusa

	UG 70 NERO MATT LX8620 / 70	
	UG 72 TARTUFO LX8620 / 72	458
	UG 98 BIANCO LX8620 / 98	





NANOSTONE

€ IVA esclusa

	NS N1 BIANCO LATTE LX8620 / N1	
	NS N3 ARGAN LX8620 / N3	556
	NS N4 URBAN GREY LX8620 / N4	
	NS N6 DEEP BLACK LX8620 / N6	

ULTRAMETAL

€ IVA esclusa

	UM 41 ALLUMINIO LX8620 / 41	
	UM 42 TITANIO LX8620 / 42	482
	UM 14 CONCRETE LX8620 / 14	
	UM 44 NERO LX8620 / 44	

ACCESSORI CONSIGLIATI



1_COPHPLX2 2_TAGCRLUX 3_LXVASINX 4_VAS70LX 5_SPCESINX 6_ROLLMAT



Coprivasca in HPL - **COPHPLX2**

- COPHPLX2/TOR** - Tortora
- COPHPLX2/CEM** - Cemento
- COPHPLX2/ARD** - Ardesia

Il codice si riferisce a un singolo coprivasca e non alla coppia.



Taglieri in cristallo temperato - **TAGCRLUX**

- Cod. **TAGCRLUX/K1** - Bianco
- Cod. **TAGCRLUX/K2** - Nero

Il codice si riferisce a un singolo tagliere e non alla coppia.



Copri troppopieno
TPPE10P



Copri-piletta di scarico
COPPILT10



Vaschetta in polycarbonato
VAS70LX



Vaschetta in acciaio inox
LXVASINX





LAVELLI



COSMO

Crediamo che la bellezza e la funzionalità siano strettamente legate alla semplicità: Kosmos in greco significa ordine e i lavelli COSMO, con la loro estetica priva di ogni sofisticazione ma al contempo altamente funzionale, incarnano bellezza e semplicità. L'installazione può essere di tipo standard o sotto-top e la ferramenta è inclusa per entrambe.



ARIAPURA



ITALIAN
TECHNOLOGY



100% ECO
COMPATIBILE



FINITURE



PLUS



ARIA PURA



ITALIAN
TECHNOLOGY



100% ECO
COMPATIBILE

CORREDO

- Piletta
- Sifone

INSTALLAZIONE

- Standard
- Sotto-top

COSMO

CARATTERISTICHE DI PRODOTTO

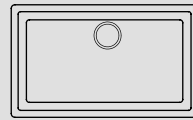

C07510

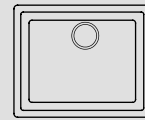

C05510

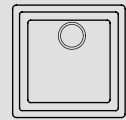

C04510



ESSENZIALE

Uno stile lineare adatto ad ogni ambiente, dal country al contemporaneo.



TROPPOPIENO RETTANGOLARE

Nei modelli della serie COSMO il troppopieno rettangolare di design è incluso.



FERRAMENTA INCLUSA

Nei lavelli della serie COSMO è inclusa sia la ferramenta per l'installazione standard che quella per l'installazione sotto-top.

MISCELATORI CONSIGLIATI



SPRINGP30
pag. 194



HYDRA
pag. 206

REALTÀ AUMENTATA



Inquadra il qr-code con il tuo smartphone per scoprire i nostri lavelli in realtà aumentata.

C07510 / COSMO



Lavello a una vasca
756x456 mm - Base da 80 cm

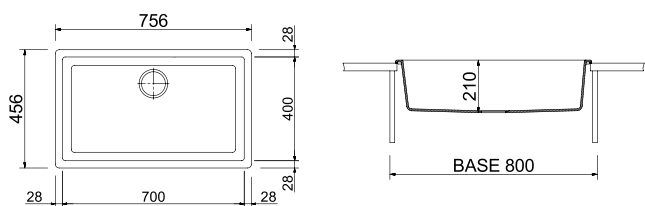

Foro per l'incasso: 745x445 mm



Foro per l'incasso: 700x400 mm

ACCESSORI: 1, 2, 3, 4, 5, 6

NANOSTONE

€ IVA esclusa



NS N1
BIANCO LATTE
C07510 / N1



NS N3
ARGAN
C07510 / N3



NS N4
URBAN GREY
C07510 / N4



NS N6
DEEP BLACK
C07510 / N6

556

DISPONIBILE DAL 2025

C05510 / COSMO



Lavello a una vasca
556x456 mm - Base da 60 cm

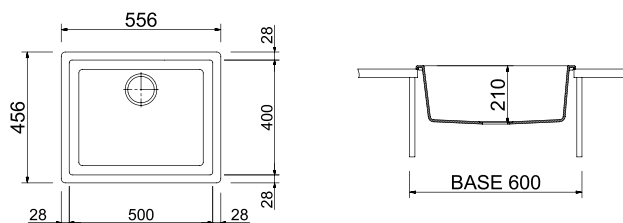

Foro per l'incasso: 545x445 mm



Foro per l'incasso: 500x400 mm

ACCESSORI: 1, 2, 3, 4, 5, 6

NANOSTONE

€ IVA esclusa



NS N1
BIANCO LATTE
C05510 / N1



NS N3
ARGAN
C05510 / N3



NS N4
URBAN GREY
C05510 / N4



NS N6
DEEP BLACK
C05510 / N6

502

DISPONIBILE DAL 2025

ACCESSORI CONSIGLIATI



1_C0PHPLON



2_TAGL44



3_ONTAGCR



4_SPCESINX



5_ROLLUP



6_ROLLMAT

C04510 / COSMO

Lavello a una vasca
456x456 mm - Base da 45/50 cm

NEW

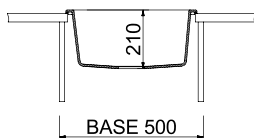
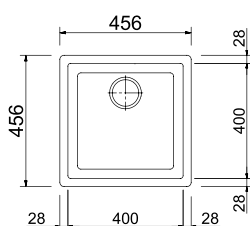

INSTALLAZIONE
STANDARD

Foro per l'incasso: 445x445 mm



INSTALLAZIONE
SOTTO-TOP

Foro per l'incasso: 400x400 mm

ACCESSORI: 1, 2, 3, 4, 5, 6

NANOSTONE

€ IVA
esclusa

NS N1
BIANCO LATTE
C04510 / N1

NS N3
ARGAN
C04510 / N3

NS N4
URBAN GREY
C04510 / N4

NS N6
DEEP BLACK
C04510 / N6

448

DISPONIBILE DAL 2025

Nei lavelli COSMO è inclusa sia la ferramenta per l'installazione standard che quella per il montaggio sotto top.

LAVELLI



ONE



INSTALLAZIONE
STANDARD

ONE, dal design moderno e funzionale si sposa perfettamente con le cucine minimaliste e di tendenza. La serie ONE è divisa a seconda del metodo di installazione:

- Installazione STANDARD pag. 78-82
- Installazione SOTTO-TOP pag. 88-92
- Installazione INTEGRATA pag. 98







FINITURE



PLUS



ARIA PURA



ITALIAN
TECHNOLOGY



100% ECO
COMPATIBILE

CORREDO

- Piletta
- Sifone
- Ganci

INSTALLAZIONE

- **Standard**
- Sotto-top (pag. 88-92)
- Integrata (pag. 98)

ONE - installazione standard
**CARATTERISTICHE
 DI PRODOTTO**

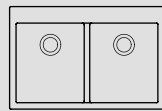

ON8420

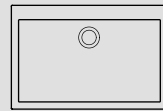

ON8410

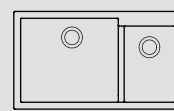

ON8620

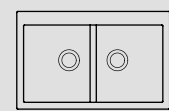

ON7920



ON7610



ON6910

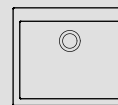

ON6010

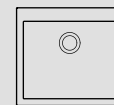

ON5610

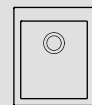

ON4110



**DESIGN
 MINIMAL**

La serie One, grazie al suo design moderno e funzionale, e ai raggi interni molto stretti, si sposa perfettamente con le cucine minimaliste e di tendenza.



**LAVELLI
 MULTIACCESSORIATI**

Accessori di ogni tipologia a corredo della serie ONE: taglieri, vaschette in policarbonato, cestelli, copri-piletta creano una vera e propria stazione di lavoro in cucina.



**GAMMA
 COLORI**

La linea ONE è disponibile in tutti i colori ed in tutte e 3 le nostre finiture.

MISCELATORI CONSIGLIATI



NEMO
 pag. 202



COLONNA
 pag. 204

REALTÀ AUMENTATA



Inquadra il qr-code con il tuo smartphone per scoprire i nostri lavelli in realtà aumentata.



ON8420 / ONE

Lavello a due vasche
840x559 mm - Base da 90 cm

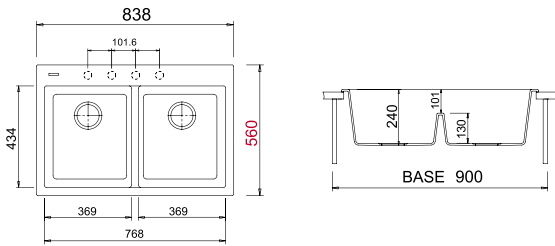



Foro per l'incasso: 820x540 mm
ATTENZIONE: Lavello profondo 56 cm

ACCESSORI: 7

MICROULTRAGRANIT



€ IVA esclusa

-  UG 70 NERO MATT
ON8420 / 70
-  UG 72 TARTUFO
ON8420 / 72
-  UG 98 BIANCO
ON8420 / 98

530

ULTRAMETAL

€ IVA esclusa

-  UM 41 ALLUMINIO
ON8420 / 41
-  UM 42 TITANIO
ON8420 / 42
-  UM 44 NERO
ON8420 / 44

556



INSTALLAZIONE STANDARD

ON8410 / ONE

Lavello a una vasca
840x559 mm - Base da 90 cm

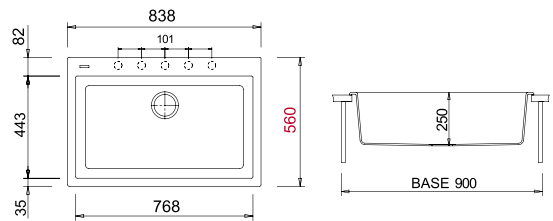



Foro per l'incasso: 820x540 mm
ATTENZIONE: Lavello profondo 56 cm

ACCESSORI: 7, 12

MICROULTRAGRANIT



€ IVA esclusa

-  UG 70 NERO MATT
ON8410 / 70
-  UG 72 TARTUFO
ON8410 / 72
-  UG 98 BIANCO
ON8410 / 98

492

ULTRAMETAL

€ IVA esclusa

-  UM 41 ALLUMINIO
ON8410 / 41
-  UM 42 TITANIO
ON8410 / 42
-  UM 44 NERO
ON8410 / 44

520

ACCESSORI CONSIGLIATI



1_COPHLON



2_TAGL44



3_TAGL88



4_TAGP66



5_TAGCR



6_ONTAGCR



7_SPCESINX



ON8620 / ONE

Lavello a due vasche
860x500 mm - Base da 90 cm

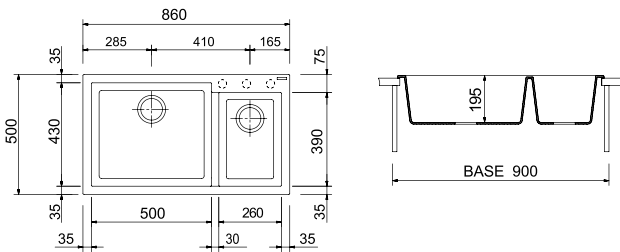

Foro per l'incasso: 840x480 mm

ACCESSORI: 3, 4, 5, 7, 8, 9

MICROULTRAGRANIT

€ IVA esclusa

- UG 56 JASMINE ON8620 / 56
- UG 70 NERO MATT ON8620 / 70
- UG 72 TARTUFO ON8620 / 72
- UG 90 BIANCO OPALE ON8620 / 90
- UG 94 AVENA ON8620 / 94
- UG 95 NERO EBONY ON8620 / 95
- UG 98 BIANCO ON8620 / 98

484

ULTRAMETAL

€ IVA esclusa

- UM 41 ALLUMINIO ON8620 / 41
- UM 42 TITANIO ON8620 / 42
- UM 14 CONCRETE ON8620 / 14
- UM 44 NERO ON8620 / 44

510

NANOSTONE

€ IVA esclusa

- NS N1 BIANCO LATTE ON8620 / N1
- NS N3 ARGAN ON8620 / N3
- NS N4 URBAN GREY ON8620 / N4
- NS N6 DEEP BLACK ON8620 / N6

592



ON7920 / ONE

Lavello a due vasche
790x500 mm - Base da 80 cm

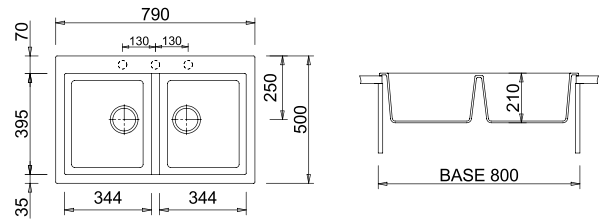

Foro per l'incasso: 770x480 mm

ACCESSORI: 1, 2, 3, 4, 6, 7, 8, 9, 10, 11

MICROULTRAGRANIT

€ IVA esclusa

- UG 56 JASMINE ON7920 / 56
- UG 70 NERO MATT ON7920 / 70
- UG 72 TARTUFO ON7920 / 72
- UG 90 BIANCO OPALE ON7920 / 90
- UG 94 AVENA ON7920 / 94
- UG 95 NERO EBONY ON7920 / 95
- UG 98 BIANCO ON7920 / 98

394

ULTRAMETAL

€ IVA esclusa

- UM 41 ALLUMINIO ON7920 / 41
- UM 42 TITANIO ON7920 / 42
- UM 14 CONCRETE ON7920 / 14
- UM 44 NERO ON7920 / 44

418

NANOSTONE

€ IVA esclusa

- NS N1 BIANCO LATTE ON7920 / N1
- NS N3 ARGAN ON7920 / N3
- NS N4 URBAN GREY ON7920 / N4
- NS N6 DEEP BLACK ON7920 / N6

488



8_ROLLUP



9_ROLLMAT



10_ONVASINX



11_ONVASINX

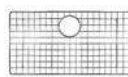

12_GRID84

ON7610 / ONE

Lavello a una vasca
760x500 mm - Base da 80 cm

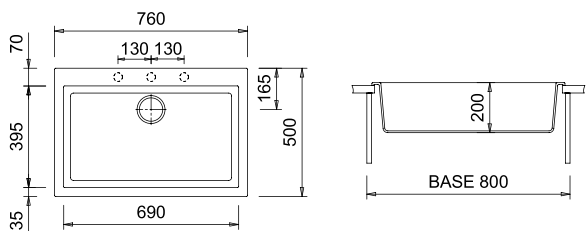

Foro per l'incasso: 740x480 mm

ACCESSORI: 1, 2, 3, 4, 5, 6, 7, 8, 9, 10, 11

ON6910 / ONE

Lavello a una vasca
690x500 mm - Base da 75 cm

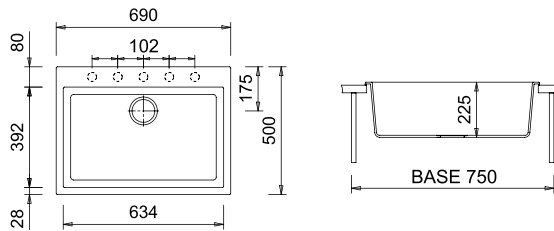

Foro per l'incasso: 680x490 mm

ACCESSORI: 1, 2, 3, 4, 5, 6, 7, 8, 9, 10

MICROULTRAGRANIT

€ IVA esclusa

UG 56
JASMINE
ON7610 / 56

UG 70
NERO MATT
ON7610 / 70

UG 72
TARTUFO
ON7610 / 72

UG 90
BIANCO OPALE
ON7610 / 90

UG 94
AVENA
ON7610 / 94

UG 95
NERO EBONY
ON7610 / 95

UG 98
BIANCO
ON7610 / 98

376

ULTRAMETAL

€ IVA esclusa

UM 41
ALLUMINIO
ON7610 / 41

UM 42
TITANIO
ON7610 / 42

UM 14
CONCRETE
ON7610 / 14

UM 44
NERO
ON7610 / 44



400

NANOSTONE

€ IVA esclusa

NS N1
BIANCO LATTE
ON7610 / N1

NS N3
ARGAN
ON7610 / N3

NS N4
URBAN GREY
ON7610 / N4

NS N6
DEEP BLACK
ON7610 / N6



476

MICROULTRAGRANIT

€ IVA esclusa

UG 56
JASMINE
ON6910 / 56

UG 70
NERO MATT
ON6910 / 70

UG 72
TARTUFO
ON6910 / 72

UG 90
BIANCO OPALE
ON6910 / 90

UG 94
AVENA
ON6910 / 94

UG 95
NERO EBONY
ON6910 / 95

UG 98
BIANCO
ON6910 / 98

402

ULTRAMETAL

€ IVA esclusa

UM 41
ALLUMINIO
ON6910 / 41

UM 42
TITANIO
ON6910 / 42

UM 14
CONCRETE
ON6910 / 14

UM 44
NERO
ON6910 / 44

428

NANOSTONE

€ IVA esclusa

NS N1
BIANCO LATTE
ON6910 / N1

NS N3
ARGAN
ON6910 / N3

NS N4
URBAN GREY
ON6910 / N4

NS N6
DEEP BLACK
ON6910 / N6

510

ACCESSORI CONSIGLIATI



1_COPHLON



2_TAGL44



3_TAGL88



4_TAGP66



5_ONTAGCR



6_SPESINX



7_ROLLUP



8_ROLLMAT

ON6010 / ONE

Lavello a una vasca
600x510 mm - Base da 60-80 cm

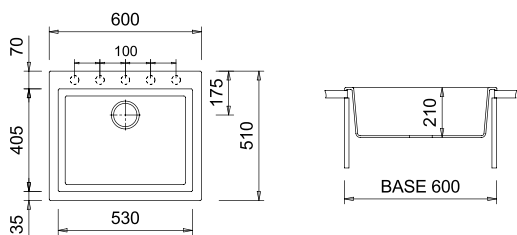



Foro per l'incasso: 580x480 mm

ACCESSORI: 1, 2, 3, 4, 5, 6, 7, 8, 9, 10, 12

MICROULTRAGRANIT

€ IVA
esclusa





-  UG 56
JASMINE
ON6010 / 56
-  UG 70
NERO MATT
ON6010 / 70
-  UG 72
TARTUFO
ON6010 / 72
-  UG 90
BIANCO OPALE
ON6010 / 90
-  UG 94
AVENA
ON6010 / 94
-  UG 95
NERO EBONY
ON6010 / 95
-  UG 98
BIANCO
ON6010 / 98



348

ULTRAMETAL

€ IVA
esclusa

-  UM 41
ALLUMINIO
ON6010 / 41
-  UM 42
TITANIO
ON6010 / 42
-  UM 14
CONCRETE
ON6010 / 14
-  UM 44
NERO
ON6010 / 44



376

NANOSTONE

€ IVA
esclusa

-  NS N1
BIANCO LATTE
ON6010 / N1
-  NS N3
ARGAN
ON6010 / N3
-  NS N4
URBAN GREY
ON6010 / N4
-  NS N6
DEEP BLACK
ON6010 / N6



448

ON5610 / ONE

Lavello a una vasca
560x500 mm - Base da 60 cm

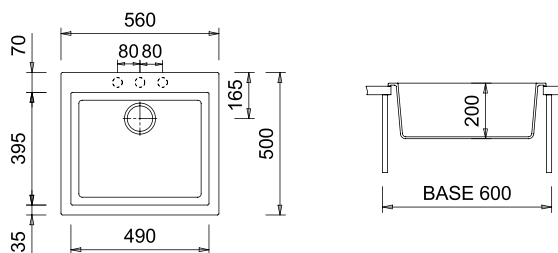



Foro per l'incasso: 540x480 mm

ACCESSORI: 1, 2, 3, 4, 5, 6, 7, 8, 9, 10, 12

MICROULTRAGRANIT

€ IVA
esclusa

-  UG 56
JASMINE
ON5610 / 56
-  UG 70
NERO MATT
ON5610 / 70
-  UG 72
TARTUFO
ON5610 / 72
-  UG 90
BIANCO OPALE
ON5610 / 90
-  UG 94
AVENA
ON5610 / 94
-  UG 95
NERO EBONY
ON5610 / 95
-  UG 98
BIANCO
ON5610 / 98



348

ULTRAMETAL

€ IVA
esclusa

-  UM 41
ALLUMINIO
ON5610 / 41
-  UM 42
TITANIO
ON5610 / 42
-  UM 14
CONCRETE
ON5610 / 14
-  UM 44
NERO
ON5610 / 44



376

NANOSTONE

€ IVA
esclusa

-  NS N1
BIANCO LATTE
ON5610 / N1
-  NS N3
ARGAN
ON5610 / N3
-  NS N4
URBAN GREY
ON5610 / N4
-  NS N6
DEEP BLACK
ON5610 / N6



448



9_ONVASINX



10_ONVASINX

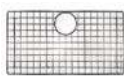

11_GRID76



12_GRID60

ON4110 / ONE

Lavello a una vasca
410x500 mm - Base da 45 cm

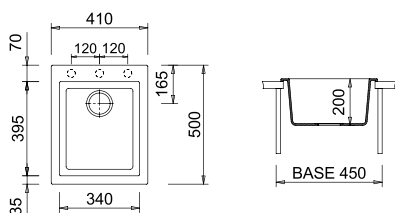

Foro per l'incasso: 390x480 mm

ACCESSORI: 1, 2, 3, 4, 5, 6, 7, 8

MICROULTRAGRANIT

€ IVA esclusa

UG 56
JASMINE
ON4110 / 56

UG 70
NERO MATT
ON4110 / 70

UG 72
TARTUFO
ON4110 / 72

UG 90
BIANCO OPALE
ON4110 / 90

UG 94
AVENA
ON4110 / 94

UG 95
NERO EBONY
ON4110 / 95

UG 98
BIANCO
ON4110 / 98



300

ULTRAMETAL

€ IVA esclusa

UM 41
ALLUMINIO
ON4110 / 41

UM 42
TITANIO
ON4110 / 42

UM 14
CONCRETE
ON4110 / 14

UM 44
NERO
ON4110 / 44



324

NANOSTONE

€ IVA esclusa

NS N1
BIANCO LATTE
ON4110 / N1

NS N3
ARGAN
ON4110 / N3

NS N4
URBAN GREY
ON4110 / N4

NS N6
DEEP BLACK
ON4110 / N6



400

ACCESSORI CONSIGLIATI



1_COPHPLON



2_TAGL44



3_ONTAGCR



4_SPCESINX



5_ROLLUP



6_ROLLMAT



7_ONVASINX



8_ONVASINX



LAVELLI



ONE



INSTALLAZIONE
SOTTO-TOP

Nella versione sotto-top il lavello viene rifilato anteriormente e posteriormente così da ridurre la profondità. Per il fissaggio viene fornita di serie l'apposita ferramenta (code GANCIST06).







FINITURE



PLUS



ARIA PURA



ITALIAN
TECHNOLOGY



100% ECO
COMPATIBILE

CORREDO

- Piletta
- Sifone
- Ganci

INSTALLAZIONE

- Standard (pag. 78-82)
- **Sotto-top**
- Integrata (pag. 98)

ONE - installazione sotto-top
**CARATTERISTICHE
 DI PRODOTTO**

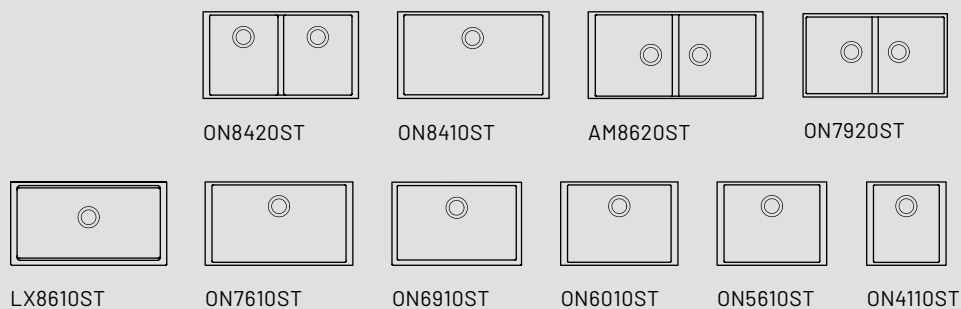

**DESIGN
 MINIMAL**

La serie One, grazie al suo design moderno e funzionale, e ai raggi interni molto stretti, si sposa perfettamente con le cucine minimaliste e di tendenza.



**LAVELLI
 MULTIACCESSORIATI**

Accessori di ogni tipologia a corredo della serie ONE: taglieri, vaschette, cestelli, copri-piletta creano una vera e propria stazione di lavoro in cucina.



**GAMMA
 COLORI**

La linea ONE è disponibile in tutti i colori ed in tutte e 3 le nostre finiture.

MISCELATORI CONSIGLIATI



NEMO
 pag. 202



PARMIXEXT
 pag. 208

REALTÀ AUMENTATA



Inquadra il qr-code con il tuo smartphone per scoprire i nostri lavelli in realtà aumentata.

ON8420ST / ONE

Lavello a due vasche
838x470 mm - Base da 90 cm

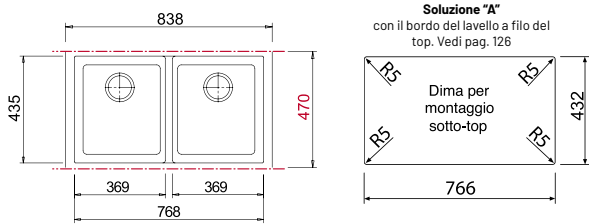



Foro per l'incasso: 766x432 mm
ATTENZIONE: Lavello profondo 47 cm

ACCESSORI: 4, 5

MICROULTRAGRANIT



€ IVA esclusa

-  UG 70
NERO MATT
ON8420ST / 70
-  UG 72
TARTUFO
ON8420ST / 72
-  UG 98
BIANCO
ON8420ST / 98

556

ULTRAMETAL

€ IVA esclusa

-  UM 41
ALLUMINIO
ON8420ST / 41
-  UM 42
TITANIO
ON8420ST / 42
-  UM 44
NERO
ON8420ST / 44

584

ON8410ST / ONE

Lavello a una vasca
838x510 mm - Base da 90 cm

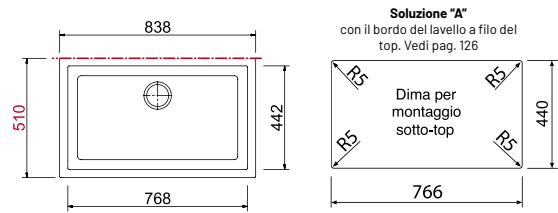



Foro per l'incasso: 765x440 mm
ATTENZIONE: Lavello profondo 51 cm

ACCESSORI: 4, 9

MICROULTRAGRANIT

€ IVA esclusa

-  UG 70
NERO MATT
ON8410ST / 70
-  UG 72
TARTUFO
ON8410ST / 72
-  UG 98
BIANCO
ON8410ST / 98

520

ULTRAMETAL

€ IVA esclusa

-  UM 41
ALLUMINIO
ON8410ST / 41
-  UM 42
TITANIO
ON8410ST / 42
-  UM 44
NERO
ON8410ST / 44

548

ACCESSORI CONSIGLIATI



1_COPHPLON



2_TAGL44



3_ONTAGCR



4_SPCESINX



5_ROLLUP



6_ROLLMAT

AM8620ST / ELEGANCE

Lavello a due vasche
860x435 mm - Base da 90 cm

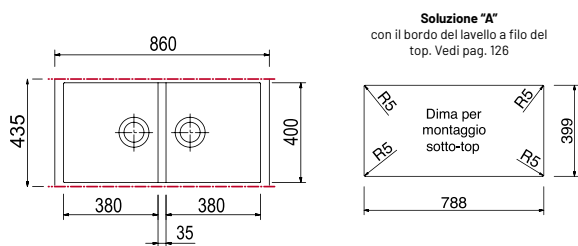



Foro per l'incasso: 788x399 mm

ACCESSORI: 1, 2, 3, 4, 5, 6, 7, 8

MICROULTRAGRANIT

€ IVA esclusa



-  UG 56 JASMINE
AM8620ST / 56
-  UG 70 NERO MATT
AM8620ST / 70
-  UG 72 TARTUFO
AM8620ST / 72
-  UG 90 BIANCO OPALE
AM8620ST / 90
-  UG 94 AVENA
AM8620ST / 94
-  UG 95 NERO EBONY
AM8620ST / 95
-  UG 98 BIANCO
AM8620ST / 98



414

ULTRAMETAL

€ IVA esclusa





-  UM 41 ALLUMINIO
AM8620ST / 41
-  UM 42 TITANIO
AM8620ST / 42
-  UM 14 CONCRETE
AM8620ST / 14
-  UM 44 NERO
AM8620ST / 44



436

NANOSTONE

€ IVA esclusa

-  NS N1 BIANCO LATTE
AM8620ST / N1
-  NS N3 ARGAN
AM8620ST / N3
-  NS N4 URBAN GREY
AM8620ST / N4
-  NS N6 DEEP BLACK
AM8620ST / N6



508

ON7920ST / ONE

Lavello a due vasche
755x435 mm - Base da 80 cm

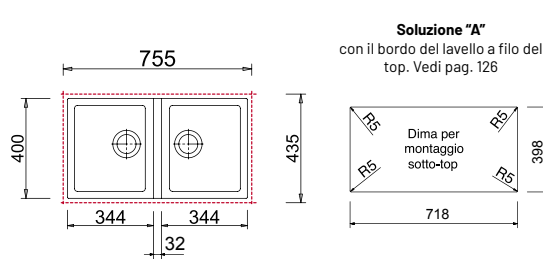

Foro per l'incasso: 718x398 mm

ACCESSORI: 1, 2, 3, 4, 5, 6, 7, 8

MICROULTRAGRANIT

€ IVA esclusa

-  UG 56 JASMINE
ON7920ST / 56
-  UG 70 NERO MATT
ON7920ST / 70
-  UG 72 TARTUFO
ON7920ST / 72
-  UG 90 BIANCO OPALE
ON7920ST / 90
-  UG 94 AVENA
ON7920ST / 94
-  UG 95 NERO EBONY
ON7920ST / 95
-  UG 98 BIANCO
ON7920ST / 98



418

ULTRAMETAL

€ IVA esclusa



-  UM 41 ALLUMINIO
ON7920ST / 41
-  UM 42 TITANIO
ON7920ST / 42
-  UM 14 CONCRETE
ON7920ST / 14
-  UM 44 NERO
ON7920ST / 44



442

NANOSTONE

€ IVA esclusa

-  NS N1 BIANCO LATTE
ON7920ST / N1
-  NS N3 ARGAN
ON7920ST / N3
-  NS N4 URBAN GREY
ON7920ST / N4
-  NS N6 DEEP BLACK
ON7920ST / N6



512



7_ONVASINX



8_ONVASINX

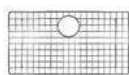

9_GRID84

LX8610ST / LUX

Lavello a una vasca
860x435 mm - Base da 90 cm

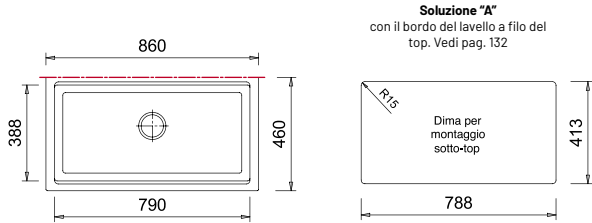

Foro per l'incasso: 788x416 mm

ACCESSORI: 1, 5, 6, 7, 8, 10

ON7610ST / ONE

Lavello a una vasca
760x435 mm - Base da 80 cm

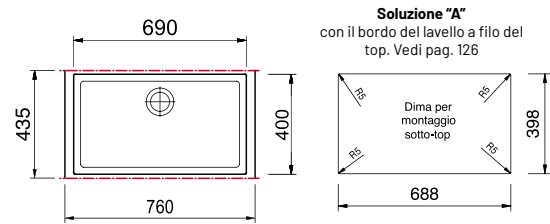

Foro per l'incasso: 688x398 mm

ACCESSORI: 2, 3, 4, 5, 6, 7, 9, 11, 12

MICROULTRAGRANIT

€ IVA esclusa

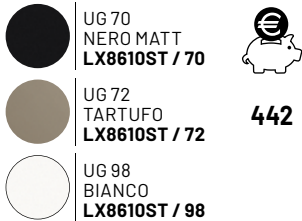

ULTRAMETAL

€ IVA esclusa

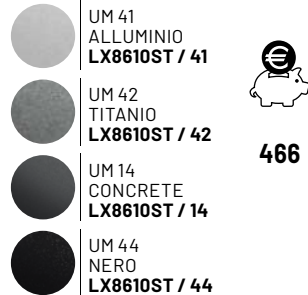

NANOSTONE

€ IVA esclusa

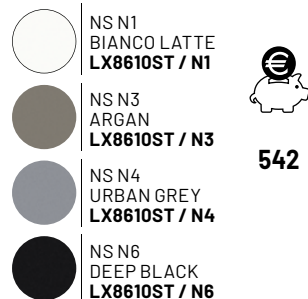

MICROULTRAGRANIT

€ IVA esclusa

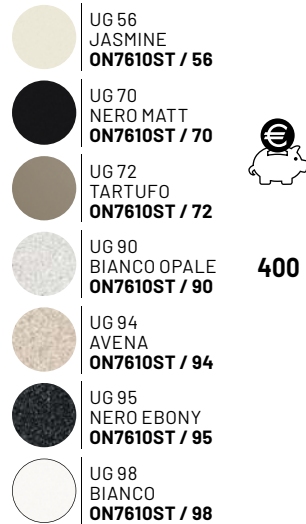

ULTRAMETAL

€ IVA esclusa

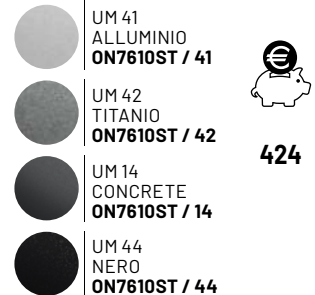

NANOSTONE

€ IVA esclusa

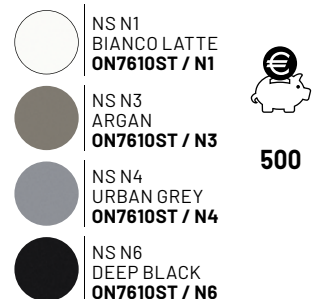

ACCESSORI CONSIGLIATI



1_COPHPLX2



2_COPHPLON



3_TAGL44



4_ONTAGCR



5_SPCESINX



6_ROLLUP

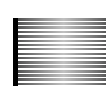

7_ROLLMAT

ON6910ST / ONE

Lavello a una vasca
690x443 mm - Base da 75 cm

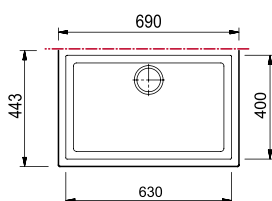

Soluzione "A"
con il bordo del lavello a filo del top. Vedi pag. 126

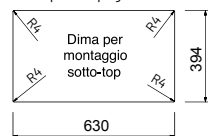

Foro per l'incasso: 630x394 mm

ACCESSORI: 2, 3, 4, 5, 6, 7, 9, 11

MICROULTRAGRANIT





€ IVA esclusa

-  UG 56 JASMINE
ON6910ST / 56
-  UG 70 NERO MATT
ON6910ST / 70
-  UG 72 TARTUFO
ON6910ST / 72
-  UG 90 BIANCO OPALE
ON6910ST / 90
-  UG 94 AVENA
ON6910ST / 94
-  UG 95 NERO EBONY
ON6910ST / 95
-  UG 98 BIANCO
ON6910ST / 98

428

ULTRAMETAL





€ IVA esclusa

-  UM 41 ALLUMINIO
ON6910ST / 41
-  UM 42 TITANIO
ON6910ST / 42
-  UM 14 CONCRETE
ON6910ST / 14
-  UM 44 NERO
ON6910ST / 44

456

NANOSTONE

€ IVA esclusa

-  NS N1 BIANCO LATTE
ON6910ST / N1
-  NS N3 ARGAN
ON6910ST / N3
-  NS N4 URBAN GREY
ON6910ST / N4
-  NS N6 DEEP BLACK
ON6910ST / N6

538

ON6010ST / ONE

Lavello a una vasca
600x440 mm - Base da 80 cm

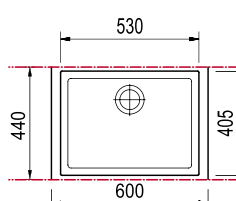

Soluzione "A"
con il bordo del lavello a filo del top. Vedi pag. 126

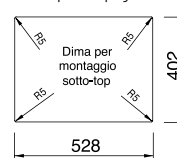

Foro per l'incasso: 528x402 mm

ACCESSORI: 2, 3, 4, 5, 6, 7, 9, 11

MICROULTRAGRANIT

€ IVA esclusa

-  UG 56 JASMINE
ON6010ST / 56
-  UG 98 BIANCO
ON6010ST / 98
-  UG 70 NERO MATT
ON6010ST / 70
-  UG 72 TARTUFO
ON6010ST / 72
-  UG 90 BIANCO OPALE
ON6010ST / 90
-  UG 94 AVENA
ON6010ST / 94
-  UG 95 NERO EBONY
ON6010ST / 95

376

ULTRAMETAL





€ IVA esclusa

-  UM 41 ALLUMINIO
ON6010ST / 41
-  UM 42 TITANIO
ON6010ST / 42
-  UM 14 CONCRETE
ON6010ST / 14
-  UM 44 NERO
ON6010ST / 44

400

NANOSTONE

€ IVA esclusa

-  NS N1 BIANCO LATTE
ON6010ST / N1
-  NS N3 ARGAN
ON6010ST / N3
-  NS N4 URBAN GREY
ON6010ST / N4
-  NS N6 DEEP BLACK
ON6010ST / N6

476



8_LXVASINX



9_ONVASINX



10_VAS70LX



11_ONVASINX

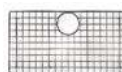

12_GRID76



13_GRID60

ON5610ST / ONE

Lavello a una vasca
560x435 mm - Base da 60 cm

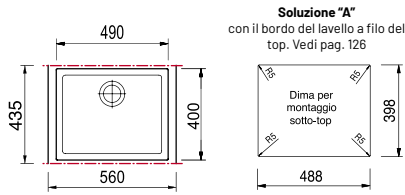

Foro per l'incasso: 488x398 mm

ACCESSORI: 1, 2, 3, 4, 5, 6, 7, 8, 9

MICROULTRAGRANIT

€ IVA esclusa

-  UG 56 JASMINE
ON5610ST / 56
-  UG 70 NERO MATT
ON5610ST / 70
-  UG 72 TARTUFO
ON5610ST / 72
-  UG 90 BIANCO OPALE
ON5610ST / 90
-  UG 94 AVENA
ON5610ST / 94
-  UG 95 NERO EBONY
ON5610ST / 95
-  UG 98 BIANCO
ON5610ST / 98



376

ULTRAMETAL

€ IVA esclusa

-  UM 41 ALLUMINIO
ON5610ST / 41
-  UM 42 TITANIO
ON5610ST / 42
-  UM 14 CONCRETE
ON5610ST / 14
-  UM 44 NERO
ON5610ST / 44



400

NANOSTONE

€ IVA esclusa

-  NS N1 BIANCO LATTE
ON5610ST / N1
-  NS N3 ARGAN
ON5610ST / N3
-  NS N4 URBAN GREY
ON5610ST / N4
-  NS N6 DEEP BLACK
ON5610ST / N6



476

ON4110ST / ONE

Lavello a una vasca
410x435 mm - Base da 45 cm

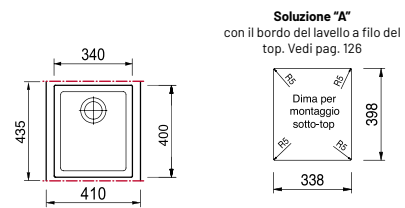







Foro per l'incasso: 338x398 mm

ACCESSORI: 1, 2, 3, 4, 5, 6, 7, 8

MICROULTRAGRANIT

€ IVA esclusa





-  UG 56 JASMINE
ON4110ST / 56
-  UG 70 NERO MATT
ON4110ST / 70
-  UG 72 TARTUFO
ON4110ST / 72
-  UG 90 BIANCO OPALE
ON4110ST / 90
-  UG 94 AVENA
ON4110ST / 94
-  UG 95 NERO EBONY
ON4110ST / 95
-  UG 98 BIANCO
ON4110ST / 98



324

ULTRAMETAL

€ IVA esclusa

-  UM 41 ALLUMINIO
ON4110ST / 41
-  UM 42 TITANIO
ON4110ST / 42
-  UM 14 CONCRETE
ON4110ST / 14
-  UM 44 NERO
ON4110ST / 44



348

NANOSTONE

€ IVA esclusa

-  NS N1 BIANCO LATTE
ON4110ST / N1
-  NS N3 ARGAN
ON4110ST / N3
-  NS N4 URBAN GREY
ON4110ST / N4
-  NS N6 DEEP BLACK
ON4110ST / N6



424

ACCESSORI CONSIGLIATI



1_COPHLON



2_TAGL44



3_ONTAGCR



4_SPCESINX



5_ROLLUP

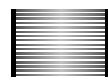

6_ROLLMAT



7_ONVASINX



8_ONVASINX

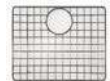

9_GRID60



LAVELLI



ONE



INSTALLAZIONE
INTEGRATA

Nella versione per installazione integrata il perimetro del lavello viene fresato sia lateralmente che superficialmente: questa lavorazione rende il bordo perimetrale perfettamente piatto e quindi idoneo ad essere integrato al top.







FINITURE



PLUS



ARIA PURA



ITALIAN
TECHNOLOGY



100% ECO
COMPATIBILE

CORREDO

- Piletta
- Sifone
- Ganci

INSTALLAZIONE

- Standard (pag. 78-82)
- Sotto-top (pag. 88-92)
- **Integrata**

ATTENZIONE: In caso di richiesta, da parte del consumatore, di sostituzione del lavello per rottura da shock termico, l'azienda provvederà alla sostituzione dello stesso con il medesimo modello, ma nella tradizionale versione da incasso.

ONE - installazione integrata

CARATTERISTICHE DI PRODOTTO

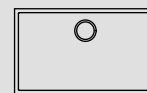

ON7610IT

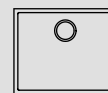

ON5610IT



COLORI AD HOC

I colori NANOSTONE sono stati studiati per abbinarsi perfettamente ai piani di lavoro.



LAVELLI MULTIACCESSORIATI

Accessori di ogni tipologia a corredo della serie ONE: taglieri, vaschette, cestelli, copri-piletta creano una vera e propria stazione di lavoro in cucina.

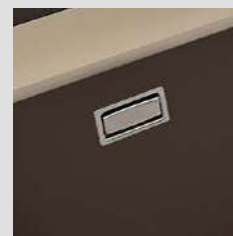

TROPPOPIENO RETTANGOLARE

La linea ONE per installazione integrata ha l'elegante troppopieno rettangolare di serie.

MISCELATORI CONSIGLIATI

REALTÀ AUMENTATA



NEMO
pag. 202



PUNTOBPEX
pag. 208



Inquadra il qr-code con il tuo smartphone per scoprire i nostri lavelli in realtà aumentata.

ON7610IT / ONE

Lavello a una vasca
730x435 mm - Base da 80 cm

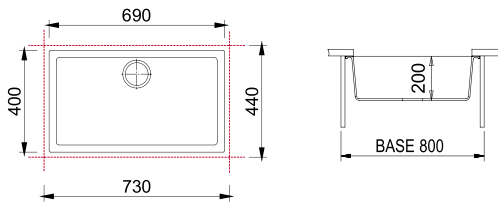

ON5610IT / ONE



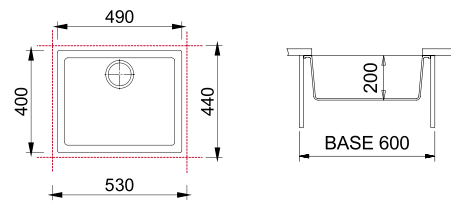

Lavello a una vasca
530x435 mm - Base da 60 cm



ACCESSORI: 1, 2, 3, 4, 5, 6, 7, 8, 9

NANOSTONE





€ IVA
esclusa

	NS N1 BIANCO LATTE ON7610IT / N1	592
	NS N3 ARGAN ON7610IT / N3	
	NS N4 URBAN GREY ON7610IT / N4	
	NS N6 DEEP BLACK ON7610IT / N6	

ACCESSORI: 1, 2, 3, 4, 5, 6, 7, 8, 10

NANOSTONE

€ IVA
esclusa

	NS N1 BIANCO LATTE ON5610IT / N1	566
	NS N3 ARGAN ON5610IT / N3	
	NS N4 URBAN GREY ON5610IT / N4	
	NS N6 DEEP BLACK ON5610IT / N6	

Il copri-piletta COPPILT10 visibile nelle immagini è un accessorio optional.

ACCESSORI CONSIGLIATI



1_COPHPLON



2_TAGL44



3_ONTAGCR



4_SPCESINX



5_ROLLUP



6_ROLLMAT



7_ONVASINX



8_ONVASINX

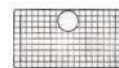

9_GRID76



10_GRID60

TOP & LAVELLO COORDINATI PER INSTALLAZIONE INTEGRATA

Abbinamenti suggeriti dei **colori nanoSTONE** Plados con i colori dei principali produttori di **piani di lavoro**

PRINCIPALI
PRODUTTORI DI
PIANI DI LAVORO

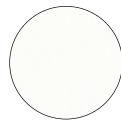

nanoSTONE
N1 Bianco Latte



nanoSTONE
N3 Argan



nanoSTONE
N4 Urban Grey

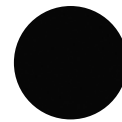

nanoSTONE
N6 Deep Black

PIETRE SINTETIZZATE O GRES CERAMICA

DEKTON	• ZENITH • OPERA • KAIROS	• GALEMA	• KORUS • VENTUS • TRILIUM	• DOMOOS • SIRIUS • KELIA
LAMINAM	• BIANCO ASSOLUTO • ARABESCATO • OPACO fin. CAVA	• TERRA fin. FOKOS	• GRIGIO fin. CALCE	• NERO ASSOLUTO • NERO fin. BLEND • NERO fin. CALCE • OSSIDO NERO
IRIS/ SAPIEN STONE	• UNI ICE • CALACATTA	• SAND EARTH	• URBAN ARGENTO • LIGHT EARTH	• URBAN ANTRACITE • NOIR • MALM BLACK
FLORIM	• COLOR WHITE	• STONE BROWN	• CEMENT LIGHT GREY	• COLOR BLACK • MARBLE MARQUINIA
INFINITY	• ABSOLUTE WHITE • TOTAL WHITE		• TUNDRA SELECT • CONCRETE LIGHT	• TOTAL BLACK MATT • NERO MARQUINIA
LAPITEC	• BIANCO ASSOLUTO	• AVANA • MOCA	• GRIGIO CEMENTO	• NERO ASSOLUTO • EBANO
KERLITE	• MATERICA BIANCO • VANITY • BIANCO LUCE • ULTRA WHITE	• MATERICA TORTORA • ELEGANCE • VIA FARINI	• ELEGANCE • VIA TORNABUONI • OVER OFFICE	• BLACK • MATERICA ARDESIA • OVER ROAD

AGGLOMERATI IN QUARZO

SILESTONE	• BIANCO ZEUS • MIAMI WHITE • WHITE STORM	• UNSUI • NOKA • ROUGUI	• KENSHO	• NEGRO TEBAS • MARQUINIA
QUARTZFORM	• WHITE	• DESERT	• LIGHT GREY	• BLACK
STONE ITALIANA	• SUPER WHITE • CANDIDO • VIRGO • CRISTAL WHITE	• TERRA • GREIGE • TAUPE	• PITTI • ELEPHANT GREY	• IMPERIALE • MAGMA GREY
OKITE	• BIANCO • CALACATTA	• EASY BRONZE	• GRIGIO ORIENTE • EASY GREY	• NERO ASSOLUTO • MARQUINIA BLACK • CORVINO • PRISMA NERO
SANTAMARGHERITA	• ZENITH • VEGA • EASY WHITE • ALTEA • BIANCO NEVE	• MOSA • ELBA • METROPOLIS COPPER • OREGON	• LINO • GRIGIO PERLA • AMIATA	• NERO • METROPOLIS GALAXY • ARDENNE • IRON
ILEXA	• ABSOLUTE BLANC • JAVA WHITE • BIANCO • GLACIAR • LUNA • ALASKA	• JAVA TAUPE • TORTORA • FOX GREY • DIM GREY	• CENIZA • CEMENTO	• JAVA BLACK • ROYAL BLACK



LAVELLI

ELEGANCE

Essenziale, lineare, Elegance è un concentrato di stile e modernità e può essere convenientemente installata in qualsiasi tipologia di cucine componibili. Le linee squadrate e il bordo superiore ampio e completamente piatto consentono di utilizzare questi modelli anche per il montaggio sotto-top.





FINITURE



PLUS



ARIA PURA



ITALIAN
TECHNOLOGY



100% ECO
COMPATIBILE

CORREDO

- Piletta
- Sifone
- Ganci

INSTALLAZIONE

- Standard
- Sotto-top

ELEGANCE

CARATTERISTICHE DI PRODOTTO

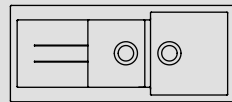

AM11620

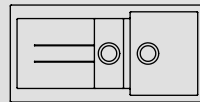

AM9915

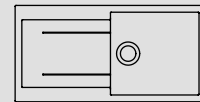

AM9910

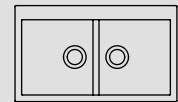

AM8620

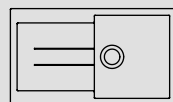

AM8610

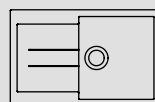

AM7810

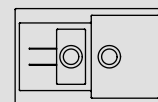

AM7815

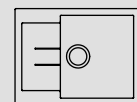

AM6510



MAXI VASCHE

Le maxi vasche dei lavelli ELEGANCE, praticissime grazie alle grandi dimensioni, sono una soluzione ideale per una cucina spaziosa e per le famiglie numerose.

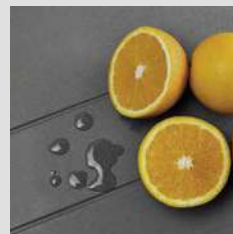

DESIGN MINIMAL

Un concentrato di stile e modernità per abbinarsi ad ambienti contemporanei e lineari.



ACCESSORI CON STILE

I taglieri scorrevoli in HPL, in legno iroko o in polietilene trasformano il lavello in un pratico centro per la preparazione di cibi.

MISCELATORI CONSIGLIATI



NEWMIX80
pag. 196



VENMIXL
pag. 211

AM11620 / ELEGANCE

Lavello a due vasche più scolapiatti - Reversibile
1160x500 mm - Base da 80 cm

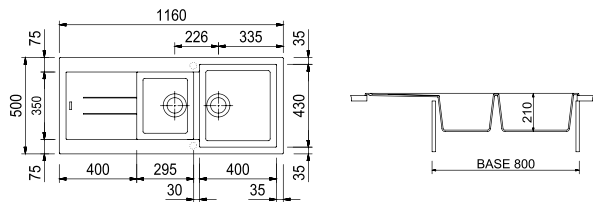

Foro per l'incasso: 1140x480 mm

ACCESSORI: 2, 4, 6, 9, 10, 11

AM9915 / ELEGANCE

Lavello a una vasca grande più una vasca piccola più scolapiatti
Reversibile - 990x500 mm - Base da 60 cm

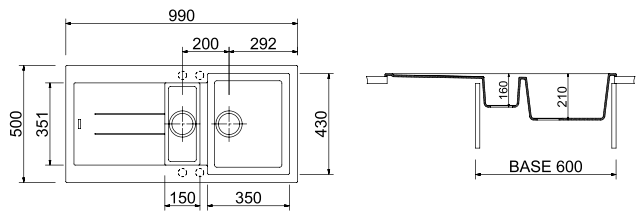

Foro per l'incasso: 970x480 mm

ACCESSORI: 2, 4, 6, 9, 10, 11

MICROULTRAGRANIT

€ IVA esclusa

UG 56 JASMINE
AM11620 / 56

UG 70 NERO MATT
AM11620 / 70

UG 72 TARTUFO
AM11620 / 72

UG 90 BIANCO OPALE
AM11620 / 90

UG 94 AVENA
AM11620 / 94

UG 95 NERO EBONY
AM11620 / 95

UG 98 BIANCO
AM11620 / 98



406

ULTRAMETAL

€ IVA esclusa

UM 41 ALLUMINIO
AM11620 / 41

UM 42 TITANIO
AM11620 / 42

UM 14 CONCRETE
AM11620 / 14

UM 44 NERO
AM11620 / 44



430

NANOSTONE

€ IVA esclusa

NS N1 BIANCO LATTE
AM11620 / N1

NS N3 ARGAN
AM11620 / N3

NS N4 URBAN GREY
AM11620 / N4

NS N6 DEEP BLACK
AM11620 / N6



500

MICROULTRAGRANIT

€ IVA esclusa

UG 56 JASMINE
AM9915 / 56

UG 70 NERO MATT
AM9915 / 70

UG 72 TARTUFO
AM9915 / 72

UG 90 BIANCO OPALE
AM9915 / 90

UG 94 AVENA
AM9915 / 94

UG 95 NERO EBONY
AM9915 / 95

UG 98 BIANCO
AM9915 / 98

474

ULTRAMETAL

€ IVA esclusa

UM 41 ALLUMINIO
AM9915 / 41

UM 42 TITANIO
AM9915 / 42

UM 14 CONCRETE
AM9915 / 14

UM 44 NERO
AM9915 / 44

502

NANOSTONE

€ IVA esclusa

NS N1 BIANCO LATTE
AM9915 / N1

NS N3 ARGAN
AM9915 / N3

NS N4 URBAN GREY
AM9915 / N4

NS N6 DEEP BLACK
AM9915 / N6

584

ACCESSORI CONSIGLIATI



1_COPHLON



2_TAGL88



3_TAGL44



4_TAGP66



5_ONTAGCR



6_TAGCR



7_ONVASINX



8_VAS700N

AM9910 / ELEGANCE

Lavello a una vasca più scolapiatti - Reversibile
990x500 mm - Base da 60 cm

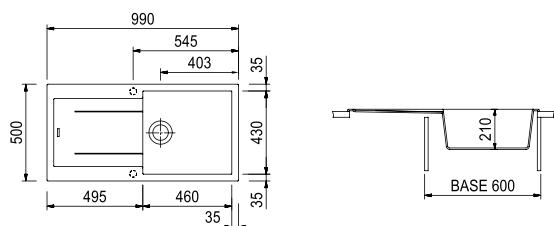

Foro per l'incasso: 970x480 mm

ACCESSORI: 2, 4, 6, 9, 10, 11

MICROULTRAGRANIT

€ IVA esclusa





-  UG 56 JASMINE
AM9910 / 56
-  UG 70 NERO MATT
AM9910 / 70
-  UG 72 TARTUFO
AM9910 / 72
-  UG 90 BIANCO OPALE
AM9910 / 90
-  UG 94 AVENA
AM9910 / 94
-  UG 95 NERO EBONY
AM9910 / 95
-  UG 98 BIANCO
AM9910 / 98



400

ULTRAMETAL

€ IVA esclusa

-  UM 41 ALLUMINIO
AM9910 / 41
-  UM 42 TITANIO
AM9910 / 42
-  UM 14 CONCRETE
AM9910 / 14
-  UM 44 NERO
AM9910 / 44



420

NANOSTONE

€ IVA esclusa

-  NS N1 BIANCO LATTE
AM9910 / N1
-  NS N3 ARGAN
AM9910 / N3
-  NS N4 URBAN GREY
AM9910 / N4
-  NS N6 DEEP BLACK
AM9910 / N6



494

AM8620 / ELEGANCE

Lavello a due vasche
860x510 mm - Base da 90 cm

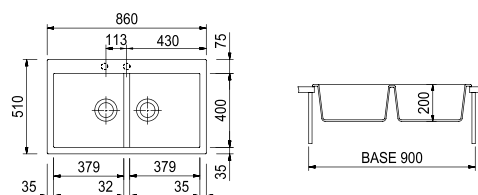



Foro per l'incasso: 840x480 mm

ACCESSORI: 1, 3, 5, 7, 8, 9, 10, 11

MICROULTRAGRANIT

€ IVA esclusa





-  UG 56 JASMINE
AM8620 / 56
-  UG 70 NERO MATT
AM8620 / 70
-  UG 72 TARTUFO
AM8620 / 72
-  UG 90 BIANCO OPALE
AM8620 / 90
-  UG 94 AVENA
AM8620 / 94
-  UG 95 NERO EBONY
AM8620 / 95
-  UG 98 BIANCO
AM8620 / 98



390

ULTRAMETAL

€ IVA esclusa



-  UM 41 ALLUMINIO
AM8620 / 41
-  UM 42 TITANIO
AM8620 / 42
-  UM 14 CONCRETE
AM8620 / 14
-  UM 44 NERO
AM8620 / 44



414

NANOSTONE

€ IVA esclusa

-  NS N1 BIANCO LATTE
AM8620 / N1
-  NS N3 ARGAN
AM8620 / N3
-  NS N4 URBAN GREY
AM8620 / N4
-  NS N6 DEEP BLACK
AM8620 / N6



484



9_SPCESINX



10_ROLLUP



11_ROLLMAT

AM8610 / ELEGANCE

Lavello a una vasca più scolapiatti - Reversibile
860x500 mm - Base da 50 cm

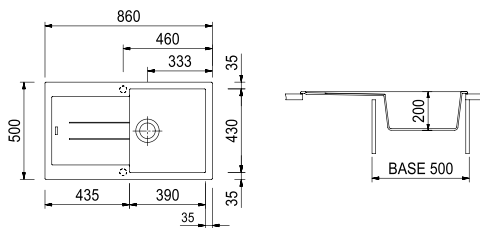

Foro per l'incasso: 840x480 mm

ACCESSORI: 1, 2, 3, 4, 5

AM7810 / ELEGANCE

Lavello a una vasca più scolapiatti - Reversibile
780x500 mm - Base da 50 cm

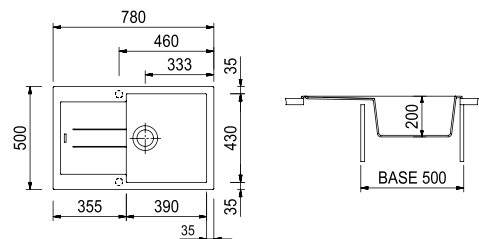

Foro per l'incasso: 760x480 mm

ACCESSORI: 1, 2, 3, 4, 5

MICROULTRAGRANIT

€ IVA esclusa

UG 56 JASMINE
AM8610 / 56

UG 70 NERO MATT
AM8610 / 70

UG 72 TARTUFO
AM8610 / 72

UG 90 BIANCO OPALE
AM8610 / 90

UG 94 AVENA
AM8610 / 94

UG 95 NERO EBONY
AM8610 / 95

UG 98 BIANCO
AM8610 / 98



366

ULTRAMETAL

€ IVA esclusa

UM 41 ALLUMINIO
AM8610 / 41

UM 42 TITANIO
AM8610 / 42

UM 14 CONCRETE
AM8610 / 14

UM 44 NERO
AM8610 / 44



390

NANOSTONE

€ IVA esclusa

NS N1 BIANCO LATTE
AM8610 / N1

NS N3 ARGAN
AM8610 / N3

NS N4 URBAN GREY
AM8610 / N4

NS N6 DEEP BLACK
AM8610 / N6



460

MICROULTRAGRANIT

€ IVA esclusa

UG 56 JASMINE
AM7810 / 56

UG 70 NERO MATT
AM7810 / 70

UG 72 TARTUFO
AM7810 / 72

UG 94 AVENA
AM7810 / 94

UG 98 BIANCO
AM7810 / 98

434

ULTRAMETAL

€ IVA esclusa

UM 41 ALLUMINIO
AM7810 / 41

UM 42 TITANIO
AM7810 / 42

UM 44 NERO
AM7810 / 44

460

ACCESSORI CONSIGLIATI



1_TAGL88



2_TAGP66



3_TAGCR



4_SPCESINX

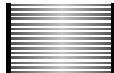

5_ROLLMAT



6_SPVASPOL

AM7815 / ELEGANCE

Lavello a una vasca grande più una vasca piccola più scolapiatti
Reversibile - 780x500 mm - Base da 60 cm

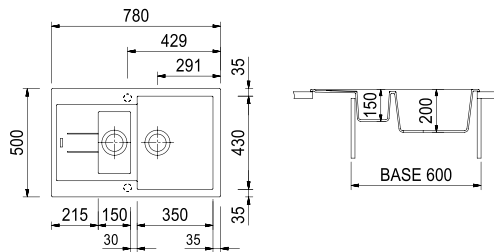





Foro per l'incasso: 760x480 mm

ACCESSORI: 1, 2, 3, 4, 5, 6

MICROULTRAGRANIT



€ IVA esclusa

-  UG 56
JASMINE
AM7815 / 56
-  UG 70
NERO MATT
AM7815 / 70
-  UG 72
TARTUFO
AM7815 / 72
-  UG 94
AVENA
AM7815 / 94
-  UG 98
BIANCO
AM7815 / 98

460

ULTRAMETAL

€ IVA esclusa

-  UM 41
ALLUMINIO
AM7815 / 41
-  UM 42
TITANIO
AM7815 / 42
-  UM 44
NERO
AM7815 / 44

488

AM6510 / ELEGANCE

Lavello a una vasca più scolapiatti - Reversibile
650x500 mm - Base da 50 cm

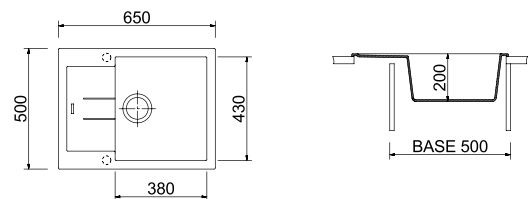

Foro per l'incasso: 630x480 mm

ACCESSORI: 1, 2, 3, 4, 5

MICROULTRAGRANIT



€ IVA esclusa

-  UG 56
JASMINE
AM6510 / 56
-  UG 70
NERO MATT
AM6510 / 70
-  UG 72
TARTUFO
AM6510 / 72
-  UG 94
AVENA
AM6510 / 94
-  UG 98
BIANCO
AM6510 / 98

416

ULTRAMETAL

€ IVA esclusa

-  UM 41
ALLUMINIO
AM6510 / 41
-  UM 42
TITANIO
AM6510 / 42
-  UM 44
NERO
AM6510 / 44

442



LAVELLI



INFINITY

Linee decise, perfetta proporzione tra le ampie vasche e la superficie d'appoggio: Infinity è la linea dei lavelli che predilige praticità e bellezza estetica. Il design minimal e rigoroso esalta le caratteristiche tecnologiche della nuova finitura nanoSTONE, donando un gradevole effetto seta al tatto e maggiore robustezza alla struttura del lavello per renderlo più resistente e confortevole nel tempo.



FINITURE



PLUS



ARIA PURA



ITALIAN
TECHNOLOGY



100% ECO
COMPATIBILE

CORREDO

- Piletta
- Sifone
- Ganci

INSTALLAZIONE

- Standard

INFINITY

CARATTERISTICHE DI PRODOTTO

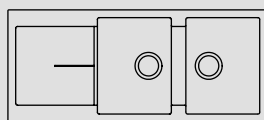

NF11620

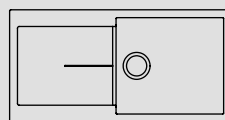

NF9910

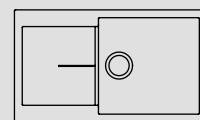

NF8610



MAXI VASCHE

Le maxi vasche dei lavelli INFINITY, praticissime grazie alle grandi dimensioni, sono una soluzione ideale per una cucina spaziosa e per le famiglie numerose.



DESIGN MINIMAL

Linee decise, perfetta proporzione tra le vasche e la superficie d'appoggio: Infinity è la linea dei lavelli che predilige praticità e bellezza estetica.



ACCESSORI CON STILE

I taglieri scorrevoli in HPL, in legno iroko o in polietilene trasformano il lavello in un pratico centro per la preparazione di cibi.

MISCELATORI CONSIGLIATI



SPRINGP40
pag. 194



NILO
pag. 200

REALTÀ AUMENTATA



Inquadra il qr-code con il tuo smartphone per scoprire i nostri lavelli in realtà aumentata.

NF11620 / INFINITY

Lavello a due vasche più scolapiatti - Reversibile
1160x500 mm - Base da 80 cm

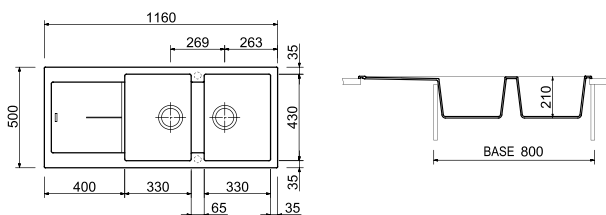



Foro per l'incasso: 1140x480 mm

ACCESSORI: 1, 2, 3, 4, 5

MICROULTRAGRANIT

€ IVA esclusa

-  UG 70
NERO MATT
NF11620 / 70
-  UG 72
TARTUFO
NF11620 / 72
-  UG 98
BIANCO
NF11620 / 98



366

NANOSTONE

€ IVA esclusa





-  NS N1
BIANCO LATTE
NF11620 / N1
-  NS N3
ARGAN
NF11620 / N3
-  NS N4
URBAN GREY
NF11620 / N4
-  NS N6
DEEP BLACK
NF11620 / N6



460

ULTRAMETAL

€ IVA esclusa

-  UM 41
ALLUMINIO
NF11620 / 41
-  UM 42
TITANIO
NF11620 / 42
-  UM 14
CONCRETE
NF11620 / 14
-  UM 44
NERO
NF11620 / 44



390

NF9910 / INFINITY

Lavello a una vasca più scolapiatti - Reversibile
990x500 mm - Base da 60 cm

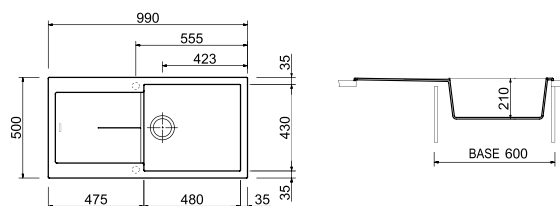



Foro per l'incasso: 970x480 mm

ACCESSORI: 1, 2, 3, 4, 5

MICROULTRAGRANIT

€ IVA esclusa



-  UG 70
NERO MATT
NF9910 / 70
-  UG 72
TARTUFO
NF9910 / 72
-  UG 98
BIANCO
NF9910 / 98



360

NANOSTONE

€ IVA esclusa





-  NS N1
BIANCO LATTE
NF9910 / N1
-  NS N3
ARGAN
NF9910 / N3
-  NS N4
URBAN GREY
NF9910 / N4
-  NS N6
DEEP BLACK
NF9910 / N6



454

ULTRAMETAL

€ IVA esclusa

-  UM 41
ALLUMINIO
NF9910 / 41
-  UM 42
TITANIO
NF9910 / 42
-  UM 14
CONCRETE
NF9910 / 14
-  UM 44
NERO
NF9910 / 44



382

ACCESSORI CONSIGLIATI



1_TAGL88



2_TAGP66



3_TAGCR



4_SPACESINX

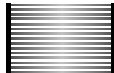

5_ROLLMAT

NF8610 / INFINITY

Lavello a una vasca più scolapiatti - Reversibile
860x500 mm - Base da 60 cm

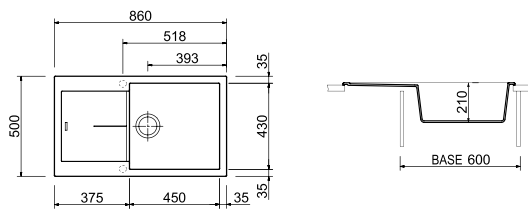



Foro per l'incasso: 840x480 mm

ACCESSORI: 1, 2, 3, 4, 5

MICROULTRAGRANIT

€ IVA esclusa





-  UG 70
NERO MATT
NF8610 / 70
-  UG 72
TARTUFO
NF8610 / 72
-  UG 98
BIANCO
NF8610 / 98



328

NANOSTONE

€ IVA esclusa





-  NS N1
BIANCO LATTE
NF8610 / N1
-  NS N3
ARGAN
NF8610 / N3
-  NS N4
URBAN GREY
NF8610 / N4
-  NS N6
DEEP BLACK
NF8610 / N6



420

ULTRAMETAL

€ IVA esclusa

-  UM 41
ALLUMINIO
NF8610 / 41
-  UM 42
TITANIO
NF8610 / 42
-  UM 14
CONCRETE
NF8610 / 14
-  UM 44
NERO
NF8610 / 44



352



LAVELLI



CORAX

Corax, caratterizzata da forme ricercate, è la linea Plados di alto profilo. Curata nei dettagli, si sposa perfettamente con le cucine moderne e di tendenza. I lavelli sono provvisti di un pratico gocciolatoio e di vasche ampie e molto profonde.



FINITURE



PLUS



ARIA PURA



ITALIAN
TECHNOLOGY



100% ECO
COMPATIBILE

CORREDO

- Piletta
- Sifone
- Ganci

INSTALLAZIONE

- Standard

CORAX

CARATTERISTICHE DI PRODOTTO

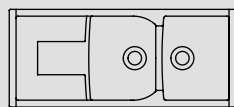

CX1162

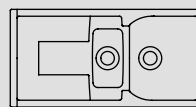

CX0991

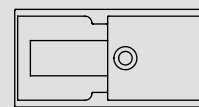

EL9910

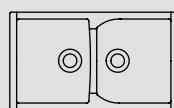

CX0862

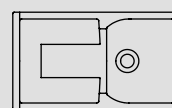

CX0861

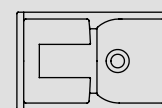

CX0791



VASCHE AMPIE E PROFONDE

Le vasche della serie CORAX sono profonde 23 cm.



DESIGN RICERCATO

Corax, caratterizzata da forme ricercate, è la linea Plados di alto profilo. Curata nei dettagli, si sposa perfettamente con le cucine moderne e di tendenza.



ACCESSORI CONSIGLIATI

Taglieri, cestelli e vaschette aggiungono praticità e design alle funzioni di lavaggio e preparazione dei cibi.

MISCELATORI CONSIGLIATI



NEWMIX90
pag. 196



SPIRIT
pag. 200

CX1162 / CORAX

Lavello a due vasche più scolapiatti - Reversibile
1160x500 mm - Base da 80 cm

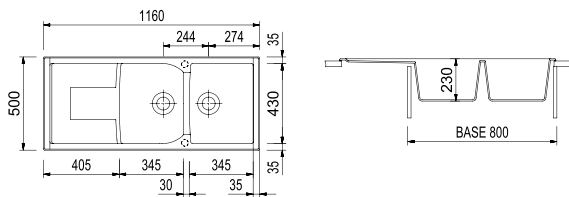

Foro per l'incasso: 1140x480 mm

ACCESSORI: 1, 2, 3, 4, 5

MICROULTRAGRANIT

€ IVA esclusa

ULTRAMETAL

€ IVA esclusa

-  UG 56 JASMINE
CX1162 / 56
-  UG 70 NERO MATT
CX1162 / 70
-  UG 72 TARTUFO
CX1162 / 72
-  UG 90 BIANCO OPALE
CX1162 / 90 **428**
-  UG 94 AVENA
CX1162 / 94
-  UG 95 NERO EBONY
CX1162 / 95
-  UG 98 BIANCO
CX1162 / 98

-  UM 41 ALLUMINIO
CX1162 / 41
-  UM 42 TITANIO
CX1162 / 42 **456**
-  UM 44 NERO
CX1162 / 44

CX0991 / CORAX

Lavello a una vasca grande più una vasca piccola più scolapiatti
Reversibile - 990x500 mm - Base da 60 cm

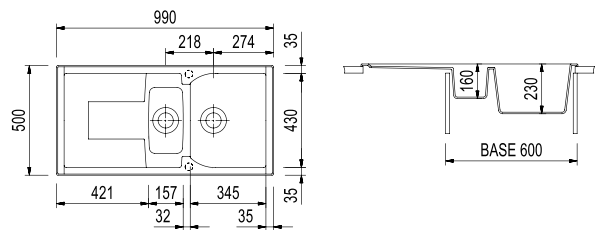

Foro per l'incasso: 970x480 mm







ACCESSORI: 1, 2, 3, 4, 5, 6



MICROULTRAGRANIT

€ IVA esclusa

ULTRAMETAL

€ IVA esclusa

-  UG 56 JASMINE
CX0991 / 56
-  UG 70 NERO MATT
CX0991 / 70
-  UG 72 TARTUFO
CX0991 / 72
-  UG 90 BIANCO OPALE
CX0991 / 90 **428**
-  UG 94 AVENA
CX0991 / 94
-  UG 95 NERO EBONY
CX0991 / 95
-  UG 98 BIANCO
CX0991 / 98

-  UM 41 ALLUMINIO
CX0991 / 41
-  UM 42 TITANIO
CX0991 / 42 **456**
-  UM 44 NERO
CX0991 / 44

ACCESSORI CONSIGLIATI



1_TAGL88

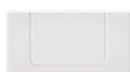

2_TAGP66



3_TAGCR



4_SPCESINX

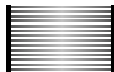

5_ROLLMAT



6_SPVASPOL

EL9910 / CORAX

Lavello a una vasca più scolapiatti - Reversibile
990x500 mm - Base da 60 cm

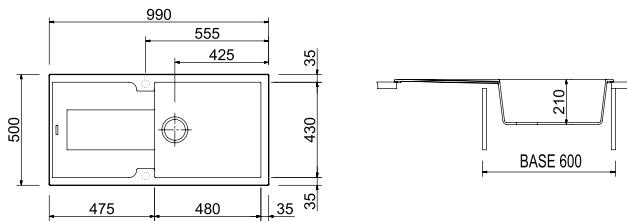
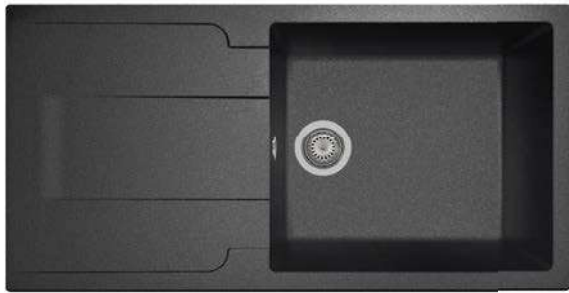

Foro per l'incasso: 970x480 mm

ACCESSORI: 1, 2, 3, 4, 5

MICROULTRAGRANIT



€ IVA esclusa

-  UG 70
NERO MATT
EL9910 / 70
-  UG 72
TARTUFO
EL9910 / 72
-  UG 94
AVENA
EL9910 / 94
-  UG 98
BIANCO
EL9910 / 98

420

ULTRAMETAL

€ IVA esclusa

-  UM 41
ALLUMINIO
EL9910 / 41
-  UM 42
TITANIO
EL9910 / 42
-  UM 44
NERO
EL9910 / 44

448

CX0862 / CORAX

Lavello a due vasche
860x500 mm - Base da 90 cm

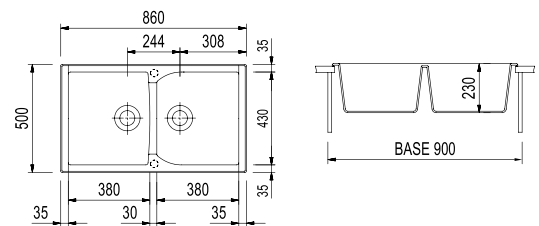



Foro per l'incasso: 840x480 mm

ACCESSORI: 1, 2, 3, 4, 5

MICROULTRAGRANIT



€ IVA esclusa

-  UG 56
JASMINE
CX0862 / 56
-  UG 70
NERO MATT
CX0862 / 70
-  UG 72
TARTUFO
CX0862 / 72
-  UG 90
BIANCO OPALE
CX0862 / 90
-  UG 94
AVENA
CX0862 / 94
-  UG 95
NERO EBONY
CX0862 / 95
-  UG 98
BIANCO
CX0862 / 98

402

ULTRAMETAL

€ IVA esclusa

-  UM 41
ALLUMINIO
CX0862 / 41
-  UM 42
TITANIO
CX0862 / 42
-  UM 44
NERO
CX0862 / 44

428

CX0861 / CORAX

Lavello a una vasca più scolapiatti - Reversibile
860x500 mm - Base da 45 cm

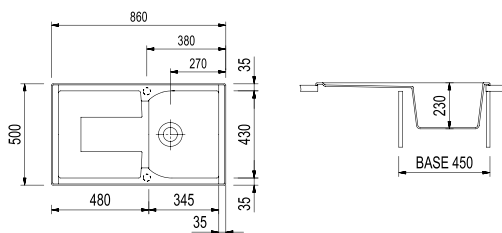

Foro per l'incasso: 840x480 mm

ACCESSORI: 1, 2, 3, 4, 5

MICROULTRAGRANIT

€ IVA esclusa

ULTRAMETAL

€ IVA esclusa

UG 56
JASMINE
CX0861 / 56

UG 70
NERO MATT
CX0861 / 70

UG 72
TARTUFO
CX0861 / 72

UG 90
BIANCO OPALE
CX0861 / 90

UG 94
AVENA
CX0861 / 94

UG 95
NERO EBONY
CX0861 / 95

UG 98
BIANCO
CX0861 / 98

UM 41
ALLUMINIO
CX0861 / 41

UM 42
TITANIO
CX0861 / 42

UM 44
NERO
CX0861 / 44

402

374

CX0791 / CORAX

Lavello a una vasca più scolapiatti - Reversibile
790x500 mm - Base da 45 cm

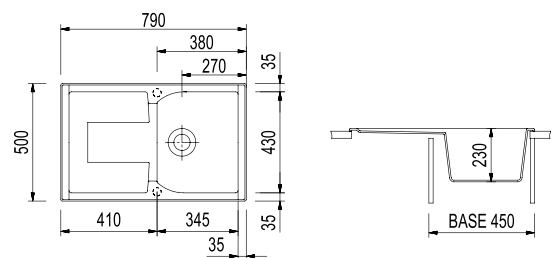

Foro per l'incasso: 770x480 mm

ACCESSORI: 1, 2, 3, 4, 5

MICROULTRAGRANIT

€ IVA esclusa

ULTRAMETAL

€ IVA esclusa

UG 56
JASMINE
CX0791 / 56

UG 70
NERO MATT
CX0791 / 70

UG 72
TARTUFO
CX0791 / 72

UG 90
BIANCO OPALE
CX0791 / 90

UG 94
AVENA
CX0791 / 94

UG 95
NERO EBONY
CX0791 / 95

UG 98
BIANCO
CX0791 / 98

UM 41
ALLUMINIO
CX0791 / 41

UM 42
TITANIO
CX0791 / 42

UM 44
NERO
CX0791 / 44

406

378

ACCESSORI CONSIGLIATI



1_TAGL88



2_TAGP66



3_TAGCR



4_SPCESINX



5_ROLLMAT





LAVELLI

ATLANTIC

Sobria, pulita e molto funzionale, la linea Atlantic è proposta in molte finiture e può essere convenientemente installata su qualsiasi tipologia di cucine componibili.



FINITURE



PLUS



ARIA PURA



ITALIAN
TECHNOLOGY



100% ECO
COMPATIBILE

CORREDO

- Piletta
- Sifone
- Ganci

INSTALLAZIONE

- Standard

ATLANTIC

CARATTERISTICHE DI PRODOTTO

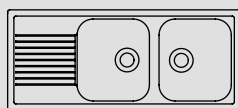

PL1162

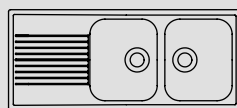

AT1162

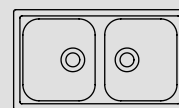

PL0862

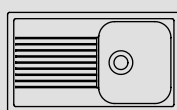

PL0861

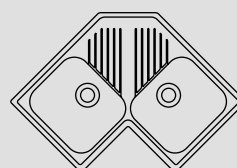

FTA8320



PL4351



ANGOLI ARROTONDATI

Gli angoli arrotondati rendono più facili le operazioni di pulizia.



STILE SENZA TEMPO

Atlantic con le sue linee semplici e funzionali si adatta a qualsiasi tipologia di cucine componibili.



ACCESSORI CONSIGLIATI

Taglieri, cestelli e vaschette aggiungono praticità e design alle funzioni di lavaggio e preparazione cibi.

MISCELATORI CONSIGLIATI



VENMIXEXT
pag. 210



SLIMFIX
pag. 211

PL1162 / ATLANTIC

Lavello a due vasche più scolapiatti - Reversibile
1160x500 mm - **Base da 90 cm**

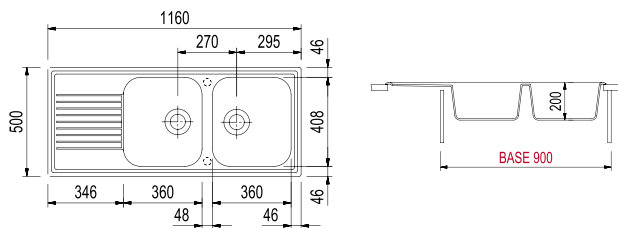

Foro per l'incasso: 1140x480 mm

ACCESSORI: 3, 4, 5, 6, 7, 8

AT1162 / ATLANTIC

Lavello a due vasche più scolapiatti - Reversibile
1160x500 mm - **Base da 80 cm**

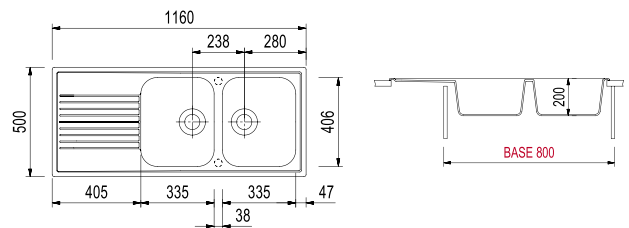

Foro per l'incasso: 1140x480 mm





ACCESSORI: 1, 2, 5, 6, 7, 8

MICROULTRAGRANIT

€ IVA esclusa

ULTRAMETAL

€ IVA esclusa

-  UG 56 JASMINE
PL1162 / 56
-  UG 70 NERO MATT
PL1162 / 70
-  UG 94 AVENA
PL1162 / 94
-  UG 98 BIANCO
PL1162 / 98



302

-  UM 41 ALLUMINIO
PL1162 / 41
-  UM 42 TITANIO
PL1162 / 42
-  UM 44 NERO
PL1162 / 44





302

MICROULTRAGRANIT

€ IVA esclusa

ULTRAMETAL

€ IVA esclusa

-  UG 56 JASMINE
AT1162 / 56
-  UG 70 NERO MATT
AT1162 / 70
-  UG 94 AVENA
AT1162 / 94
-  UG 98 BIANCO
AT1162 / 98

384

-  UM 41 ALLUMINIO
AT1162 / 41
-  UM 42 TITANIO
AT1162 / 42
-  UM 44 NERO
AT1162 / 44

410

ACCESSORI CONSIGLIATI



1_TAGL88



2_TAGP66



3_PLTAGIRK



4_PLTAGPOL



5_TAGCR



6_SPCESINX



7_ROLLUP



8_ROLLMAT

PL0862 / ATLANTIC

Lavello a due vasche
860x500 mm - Base da 90 cm

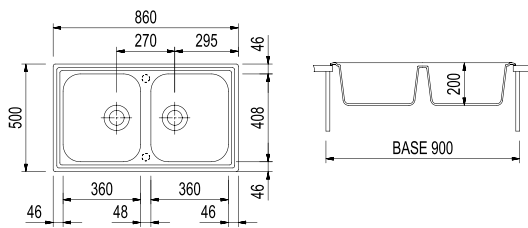





Foro per l'incasso: 840x480 mm

ACCESSORI: 3, 4, 5, 6, 7, 8

MICROULTRAGRANIT

€ IVA esclusa



-  UG 56 JASMINE
PL0862 / 56
-  UG 70 NERO MATT
PL0862 / 70
-  UG 94 AVENA
PL0862 / 94
-  UG 98 BIANCO
PL0862 / 98



296

ULTRAMETAL

€ IVA esclusa

-  UM 41 ALLUMINIO
PL0862 / 41
-  UM 42 TITANIO
PL0862 / 42
-  UM 44 NERO
PL0862 / 44



296

PL0861 / ATLANTIC

Lavello a una vasca più scolapiatti - Reversibile
860x500 mm - Base da 45 cm

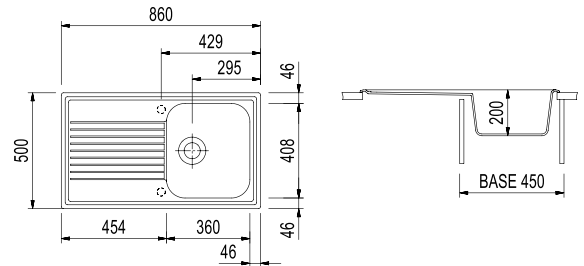





Foro per l'incasso: 840x480 mm

ACCESSORI: 3, 4, 5, 6, 7, 8

MICROULTRAGRANIT

€ IVA esclusa



-  UG 56 JASMINE
PL0861 / 56
-  UG 70 NERO MATT
PL0861 / 70
-  UG 94 AVENA
PL0861 / 94
-  UG 98 BIANCO
PL0861 / 98



284

ULTRAMETAL

€ IVA esclusa

-  UM 41 ALLUMINIO
PL0861 / 41
-  UM 42 TITANIO
PL0861 / 42
-  UM 44 NERO
PL0861 / 44



284

FTA8320 / ATLANTIC

Lavello angolare a due vasche più scolapiatti
830x500 mm - Base angolare 90x90 cm

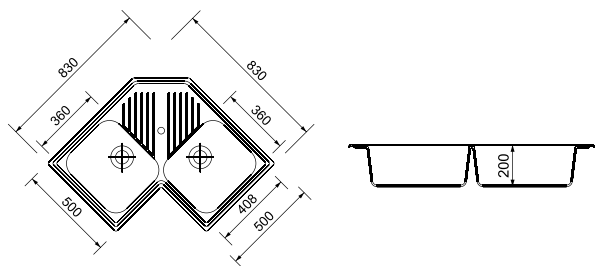

Foro per l'incasso: VEDI DIMA

ACCESSORI: 1, 2, 3, 4, 5, 6

MICROULTRAGRANIT

€ IVA esclusa

- UG 56 JASMINE
FTA8320 / 56
- UG 70 NERO MATT
FTA8320 / 70
- UG 94 AVENA
FTA8320 / 94
- UG 98 BIANCO
FTA8320 / 98

606

ULTRAMETAL

€ IVA esclusa

- UM 41 ALLUMINIO
FTA8320 / 41
- UM 42 TITANIO
FTA8320 / 42
- UM 44 NERO
FTA8320 / 44

634

PL4351 / ATLANTIC

Lavello tondo
Ø 435 mm - Base da 40/45 cm

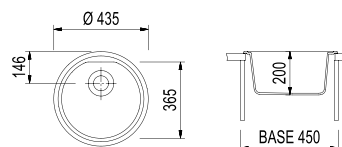

Foro per l'incasso: Ø 410 mm

ACCESSORI: /

MICROULTRAGRANIT

€ IVA esclusa

- UG 70 NERO MATT
PL4351 / 70
- UG 94 AVENA
PL4351 / 94
- UG 98 BIANCO
PL4351 / 98

320

ACCESSORI CONSIGLIATI



1_TAGL88

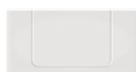

2_TAGP66



3_TAGCR



4_SPCESINX



5_ROLLUP

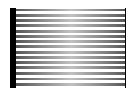

6_ROLLMAT





LAVELLI



SPAZIO

Un perfetto mix di eleganza e tradizione, il sapiente equilibrio tra forme, estetica e funzioni, rendono Spazio la linea evergreen di Plados. Il pratico gocciolatoio e il bordino perimetrale di contenimento esaltano la praticità e la funzionalità del lavello.



FINITURE



PLUS



ARIA PURA



ITALIAN
TECHNOLOGY



100% ECO
COMPATIBILE

CORREDO

- Piletta
- Sifone
- Ganci

INSTALLAZIONE

- Standard

SPAZIO

CARATTERISTICHE DI PRODOTTO

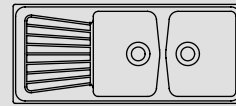

SP1162

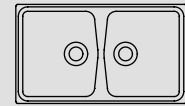

SP0862

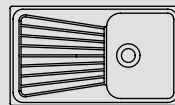

SP0861

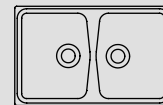

SP0792

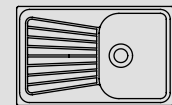

SP0791



STILE COUNTRY

Gli angoli arrotondati rendono più facili le operazioni di pulizia.



PRATICITÀ E FUNZIONALITÀ

Il pratico gocciolatoio ed il bordo perimetrale di contenimento esaltano la praticità e la funzionalità del lavello.



ACCESSORI CONSIGLIATI

TAGL88: un tagliere in legno iroko di altissima qualità, particolarmente durevole ed estremamente resistente alle escursioni termiche e all'umidità.

MISCELATORI CONSIGLIATI



TIZMIXEXT
Pag. 210



VENMIX20
pag. 213

SP1162 / SPAZIO

Lavello a due vasche più scolapiatti - Reversibile
1160x500 mm - Base da 80 cm

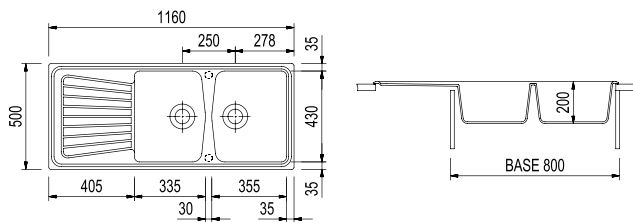





Foro per l'incasso: 1140x480 mm

ACCESSORI: 1, 2, 3, 4, 5, 6

MICROULTRAGRANIT

€ IVA esclusa

-  UG 56 JASMINE
SP1162 / 56
-  UG 70 NERO MATT
SP1162 / 70
-  UG 94 AVENA
SP1162 / 94
-  UG 98 BIANCO
SP1162 / 98



302

ULTRAQUARTZ

€ IVA esclusa

-  UQ 66 TERRA DI FRANCIA
SP1162 / 66 **328**

SP0862 / SPAZIO

Lavello a due vasche - Reversibile
860x500 mm - Base da 90 cm

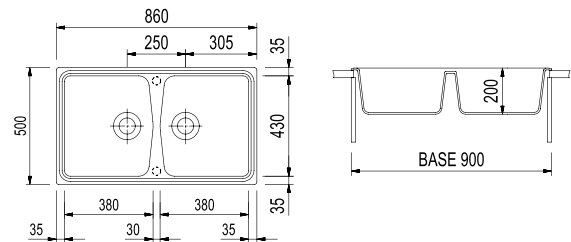





Foro per l'incasso: 840x480 mm

ACCESSORI: 1, 2, 3, 4, 5, 6

MICROULTRAGRANIT

€ IVA esclusa

-  UG 56 JASMINE
SP0862 / 56
-  UG 70 NERO MATT
SP0862 / 70
-  UG 94 AVENA
SP0862 / 94
-  UG 98 BIANCO
SP0862 / 98



296

ULTRAQUARTZ

€ IVA esclusa

-  UQ 66 TERRA DI FRANCIA
SP0862 / 66 **312**

ACCESSORI CONSIGLIATI



1_TAGL88

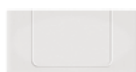

2_TAGP66

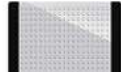

3_TAGCR



4_SPCESINX



5_ROLLUP



6_ROLLMAT

SP0861 / SPAZIO

Lavello a una vasca più scolapiatti - Reversibile
860x500 mm - Base da 45 cm

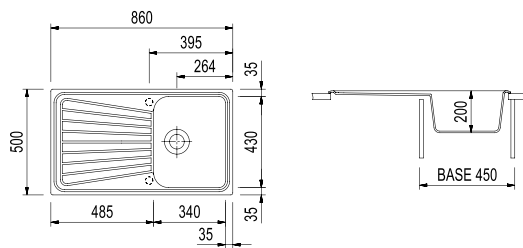





Foro per l'incasso: 840x480 mm

ACCESSORI: 1, 2, 3, 4, 5, 6

MICROULTRAGRANIT

€ IVA esclusa

-  UG 56
JASMINE
SP0861 / 56
-  UG 70
NERO MATT
SP0861 / 70
-  UG 94
AVENA
SP0861 / 94
-  UG 98
BIANCO
SP0861 / 98



284

ULTRAQUARTZ

€ IVA esclusa

-  UQ 66
TERRA DI FRANCIA
SP0861 / 66 **306**

SP0792 / SPAZIO

Lavello a due vasche
790x500 mm - Base da 80 cm

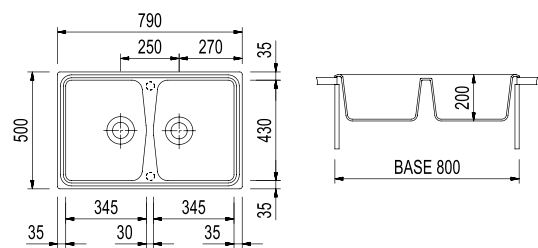





Foro per l'incasso: 770x480 mm

ACCESSORI: 1, 2, 3, 4, 5, 6

MICROULTRAGRANIT

€ IVA esclusa

-  UG 56
JASMINE
SP0792 / 56
-  UG 70
NERO MATT
SP0792 / 70
-  UG 94
AVENA
SP0792 / 94
-  UG 98
BIANCO
SP0792 / 98



296

ULTRAQUARTZ

€ IVA esclusa

-  UQ 66
TERRA DI FRANCIA
SP0792 / 66 **316**

SP0791 / SPAZIO

Lavello a una vasca più scolapiatti - Reversibile
790x500 mm - Base da 45 cm

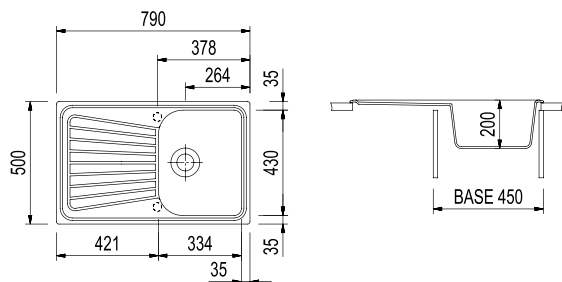

Foro per l'incasso: 770x480 mm

ACCESSORI: 1, 2, 3, 4, 5, 6

MICROULTRAGRANIT

€ IVA esclusa

- UG 56 JASMINE SP0791 / 56
- UG 70 NERO MATT SP0791 / 70
- UG 94 AVENA SP0791 / 94
- UG 98 BIANCO SP0791 / 98



284

ULTRAQUARTZ

€ IVA esclusa

- UQ 66 TERRA DI FRANCIA SP0791 / 66 310

ACCESSORI CONSIGLIATI



1_TAGL88

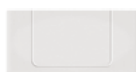

2_TAGP66



3_TAGCR



4_SPCESINX



5_ROLLUP

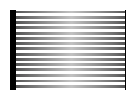

6_ROLLMAT





LAVELLI

HARMONY

Forme speciali e dimensioni particolari nei lavelli delle linee Harmony. Modelli in grado di soddisfare tutte le esigenze e le necessità da parte della Clientela, anche la più sofisticata. Estetica tradizionale che trova la naturale collocazione nelle cucine country e old style. Modelli provvisti del pratico bordino perimetrale di contenimento.





FINITURE



PLUS



ARIA PURA



ITALIAN
TECHNOLOGY



100% ECO
COMPATIBILE

CORREDO

- Piletta
- Sifone
- Ganci

INSTALLAZIONE

- Standard

HARMONY

CARATTERISTICHE DI PRODOTTO

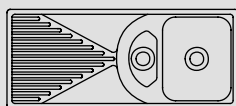

PL11610

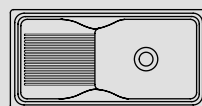

DB09910

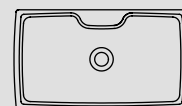

HR0860

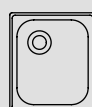

HR4321

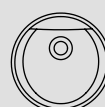

NK05110

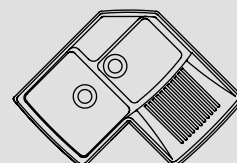

HRA832



UNA LINEA VERSATILE

I modelli HARMONY hanno dimensioni e forme particolari per soddisfare ogni necessità.



FORME TRADIZIONALI

I lavelli HARMONY trovano la loro naturale collocazione in cucine country e old-style



ACCESSORI CONSIGLIATI

Taglieri, cestelli e vaschette aggiungono praticità e design alle funzioni di lavaggio e preparazione cibi.

MISCELATORI CONSIGLIATI



EASY
pag. 212



TIZEK
pag. 212

PL11610 / HARMONY

Lavello a una vasca grande più una vasca piccola più scolapiatti
Reversibile - 1160x500 mm - Base da 60 cm



N.B. - La vasca piccola funge anche da troppopieno

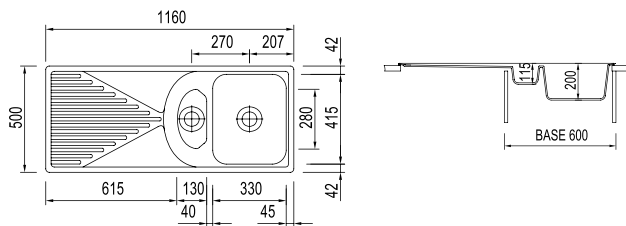



Foro per l'incasso: 1140x480 mm

ACCESSORI: 1, 3, 4, 5, 6, 7

MICROULTRAGRANIT

€ IVA esclusa

-  UG 70
NERO MATT
PL11610 / 70
-  UG 94
AVENA
PL11610 / 94
-  UG 98
BIANCO
PL11610 / 98

456

DB09910 / HARMONY

Lavello a una vasca più scolapiatti - Reversibile
990x500 mm - Base da 60-80 cm

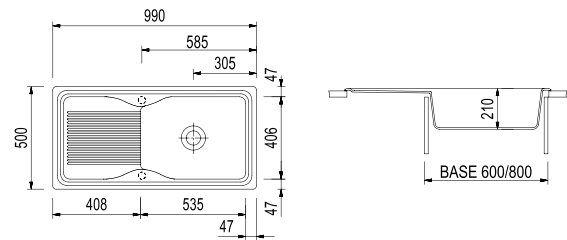





Foro per l'incasso: 970x480 mm

ACCESSORI: 1, 3, 4, 5, 6, 7

MICROULTRAGRANIT



€ IVA esclusa

-  UG 56
JASMINE
DB09910 / 56
-  UG 70
NERO MATT
DB09910 / 70
-  UG 94
AVENA
DB09910 / 94
-  UG 98
BIANCO
DB09910 / 98

460

ULTRAMETAL

€ IVA esclusa

-  UM 41
ALLUMINIO
DB09910 / 41
-  UM 42
TITANIO
DB09910 / 42
-  UM 44
NERO
DB09910 / 44

488

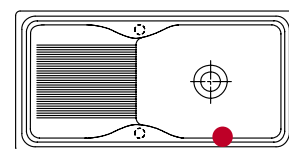

● Posizione standard del troppopieno:
Installazione su base da 60 cm (80 cm se terminale)

ACCESSORI CONSIGLIATI



1_TAGL88



2_TAGIRK1



3_TAGP66



4_TAGCR



5_SPCESINX



6_ROLLUP

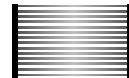

7_ROLLMAT

HR0860 / HARMONY

Lavello a una vasca
880x500 mm - Base da 90 cm

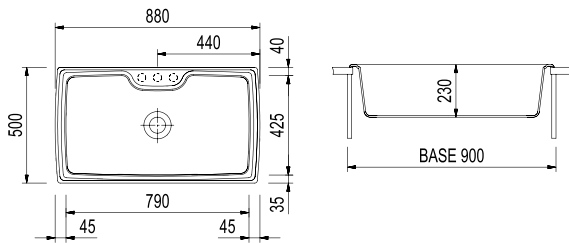





Foro per l'incasso: 840x480 mm

ACCESSORI: 2, 6, 7

MICROULTRAGRANIT



€ IVA esclusa

-  UG 56
JASMINE
HR0860 / 56
-  UG 70
NERO MATT
HR0860 / 70
-  UG 94
AVENA
HR0860 / 94
-  UG 98
BIANCO
HR0860 / 98

402

ULTRAMETAL

€ IVA esclusa

-  UM 41
ALLUMINIO
HR0860 / 41
-  UM 42
TITANIO
HR0860 / 42
-  UM 44
NERO
HR0860 / 44

428

HR4321 / HARMONY

Lavello a una vasca - Reversibile
432x500 mm - Base da 45-50 cm



Installazione standard:
Inseribile in una base da **45 cm**



Installazione longitudinale:
Inseribile in una base da **50 cm**

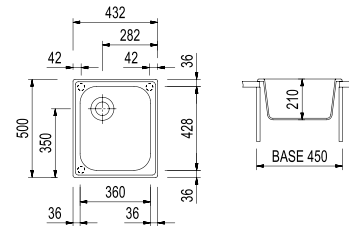





Foro per l'incasso: 410x480 mm

ACCESSORI: 1, 3, 4, 5, 6, 7

MICROULTRAGRANIT



€ IVA esclusa

-  UG 56
JASMINE
HR4321 / 56
-  UG 70
NERO MATT
HR4321 / 70
-  UG 94
AVENA
HR4321 / 94
-  UG 98
BIANCO
HR4321 / 98

360

ULTRAMETAL

€ IVA esclusa

-  UM 41
ALLUMINIO
HR4321 / 41
-  UM 42
TITANIO
HR4321 / 42
-  UM 44
NERO
HR4321 / 44

388

NK05110 / HARMONY

Lavello tondo a una vasca con banco rubinetteria
 ø 510 mm - Base da 45 cm

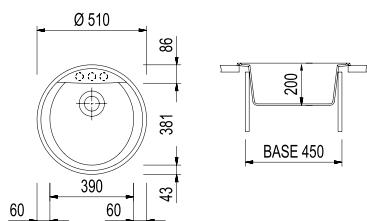



Foro per l'incasso: ø 490 mm

ACCESSORI: /

MICROULTRAGRANIT

€ IVA esclusa

-  UG 70
NERO MATT
NK05110 / 70
-  UG 94
AVENA
NK05110 / 94
-  UG 98
BIANCO
NK05110 / 98

360

HRA832 / HARMONY

Lavello angolare a due vasche più scolapiatti
 842 x 500 mm - Base angolare 90x90 cm

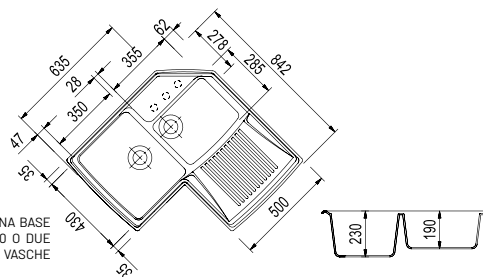





NOTA: INSERIBILE IN UNA BASE ANGOLARE DA 900X900 O DUE BASI ANGOLARI DA 900. VASCHE SOLO A SINISTRA.

Foro per l'incasso: VEDI DIMA

ACCESSORI: 1, 2, 3, 4, 5

MICROULTRAGRANIT



€ IVA esclusa

-  UG 56
JASMINE
HRA832 / 56
-  UG 70
NERO MATT
HRA832 / 70
-  UG 94
AVENA
HRA832 / 94
-  UG 98
BIANCO
HRA832 / 98

662

ULTRAMETAL

€ IVA esclusa

-  UM 41
ALLUMINIO
HRA832 / 41
-  UM 42
TITANIO
HRA832 / 42
-  UM 44
NERO
HRA832 / 44

688

ACCESSORI CONSIGLIATI



1_TAGL88

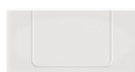

2_TAGP66



3_SPCESINX



4_ROLLUP



5_ROLLMAT

MONTAGGIO LAVELLI SOTTO-TOP

Tutti i lavelli Plados possono essere installati in maniera tradizionale, cioè incassati nel piano di lavoro della cucina; molti possono essere installati sotto-top. I disegni mostrano tre tipiche modalità d'installazione sotto-top dei lavelli Plados. **Il kit per l'installazione sotto-top è già compreso nell'imballo dei lavelli predisposti per tale installazione** (Serie ONE per installazione sotto-top). Per tutti gli altri modelli, il kit è disponibile come accessorio optional (codice **GANCIST06**).

Dal nostro sito web www.pladostelma.com, nella pagina di ogni lavello, alla voce **Downloads** possono essere scaricati i **disegni per la realizzazione dell'apertura sul piano top**. I files sono disponibili per il download in formato **DXF, DWG e PDF**.

SOLUZIONE A



I bordi del top e del lavello coincidono (Soluzione suggerita)

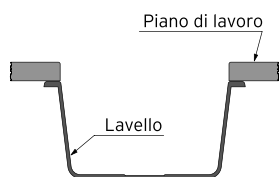

Questa soluzione:

- Esalta l'estetica.
- Facilita la pulizia;
- Ottimizza l'igiene.

SOLUZIONE B



Il top si estende oltre il bordo del lavello, su tutti i lati. Il bordo del lavello è nascosto sotto il piano top.

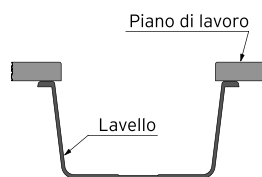
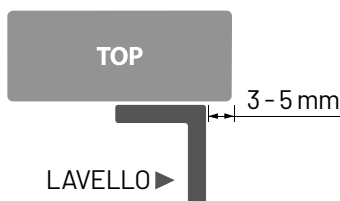

Questa soluzione:

- Semplifica l'installazione;
- Facilita la pulizia.

SOLUZIONE C



Il bordo del lavello è parzialmente visibile

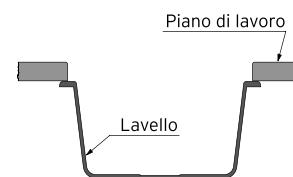
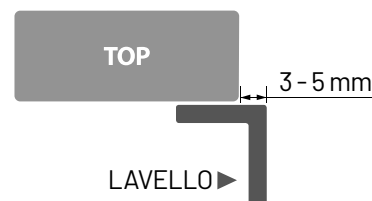

Questa soluzione:

- Facilita la pulizia;
- Ottimizza l'igiene.

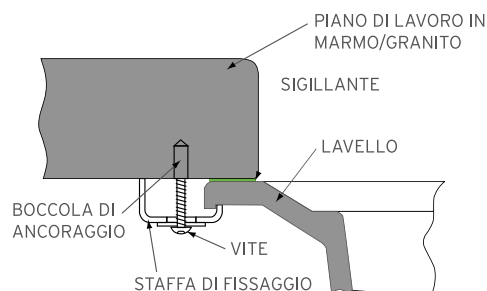
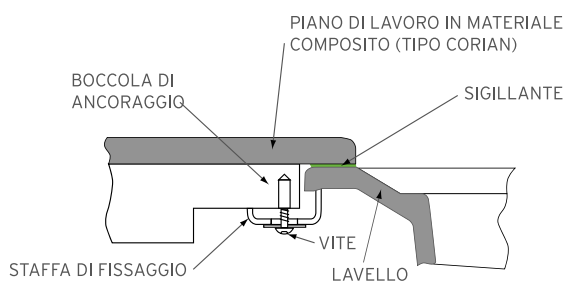



LAVELLI IN ACCIAIO INOX

La superficie completamente liscia, la raffinatezza dell'acciaio inossidabile, l'alta tecnologia impiegata nella produzione, rendono i lavelli inox Plados Telma estremamente funzionali. La cura meticolosa delle finiture e dei dettagli ci consente di raggiungere i massimi livelli di qualità e stile.

Le serie MAKI sono divise per tipologia di installazione e i lavelli sono disponibili in diverse dimensioni per soddisfare ogni esigenza di mercato; sono caratterizzati da vasche molto capienti e realizzati con il migliore acciaio inox AISI 304 18/10, che li rende completamente riciclabili, igienici e resistenti alla corrosione.

- 132 Serie **MAKI MIX-R**
con foro per miscelatore - installazione SLIM - FILOTOP
- 134 Serie **MAKI R**
senza foro per miscelatore - installazione SLIM - FILOTOP
- 136 Serie **MAKI ST-R**
senza foro per miscelatore - installazione SOTTO-TOP

- 138 Serie **OLYMPUS/VINTAGE**
- 142 Serie **UNIVERSAL**



made in italy

significa cura per i dettagli e alta qualità

VASCHE RAGGIO 12 mm

Il raggio interno dei lavelli MAKI rende ancora **più facile la pulizia**, **riduce ulteriormente il deposito di calcare** e consente una **maggiore igiene**, senza rinunciare a un **design essenziale**, moderno e minimalista.

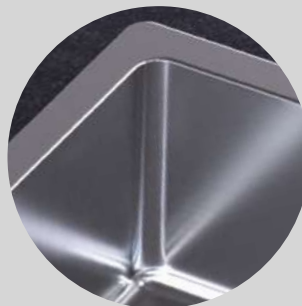

SPESSORE REGOLARE 1 mm

Rende il prodotto **ancora più robusto**, resistente e destinato a durare nel tempo. Lo spessore omogeneo è possibile grazie a un'innovativa tecnologia di lavorazione a freddo.

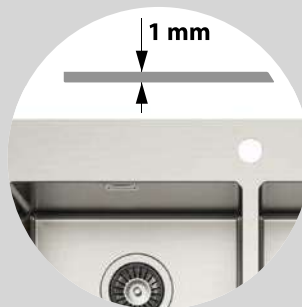

NIENTE LINEE DI DRENAGGIO VISIBILI NEL FONDO VASCA

Un nuovo sistema di deformazione consente di creare sul fondo della vasca la giusta inclinazione per far defluire l'acqua **senza che si vedano solchi o pieghe**. Il fondo appare perfettamente liscio e omogeneo e l'acqua può defluire completamente.



TROPPOPIENO DESIGN

Ogni lavello è dotato di piletta in acciaio inox AISI 304, tappo e troppopieno, per garantire il massimo livello di sicurezza. Il **raffinato troppopieno rettangolare** conferisce un valore aggiunto in termini di eleganza e design, per un prodotto di altissima qualità totalmente **MADE IN ITALY**.



Scegli il tipo di installazione, scegli la serie. Semplice!



INCASSO SLIM



MAKI MIX-R

Con banco rubinetteria



FILO-TOP



MAKI R

Senza banco rubinetteria



SOTTOTOP



MAKI ST-R

Senza banco rubinetteria

MAKI MIX-R



INCASSO SLIM



FILO-TOP



MADE IN
ITALY



100% ECO
COMPATIBILE

SR7520 / MAKI MIX-R

Lavello a due vasche - 745x510 mm - Base 80 cm

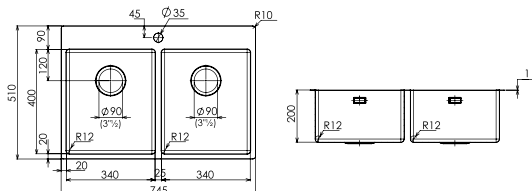

Foro per l'incasso: 735x495 mm

ACCESSORI: 1, 2, 3, 4, 5, 6, 7

€ IVA
esclusa



ACCIAIO SATINATO
SR7520

838

SR7500 / MAKI MIX-R

Lavello a una vasca - 740x510 mm - Base 80 cm

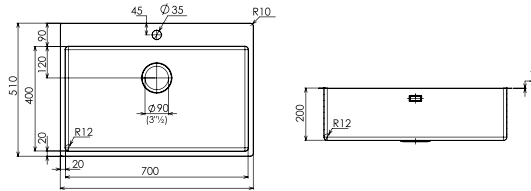

Foro per l'incasso: 730x495 mm

ACCESSORI: 1, 2, 3, 4, 5, 6, 7

€ IVA
esclusa



ACCIAIO SATINATO
SR7500

648

SR5500 / MAKI MIX-R

Lavello a una vasca - 540x510 mm - Base 60 cm

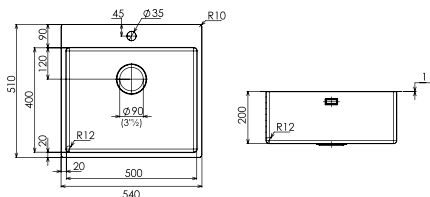

Foro per l'incasso: 530x495 mm

ACCESSORI: 1, 2, 3, 4, 5, 6, 7

€ IVA
esclusa



ACCIAIO SATINATO
SR5500

566

SR3900 / MAKI MIX-R

Lavello a una vasca - 380x510 mm - Base 45 cm

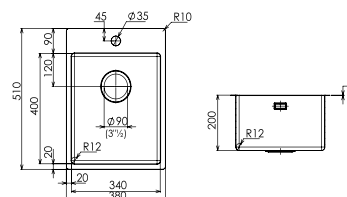

Foro per l'incasso: 370x495 mm

ACCESSORI: 1, 2, 3, 4, 5, 6, 7

€ IVA
esclusa



ACCIAIO SATINATO
SR3900

510

ACCESSORI CONSIGLIATI



1_COPHPLON



2_TAGL88



3_TAGP66



4_ONTAGCR



5_SPCESINX



6_ROLLUP



7_ROLLMAT

MAKI R



INCASSO SLIM



FILO-TOP



MADE IN
ITALY



100% ECO
COMPATIBILE

MR7420 / MAKI R

Lavello a due vasche - 745x440 mm - Base 80 cm

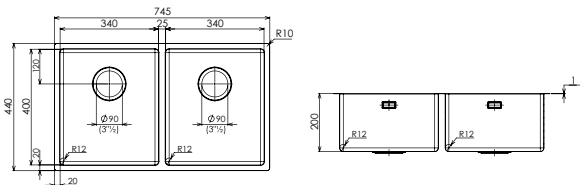

Foro per l'incasso: 735x430 mm

ACCESSORI: 1, 2, 3, 4, 5, 6, 7

€ IVA
esclusa



ACCIAIO SATINATO
MR7420 **730**

MR7400 / MAKI R

Lavello a una vasca - 740x440 mm - Base 80 cm

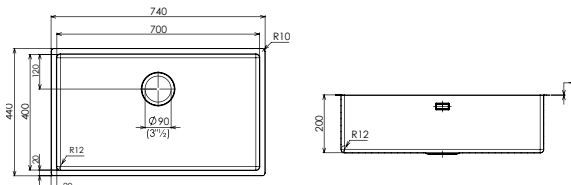

Foro per l'incasso: 730x430 mm

ACCESSORI: 1, 2, 3, 4, 5, 6, 7

€ IVA
esclusa



ACCIAIO SATINATO
MR7400 **470**

MR5400 / MAKI R

Lavello a una vasca - 540x440 mm - Base 60 cm

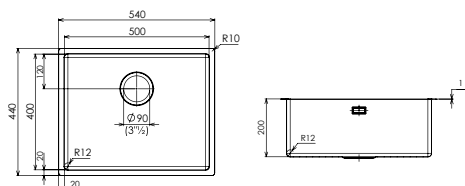

Foro per l'incasso: 530x430 mm

ACCESSORI: 1, 2, 3, 4, 5, 6, 7

€ IVA
esclusa



ACCIAIO SATINATO
MR5400 **398**

MR3800 / MAKI R

Lavello a una vasca - 380x440 mm - Base 45 cm

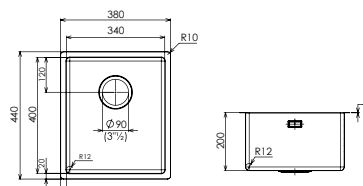

Foro per l'incasso: 370x430 mm

ACCESSORI: 1, 2, 3, 4, 5, 6, 7

€ IVA
esclusa



ACCIAIO SATINATO
MR3800 **356**

ACCESSORI CONSIGLIATI



1_COPHPLON



2_TAGL88



3_TAGP66



4_ONTAGCR



5_SPCESINX



6_ROLLUP



7_ROLLMAT

MAKI ST-R



**INSTALLAZIONE
SOTTO-TOP**



**MADE IN
ITALY**



**100% ECO
COMPATIBILE**

SL7420 / MAKI ST-R

Lavello a due vasche - 745x440 mm - Base 80 cm

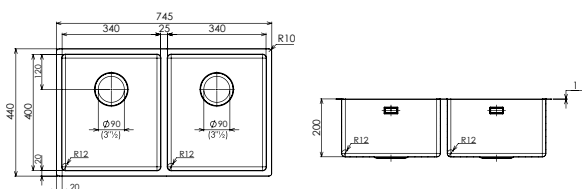

Foro per l'incasso: 705x400 mm

ACCESSORI: 1, 2, 3, 4, 5, 6, 7

€ IVA esclusa



ACCIAIO SATINATO
SL7420

684

SL7400 / MAKI ST-R

Lavello a una vasca - 740x440 mm - Base 80 cm

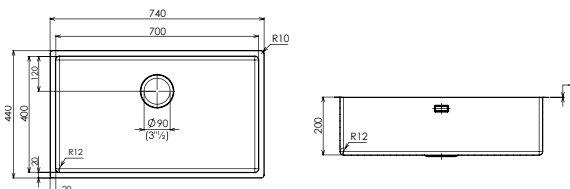

Foro per l'incasso: 700x400 mm

ACCESSORI: 1, 2, 3, 4, 5, 6, 7

€ IVA esclusa



ACCIAIO SATINATO
SL7400

428

SL5400 / MAKI ST-R

Lavello a una vasca - 540x440 mm - Base 60 cm

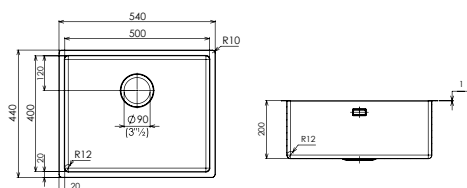

Foro per l'incasso: 500x400 mm

ACCESSORI: 1, 2, 3, 4, 5, 6, 7

€ IVA esclusa



ACCIAIO SATINATO
SL5400

356

SL3800 / MAKI ST-R

Lavello a una vasca - 380x440 mm - Base 45 cm

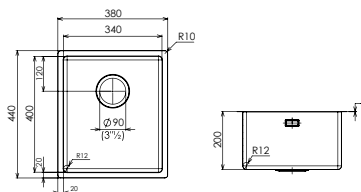

Foro per l'incasso: 340x400 mm

ACCESSORI: 1, 2, 3, 4, 5, 6, 7

€ IVA esclusa



ACCIAIO SATINATO
SL3800

316

ACCESSORI CONSIGLIATI



1_COPHPLON



2_TAGL88



3_TAGP66



4_ONTAGCR



5_SPCESINX



6_ROLLUP



7_ROLLMAT

LAVELLI



OLYMPUS/VINTAGE

Le linee tradizionali e la forza dell'acciaio inossidabile fanno di OLYMPUS una linea versatile, con un caratteristico gocciolatoio che si adatta ad ambienti classici e moderni.

VINTAGE raggruppa modelli dalle forme particolari, adatti a soddisfare ogni esigenza del mercato.



ITALIAN
TECHNOLOGY



100% ECO
COMPATIBILE

CO1162_ / OLYMPUS

Lavello a due vasche più scolapiatti - 1160x500 mm - Base 80 cm

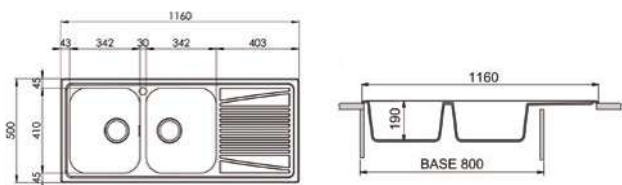

Foro per l'incasso: 1135x475 mm

ACCESSORI: 1, 2, 3, 4, 5

€ IVA esclusa



CO11621
Scolapiatti a destra

334

ACCIAIO SATINATO

CO11622
Scolapiatti a sinistra

VI1001_ / OLYMPUS

Lavello a una vasca più scolapiatti - 1000x500 mm - Base 60/80 cm

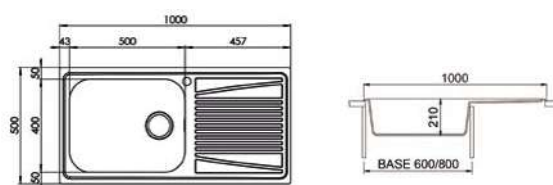

Foro per l'incasso: 975x475 mm

ACCESSORI: 1, 2, 3, 4, 5

€ IVA esclusa



VI10011
Scolapiatti a destra

366

ACCIAIO SATINATO

VI10012
Scolapiatti a sinistra

CO08620 / OLYMPUS

Lavello a due vasche - 860x500 mm - Base 90 cm

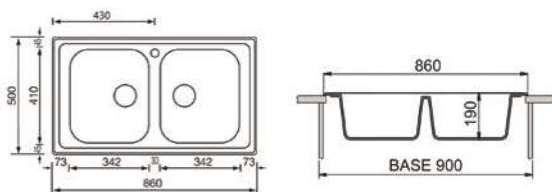

Foro per l'incasso: 835x475 mm

ACCESSORI: 1, 2, 3, 4, 5

€ IVA esclusa



ACCIAIO SATINATO
CO08620

310

CO0861_ / OLYMPUS

Lavello a una vasca più scolapiatti - 860x500 mm - Base 45 cm

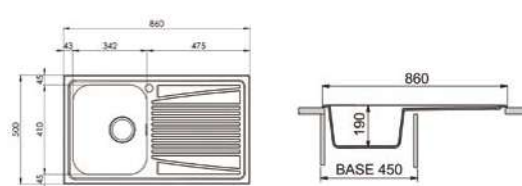

Foro per l'incasso: 835x475 mm

ACCESSORI: 1, 2, 3, 4, 5

€ IVA esclusa



CO08611
Scolapiatti a destra

252

ACCIAIO SATINATO

CO08612
Scolapiatti a sinistra

ACCESSORI CONSIGLIATI



1_TAGL88

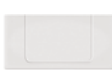

2_TAGP66



3_SPCESINX



4_ROLLUP



5_ROLLMAT

C007920 / OLYMPUS

Lavello a due vasche - 790x500 mm - Base 80 cm

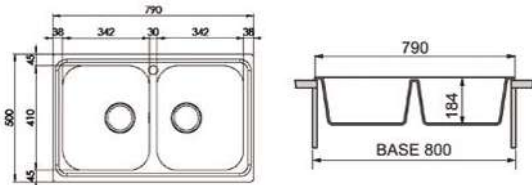

Foro per l'incasso: 775x480 mm

ACCESSORI: 1, 2, 3, 4, 5

€ IVA
esclusa



ACCIAIO SATINATO
C007920 **310**

C00791_ / OLYMPUS

Lavello a una vasca più scolapiatti - 790x500 mm - Base 45 cm

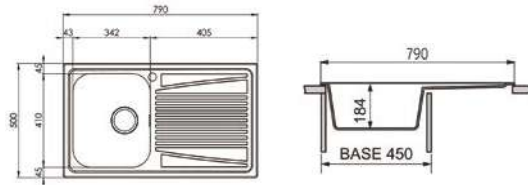

Foro per l'incasso: 775x480 mm

ACCESSORI: 1, 2, 3, 4, 5

€ IVA
esclusa



C007911
Scolapiatti a destra

252



ACCIAIO SATINATO
C007912
Scolapiatti a sinistra

VI08600 / VINTAGE

Lavello a una vasca - 860x510 mm - Base 80 cm

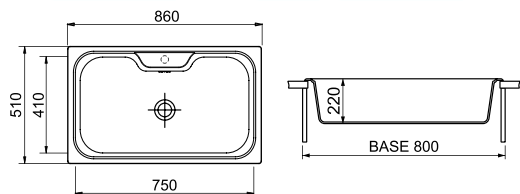

Foro per l'incasso: 840x490 mm

ACCESSORI: 1, 2, 3, 4, 5

€ IVA
esclusa



ACCIAIO SATINATO
VI08600 **548**

LISP000431S / VINTAGE

Lavello tondo - ø 435 mm - Base 45 cm

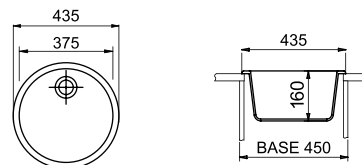

Foro per l'incasso: ø 410 mm

ACCESSORI: /

€ IVA
esclusa



ACCIAIO SATINATO
LISP000431S **170**

ACCESSORI CONSIGLIATI



1_TAGL88

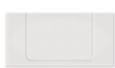

2_TAGP66



3_SPCESINX



4_ROLLUP



5_ROLLMAT

LISP838320S / VINTAGE

Lavello angolare a due vasche più scolapiatti
830x500 mm - Base angolare 90x90 cm

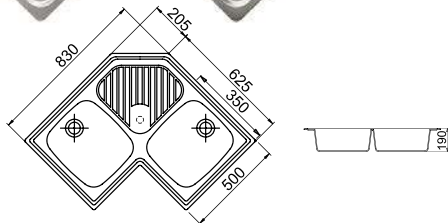

Foro per l'incasso: VEDI DIMA

ACCESSORI: 1, 2, 3, 4, 5

€ IVA
esclusa



ACCIAIO SATINATO
LISP838320S

648

VIA832_ / VINTAGE

Lavello angolare a due vasche più scolapiatti
830x500 mm - Base angolare 90x90 cm

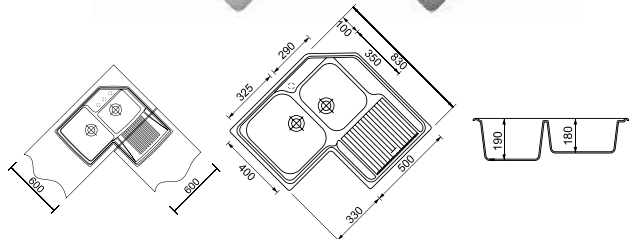

Foro per l'incasso: VEDI DIMA

ACCESSORI: 1, 2, 3, 4, 5

€ IVA
esclusa



VIA8321
Scolapiatti a destra

794

ACCIAIO SATINATO
VIA8322
Scolapiatti a sinistra

LISP504410S60 / VINTAGE

Lavello a una vasca - 440x500 mm - Base 45 cm

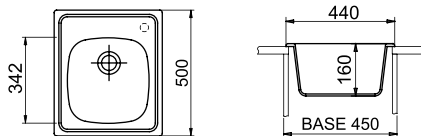

Foro per l'incasso: 415x475 mm

ACCESSORI: 1, 2, 4, 5

€ IVA
esclusa



ACCIAIO SATINATO
LISP504410S60

162

LAVELLI



UNIVERSAL

Universal è la linea dalle forme tradizionali
che unisce semplicità e convenienza.



ITALIAN
TECHNOLOGY



100% ECO
COMPATIBILE

TL1162_ / UNIVERSAL

Lavello a due vasche più scolapiatti - 1160x500 mm - Base 80 cm

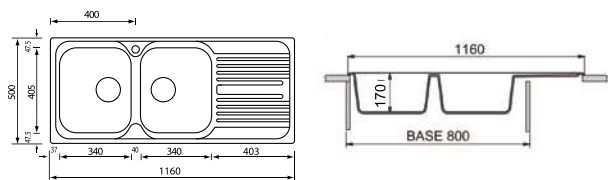

Foro per l'incasso: 1135x475 mm

ACCESSORI: 1, 2, 3, 4, 5

€ IVA esclusa



ACCIAIO SATINATO

TL11621

Scolapiatti a destra

274

TL11622

Scolapiatti a sinistra

TL08620 / UNIVERSAL

Lavello a due vasche - 860x500 mm - Base 90 cm

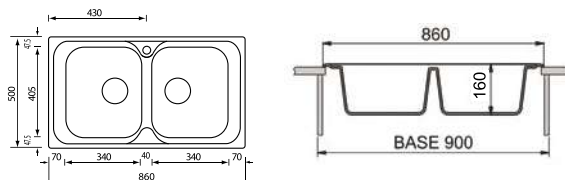

Foro per l'incasso: 835x475 mm

ACCESSORI: 1, 2, 3, 4, 5

€ IVA esclusa



ACCIAIO SATINATO
TL08620

234

TL0861_ / UNIVERSAL

Lavello a una vasca più scolapiatti
860x500 mm - Base 45 cm

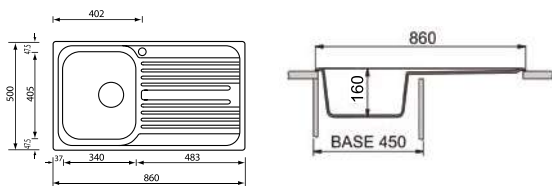

Foro per l'incasso: 835x475 mm

ACCESSORI: 1, 2, 3, 4, 5

€ IVA esclusa



ACCIAIO SATINATO

TL08611

Scolapiatti a destra

210

TL08612

Scolapiatti a sinistra

ACCESSORI CONSIGLIATI



1_TAGL88

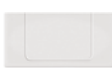

2_TAGP66



3_SPCESINX



4_ROLLUP



5_ROLLMAT





COPRIVASCA IN HPL	166
ACCESSORI COORDINATI	167
ACCESSORI DESIGN	173
TAGLIERI	174
VASCHETTE	176
TRITARIFIUTI	177
MANUTENZIONE E PULIZIA	178
ALTRI ACCESSORI	179

**PLADOS
TELMA**

GLI ACCESSORI CHE FANNO LA DIFFERENZA



ROLLMAT

Un gocciolatoio pieghevole con barre a sezione rettangolare, per una maggiore stabilità. Disponibile in 4 colori.



COPRI VASCA

Una pratica superficie aggiuntiva, utile durante la preparazione dei cibi, ideale per i lavelli sprovvisti di gocciolatoio.



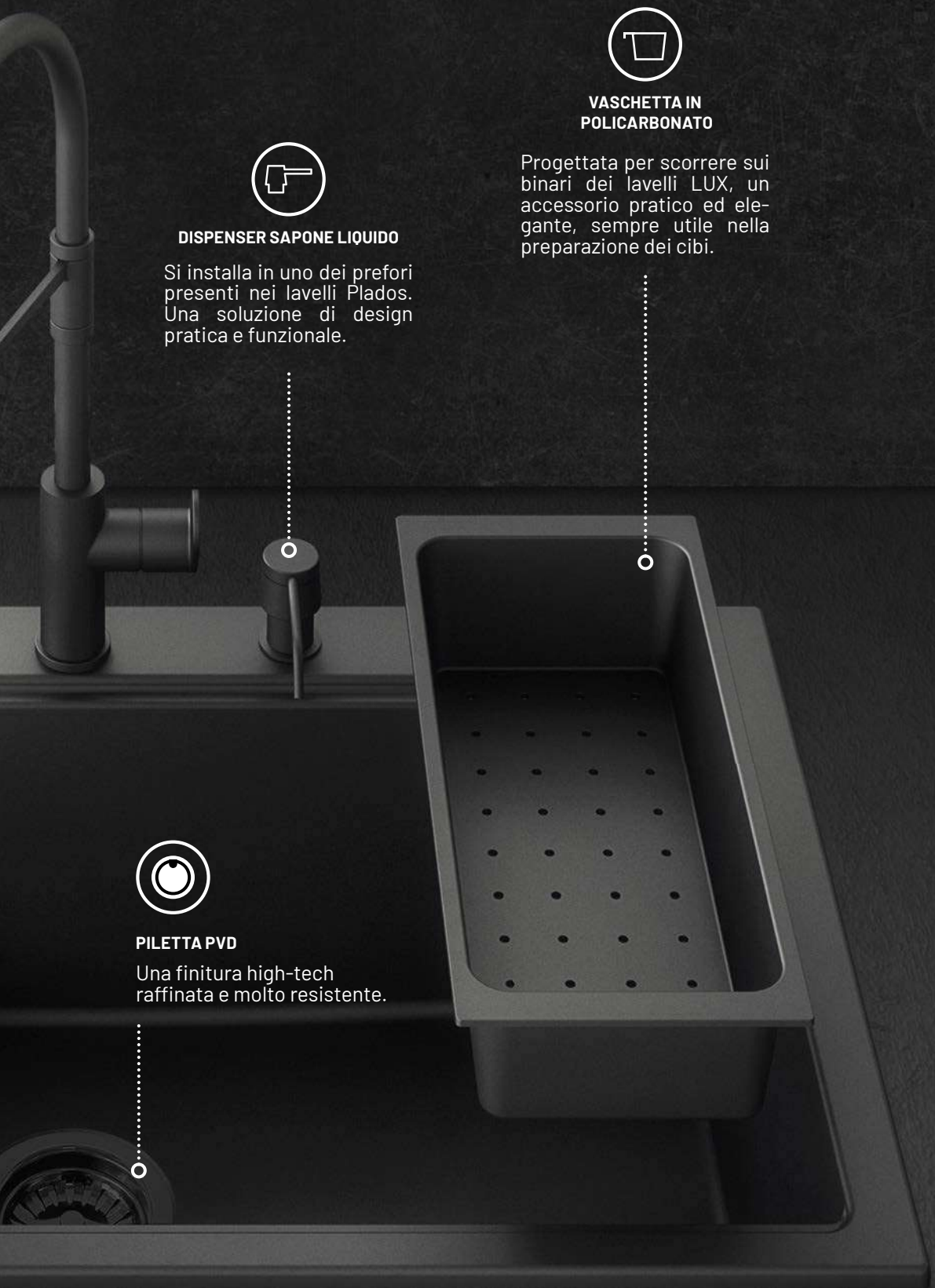

DISPENSER SAPONE LIQUIDO

Si installa in uno dei prefori presenti nei lavelli Plados. Una soluzione di design pratica e funzionale.



VASCHETTA IN POLICARBONATO

Progettata per scorrere sui binari dei lavelli LUX, un accessorio pratico ed elegante, sempre utile nella preparazione dei cibi.



PILETTA PVD

Una finitura high-tech raffinata e molto resistente.

COPRIVASCA

IN HPL



FINITURE DISPONIBILI:



TORTORA



CEMENTO



ARDESIA



CODICE	MISURA	DESCRIZIONE	COLORI DISPONIBILI	€ iva esclusa
COPHPLON	414X250	Coprivasca per serie ONE inclusi i modelli sotto-top ed integrati. Per AM8620 incluse le versioni sotto-top e integrata.	- CPHPLON/TOR - CPHPLON/CEM - CPHPLON/ARD	€ 110



CODICE	MISURA	DESCRIZIONE	COLORI DISPONIBILI	€ iva esclusa
COPHPLX1	423X280	Coprivasca a scorrimento interno per CT9010	- CPHPLX1/TOR - CPHPLX1/CEM - CPHPLX1/ARD	€ 104



CODICE	MISURA	DESCRIZIONE	COLORI DISPONIBILI	€ iva esclusa
COPHPLX2	405X430	Coprivasca a scorrimento interno per modello LX8610 e LX8620 ATTENZIONE! Il codice CPHPLX2... si riferisce al singolo coprivasca e non alla coppia.	- CPHPLX2/TOR - CPHPLX2/CEM - CPHPLX2/ARD	€ 116

ACCESSORI COORDINATI - CANNA DI FUCILE



NEW

CODICE	MISURA	DESCRIZIONE	€ iva esclusa
KITPVD1	ø 90 mm	Piletta a una via, 1 griglia troppopieno rettangolare, 1 griglia troppopieno rotonda, in PVD Gun Metal. Può essere richiesto anche successivamente all'ordine del lavello. Compatibile con tutte le pilette standard da 3,5"	 68



NEW

CODICE	MISURA	DESCRIZIONE	€ iva esclusa
KITPVD2	ø 90 mm	Piletta a due vie, 1 griglia troppopieno rettangolare, 1 griglia troppopieno rotonda, in PVD Gun Metal. Può essere richiesto anche successivamente all'ordine del lavello. Compatibile con tutte le pilette standard da 3,5"	 112

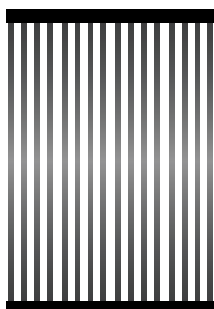

CODICE	MISURA	DESCRIZIONE	€ iva esclusa
ROLLMAT-BL	442X316	Gocciolatoio pieghevole in silicone e acciaio inox, in PVD Gun Metal	 104

ACCESSORI COORDINATI - ORO



MISCELATORE CONSIGLIATO:
Mod. NEMO, finitura PVD Oro



NEW

CODICE	MISURA	DESCRIZIONE	€ iva esclusa
KITPVD1G	ø 90 mm	Piletta a una via, 1 griglia troppopieno rettangolare, 1 griglia troppopieno rotonda, in PVD color oro. Può essere richiesto anche successivamente all'ordine del lavello. Compatibile con tutte le pilette standard da 3,5"	 68



NEW

CODICE	MISURA	DESCRIZIONE	€ iva esclusa
KITPVD2G	ø 90 mm	Piletta a due vie, 1 griglia troppopieno rettangolare, 1 griglia troppopieno rotonda, in PVD color oro. Può essere richiesto anche successivamente all'ordine del lavello. Compatibile con tutte le pilette standard da 3,5"	 112

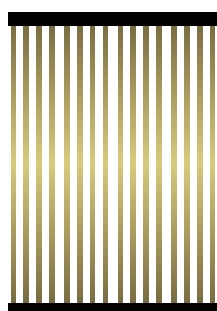

CODICE	MISURA	DESCRIZIONE	€ iva esclusa
ROLLMAT-GO	442X316	Gocciolatoio pieghevole in silicone e acciaio inox, color oro (GOLD)	 104

ACCESSORI COORDINATI - RAME



MISCELATORE CONSIGLIATO:
Mod. NEMO, finitura PVD Rame



NEW

CODICE	MISURA	DESCRIZIONE	€ iva esclusa
KITPVD1C	ø 90 mm	Piletta a una via, 1 griglia troppopieno rettangolare, 1 griglia troppopieno rotonda, in PVD color rame. Può essere richiesto anche successivamente all'ordine del lavello. Compatibile con tutte le pilette standard da 3,5"	 68



NEW

CODICE	MISURA	DESCRIZIONE	€ iva esclusa
KITPVD2C	ø 90 mm	Piletta a due vie, 1 griglia troppopieno rettangolare, 1 griglia troppopieno rotonda, in PVD color rame. Può essere richiesto anche successivamente all'ordine del lavello. Compatibile con tutte le pilette standard da 3,5"	 112

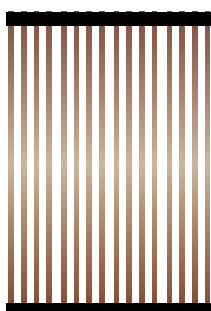

CODICE	MISURA	DESCRIZIONE	€ iva esclusa
ROLLMAT-CO	442X316	Gocciolatoio pieghevole in silicone e acciaio inox, color rame (COPPER)	 104



PLADOS
TELMA

PLADOS TELMA

ACCESSORI COORDINATI - TOTAL BLACK



MISCELATORE CONSIGLIATO:
Mod. NEMO, finitura N6 Deep Black



CODICE	MISURA	DESCRIZIONE	€ iva esclusa
KITBLACK1	ø 90 mm	Kit composto da piattino copri-piletta e piletta, troppopieno rotondo e rettangolare, in ABS nero. Può essere richiesto anche successivamente all'ordine del lavello. Compatibile con tutte le pilette di scarico standard da 3,5".	 100



CODICE	MISURA	DESCRIZIONE	€ iva esclusa
KITBLACK2	ø 90 mm	Kit composto da piattino copri-piletta e piletta, troppopieno rotondo e rettangolare, in ABS nero. Può essere richiesto anche successivamente all'ordine del lavello. Compatibile con tutte le pilette di scarico standard da 3,5".	 146

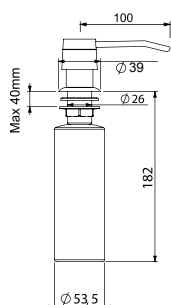

CODICE	MISURA	DESCRIZIONE	COLORI DISPONIBILI	€ iva esclusa
DISP-70	ø 26 mm	Dispenser per sapone liquido. Per tutti i modelli dove è possibile l'inserimento. Vedi prefori sotto il lavello.	• DISP/70 Nero Matt	72

ROLLMAT

Il gocciolatoio pieghevole ROLLMAT è dotato di barre in acciaio inox a sezione quadrata per garantire una maggiore stabilità agli oggetti che vi poggiano. Può essere utilizzato anche piegato, riducendo così l'ingombro e aumentando la stabilità. Adatto per modelli da incasso e sottotop, ROLLMAT è disponibile in 4 raffinati colori per abbinarsi nel modo migliore allo stile della cucina:

- Inox
- Black
- Copper
- Gold

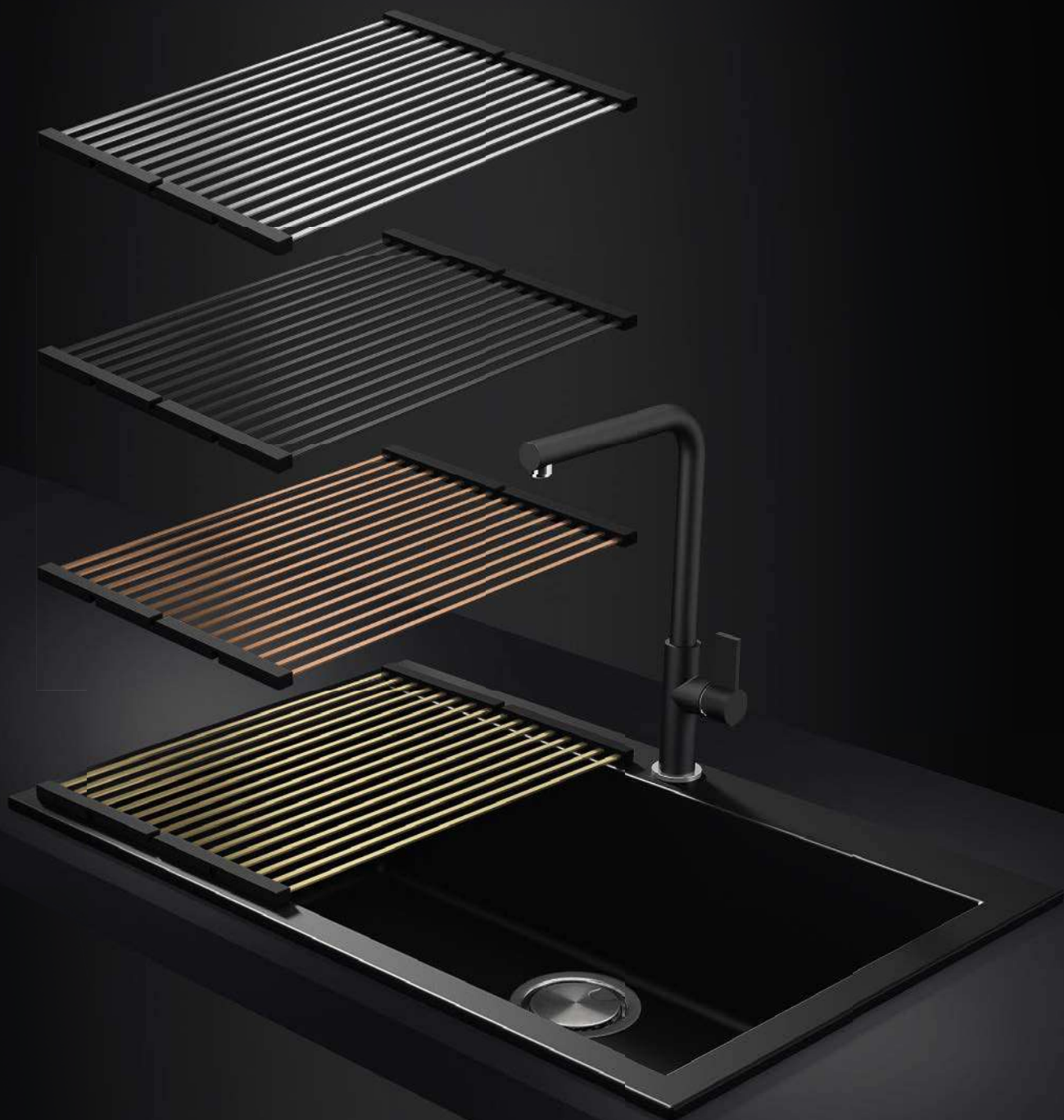

ACCESSORI DESIGN

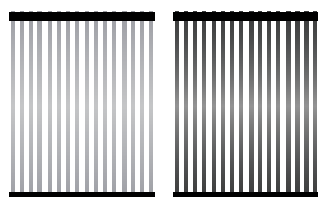

INOX

GUN METAL

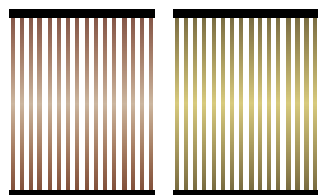

COPPER

GOLD



Pieghevole

CODICE	MISURA	DESCRIZIONE	€ iva esclusa
ROLLMAT	442X316	Gocciolatoio pieghevole in silicone e acciaio inox, universale. Colori disponibili: <ul style="list-style-type: none"> • IX - Inox • BL - Gun Metal • CO - Copper • GO - Gold 	 104

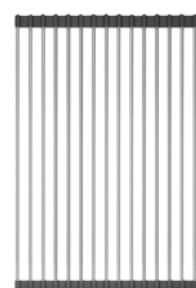

Avvolgibile

CODICE	MISURA	DESCRIZIONE	€ iva esclusa
ROLLUP	315X454	Gocciolatoio avvolgibile in silicone e acciaio inox, universale.	 80

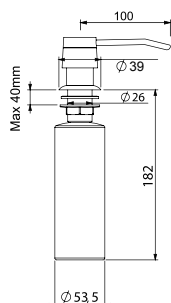

CODICE	MISURA	DESCRIZIONE	COLORI DISPONIBILI	€ iva esclusa
DISP	ø 26 mm	Dispenser per sapone liquido. Per tutti i modelli dove è possibile l'inserimento. Vedi prefori sotto il lavello.	• DISP/40 Cromo	48
			• DISP/70 Nero Matt	72



CODICE	MISURA	DESCRIZIONE	€ iva esclusa
COVERIX	ø 90 mm	Piattino copri-piletta in acciaio inox con finitura satinata. La piletta standard in acciaio inox è inclusa in ogni lavello. Può essere richiesto anche successivamente all'ordine del lavello. Compatibile con tutte le pilette di scarico standard da 3,5".	 18



CODICE	MISURA	DESCRIZIONE	€ iva esclusa
COPPILTIO	ø 90 mm	Kit composto da un cestello più un copri-piletta. Può essere richiesto anche successivamente all'ordine del lavello. Compatibile con tutte le pilette di scarico standard da 3,5".	 24



CODICE	MISURA	DESCRIZIONE	€ iva esclusa
CTPC10P		Clip removibile copri-troppo pieno. Non impedisce il deflusso. Compatibile con il troppo pieno rotondo standard.	 18

TAGLIERI

IN LEGNO IROKO



CODICE	MISURA	DESCRIZIONE	€ iva esclusa
MULTIRACK	423X200	Piano ausiliario scorrevole con due contenitori in acciaio inox per posate o utensili. Per CT9010.	120



CODICE	MISURA	DESCRIZIONE	€ iva esclusa
TAGL88	534X280	Tagliere universale a scorrimento esterno, per tutti i lavelli rettangolari eccetto serie ONE sotto-top e serie ONE integrata.	102



CODICE	MISURA	DESCRIZIONE	€ iva esclusa
PLTAGIRK	425X376	Per modelli ATLANTIC PL1162, PL0862, PL0861.	102



CODICE	MISURA	DESCRIZIONE	€ iva esclusa
TAGL44	413X250	Per modello ELEGANCE AM8620 e per serie ONE eccetto ON8620	102



CODICE	MISURA	DESCRIZIONE	€ iva esclusa
TAGIRK1	467X439	Per modello HR0860	102

TAGLIERI

IN POLIETILENE E CRISTALLO

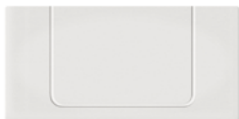

CODICE	MISURA	DESCRIZIONE	€ iva esclusa
TAGP66	534X260	Tagliere universale a scorrimento esterno, per tutti i livelli rettangolari eccetto serie ONE sotto-top e serie ONE integrata.	102



CODICE	MISURA	DESCRIZIONE	€ iva esclusa
PLTAGPOL	425X376	Per modelli ATLANTIC PL1162, PL0862, PL0861.	102

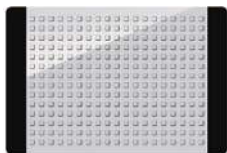

CODICE	MISURA	DESCRIZIONE	€ iva esclusa
TAGCR	479X271	Tagliere in cristallo trasparente con serigrafia sul lato posteriore. Per tutti i modelli rettangolari eccetto HR0860, HR0862, HR0792, Serie Roxana, Serie ONE.	70



CODICE	MISURA	DESCRIZIONE	€ iva esclusa
ONTAGCR	412X270	Tagliere in cristallo, smerigliato sul lato posteriore. Per serie ONE eccetto ON8420, ON8410, ON8620, ON8420ST, ON8410ST, ON8620ST.	88



CODICE	MISURA	DESCRIZIONE	€ iva esclusa
TAGCRLUX	405X430	Tagliere in cristallo per LX8620	



- Colori disponibili:
- TAGCRLUX/K1 - Cristallo Bianco **88**
 - TAGCRLUX/K2 - Cristallo Nero **88**

ATTENZIONE! Il codice TAGCRLUX... si riferisce al singolo tagliere in cristallo e non alla coppia.

VASCHEE E CESTELLI

IN ACCIAIO INOX E POLICARBONATO





CODICE	MISURA	DESCRIZIONE	€ iva esclusa
LXVASINX	392X169	Vaschetta in acciaio inox per modello LX8620	 130
ONVASINX	424x167	Vaschetta in acciaio inox per AM8620, e per le serie ONE eccetto ON8620.	 130



CODICE	MISURA	DESCRIZIONE	€ iva esclusa
SPCESINX	385X315	Cestello rettangolare per tutti modelli eccetto HR0860 e lavelli tondi.	114



CODICE	MISURA	DESCRIZIONE	€ iva esclusa
VAS70LX	401x180	Vaschetta in policarbonato nero per LX8620 e LX8610.	 70
VAS700N	423X180	Vaschetta in policarbonato nero per LX8410, ON7610, ON7920, ON6910, ON6010, ON5610 AM8620, e relative versioni sottotop.	 70



CODICE	MISURA	DESCRIZIONE	€ iva esclusa
SPVASPOL	297x160	Vaschetta in policarbonato trasparente per i modelli: Elegance AM7815 Corax CX0991;	32

TRITARIFIUTI

I DISSIPATORI PLADOS ELIMINANO I RIFIUTI ALIMENTARI IN MODO COMODO, PRATICO E SICURO.

I rifiuti depositati in pattumiera causano spesso disordine, sporcizia e cattivi odori, attirando talvolta fastidiosi insetti. L'utilizzo del tritarifiuti consente di eliminare questo genere di inconvenienti facilitando il lavoro domestico. Un aiuto indispensabile per mantenere ordine ed igiene in cucina.

RIFIUTI ALIMENTARI SMALTIBILI: frutta, verdura, lische di pesce, piccole ossa, pasta, gusci d'uovo, noci, etc...



**PULSANTE IN ABS
CROMATO DI SERIE**



TBG05

- 1/2 HP
- 380 W
- 220-240 V / 50 Hz
- Isolamento acustico standard
- Peso kg 6,5
- Dimensioni 182x327 mm
- Capacità ml 1.200
- Motore ad induzione

€ iva esclusa

520



**PULSANTE IN ABS
CROMATO DI SERIE**



TBG075

- 3/4 HP
- 600 W
- 220-240 V / 50 Hz
- Isolamento acustico **plus**
- Peso kg 8,5
- Dimensioni 182x327 mm
- Capacità ml 1.200
- Motore ad induzione
- **Doppio sistema di triturazione**
- **Rotore maggiorato**

€ iva esclusa

794

MANUTENZIONE

E PULIZIA



BRILLCARE

500 ml - BRILLCARE è un detergente a base d'acqua, formulato con agenti di **derivazione vegetale velocemente biodegradabili**, riconosciuti e certificati **ECOLABEL**. È ideale per la pulizia quotidiana dei **lavelli e di tutte le superfici lavabili della cucina**. BRILLCARE rispetta le superfici e non lascia aloni.

€ iva esclusa

38



EXTRACARE

500 ml - EXTRACARE è un detergente smacchiante per le pulizie straordinarie. Attivo contro lo sporco più ostinato, è stato studiato **per smacchiare senza danneggiare il colore e la lucentezza dei lavelli in materiale composito**. Grazie alla sua formulazione densa è indicato anche per l'applicazione in verticale. La lenta asciugatura permette agli agenti attivi di reagire per il maggior tempo possibile. È molto facile da applicare e non lascia aloni. L'ideale è utilizzare Extracare dopo aver eliminato il calcare con DeKal.

€ iva esclusa

38



MULTICARE

250 ml - MULTICARE è un detergente multisuperficie. Formulato con agenti di derivazione vegetale velocemente biodegradabili, riconosciuti e certificati **ECOLABEL**, è ideale **per la pulizia di lavelli in acciaio inox, rubinetti colorati e piani cottura smaltati**. MULTICARE rispetta le superfici e non lascia aloni.

€ iva esclusa

36



DEKAL

250 ml - DEKAL è un anticalcare studiato per i lavelli Plados che **elimina il calcare senza danneggiare la lucentezza del materiale composito**. Sugeriamo di effettuare la decalcificazione una volta a settimana. In caso di macchie ostinate, dopo aver eliminato il calcare con DEKAL, si può utilizzare lo smacchiatore EXTRACARE.

€ iva esclusa

46



ECOSPONGE

Due spugne doppia azione in cellulosa di origine vegetale e **100% biodegradabile**. Il lato in cellulosa di origine vegetale è super assorbente, ideale **per pulire con delicatezza**, mentre il lato in fibra **pulisce le superfici incrostate senza graffiare**. I lati rinforzati garantiscono lunga durata e l'alto spessore un'efficace protezione delle dita. Multiuso, ideale per tutti i prodotti Plados in cucina.

€ iva esclusa

26

ALTRI ACCESSORI



CODICE	MISURA	DESCRIZIONE	€ iva esclusa
PILAV1	ø 90 mm	Scarico automatico 1 via	42
PILAV2	ø 90 mm	Scarico automatico 2 vie	70



CODICE	MISURA	DESCRIZIONE	€ iva esclusa
GANCIST06		Kit 6 ganci per il montaggio sotto-top.	28



KITFRESA

FRESA

CODICE	MISURA	DESCRIZIONE	€ iva esclusa
KITFRESA		Kit per foratura del lavello, composto da codolo + fresa diamantata ø 35-37mm	160
FRESA		Fresa diamantata ø 35-37mm	114

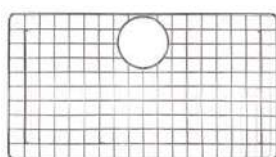

CODICE	MISURA	DESCRIZIONE	€ iva esclusa
GRID76	630X340	Griglia fondo vasca per ON7610.	124
GRID84	680X360	Griglia fondo vasca per ON8410.	142

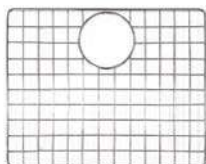

CODICE	MISURA	DESCRIZIONE	€ iva esclusa
GRID60	425X340	Griglia fondo vasca per ON6010, ON5610.	96

CORRETTA PROCEDURA PER LA FORATURA DEI LAVELLI

Tutti i lavelli Plados sono provvisti di prefori per il montaggio della rubinetteria. In alcuni modelli sono presenti più prefori (fig. A) per cui l'installatore può decidere dove posizionare il rubinetto. **ATTENZIONE:** Per evitare rotture del lavello, il completamento del foro va effettuato solo ed esclusivamente con una fresa Ø35-37 mm, seguendo le indicazioni mostrate nelle figure B e C. Plados può fornire sia il **kit completo** per la foratura del lavello composto da **Codolo + Fresa (code KITFRESA)**, sia la **fresa diamantata di ricambio (code FRESA)**, vedi accessori nella pagina.



VIDEO TUTORIAL



A - Prefori presenti nei lavelli Plados



B - Posizionare la fresa in corrispondenza del preforo



C - Procedere con il completamento del foro



MISCELATORI



3 e 4 VIE	186
SISTEMA FILTRANTE	189
POLYTECH	190
PROFESSIONAL	192
ELEGANT	196
DESIGN	202
BASIC	212
SOTTO-FINESTRA	216
ANTICATI	218

I miscelatori Plados hanno un funzionamento ottimale se sono soddisfatte le seguenti condizioni:

- Pressione di esercizio: 1,5-5 bar
- Temperatura max: 80° C

Qualora si riscontrasse una pressione superiore a 5 bar, è consigliabile installare un riduttore di pressione. Granelli di sabbia o altre impurità, sempre presenti nell'acqua, possono danneggiare la cartuccia miscelatrice o le guarnizioni di tenuta, provocando perdite nel miscelatore. L'installazione, a monte dello stesso, di una coppia di rubinetti di arresto con filtro ispezionabile nei due flessibili di adduzione dell'acqua calda e dell'acqua fredda, preserva il miscelatore da detti inconvenienti.



ITALIAN
TECHNOLOGY

ROTAZIONE LEVA A 90°



Il risparmio passa anche dai piccoli dettagli: Le nuove cartucce dei miscelatori Plados hanno una rotazione di 90°. La leva ruota solo in avanti e ciò, oltre a consentire l'installazione del miscelatore in spazi limitati o in prossimità della parete posteriore, permette di evitare inutili accensioni della caldaia contribuendo così ad un notevole risparmio energetico.

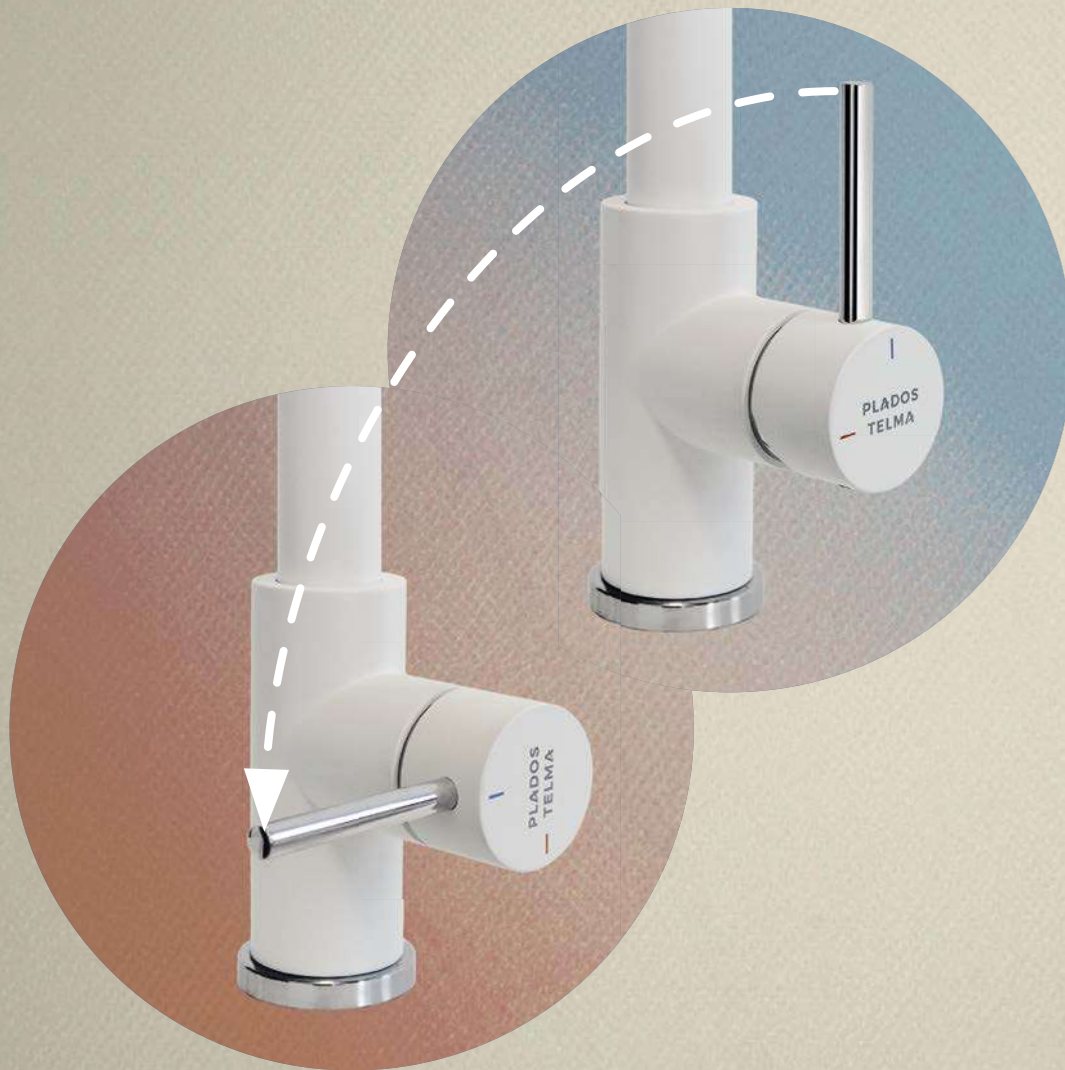

GREENPEACE STIMA CHE, MEDIAMENTE, OGNI ITALIANO CONSUMA
QUATTORDICI BOTTIGLIE DI PLASTICA AL MESE.

MOLTIPLICATE PER IL NUMERO DI ABITANTI E PER DODICI MESI, FANNO

10.000.000.000
DI BOTTIGLIE DI PLASTICA ALL'ANNO.

Fonte: articolo del 1/07/2021,
"L'insostenibile peso delle bottiglie di plastica"
www.greenpeace.org

Scegliere un sistema per l'acqua filtrata significa:

- Salvaguardare l'ambiente riducendo il consumo di plastica;
- Risparmiare fatica, tempo e denaro sull'acquisto e il trasporto di pesanti bottiglie, che andranno poi smaltite;
- Benefici per la salute grazie a una migliore qualità dell'acqua.

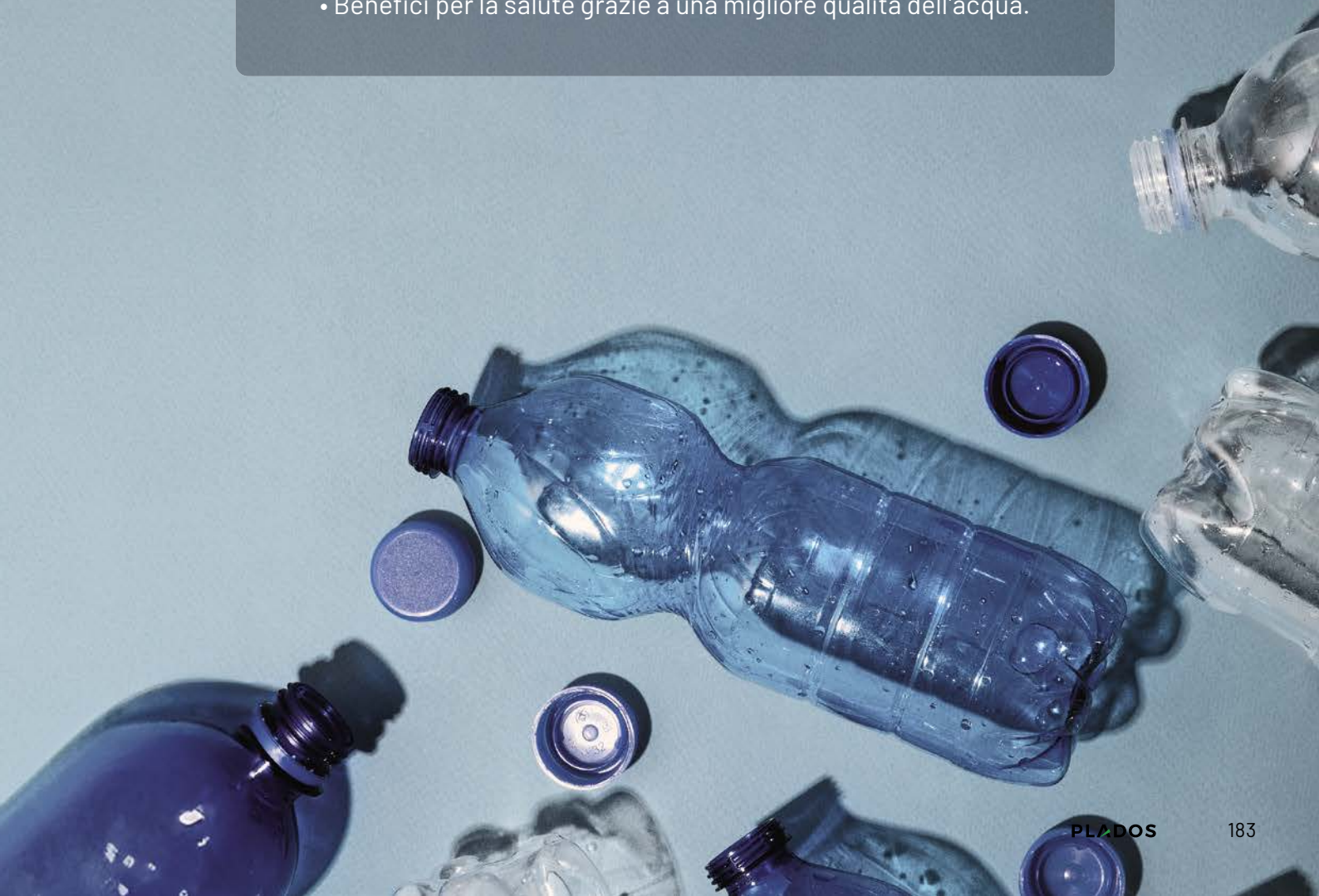

MISCELATORI/TRIFLOW

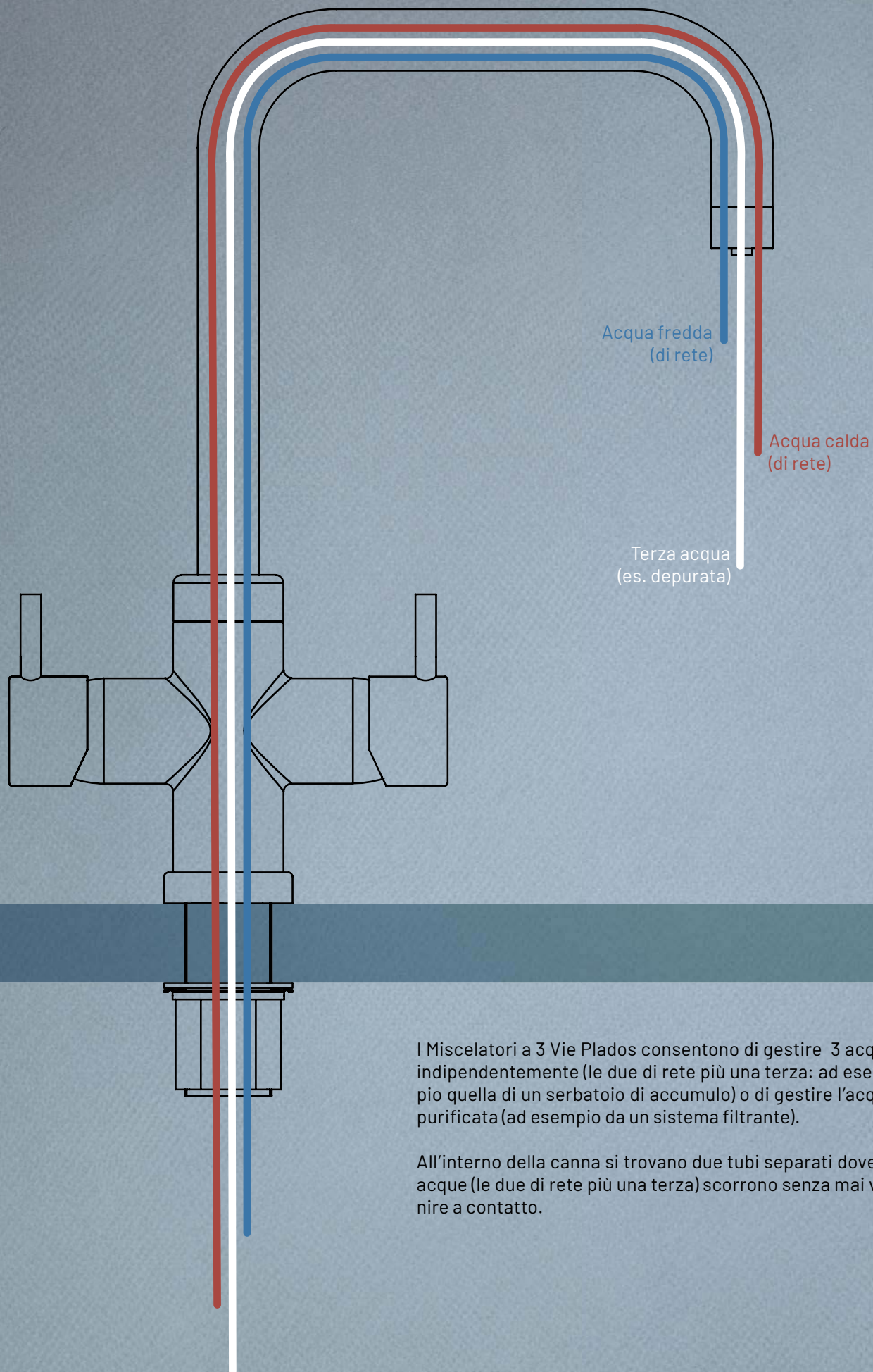

I Miscelatori a 3 Vie Plados consentono di gestire 3 acque indipendentemente (le due di rete più una terza: ad esempio quella di un serbatoio di accumulo) o di gestire l'acqua purificata (ad esempio da un sistema filtrante).

All'interno della canna si trovano due tubi separati dove le acque (le due di rete più una terza) scorrono senza mai venire a contatto.

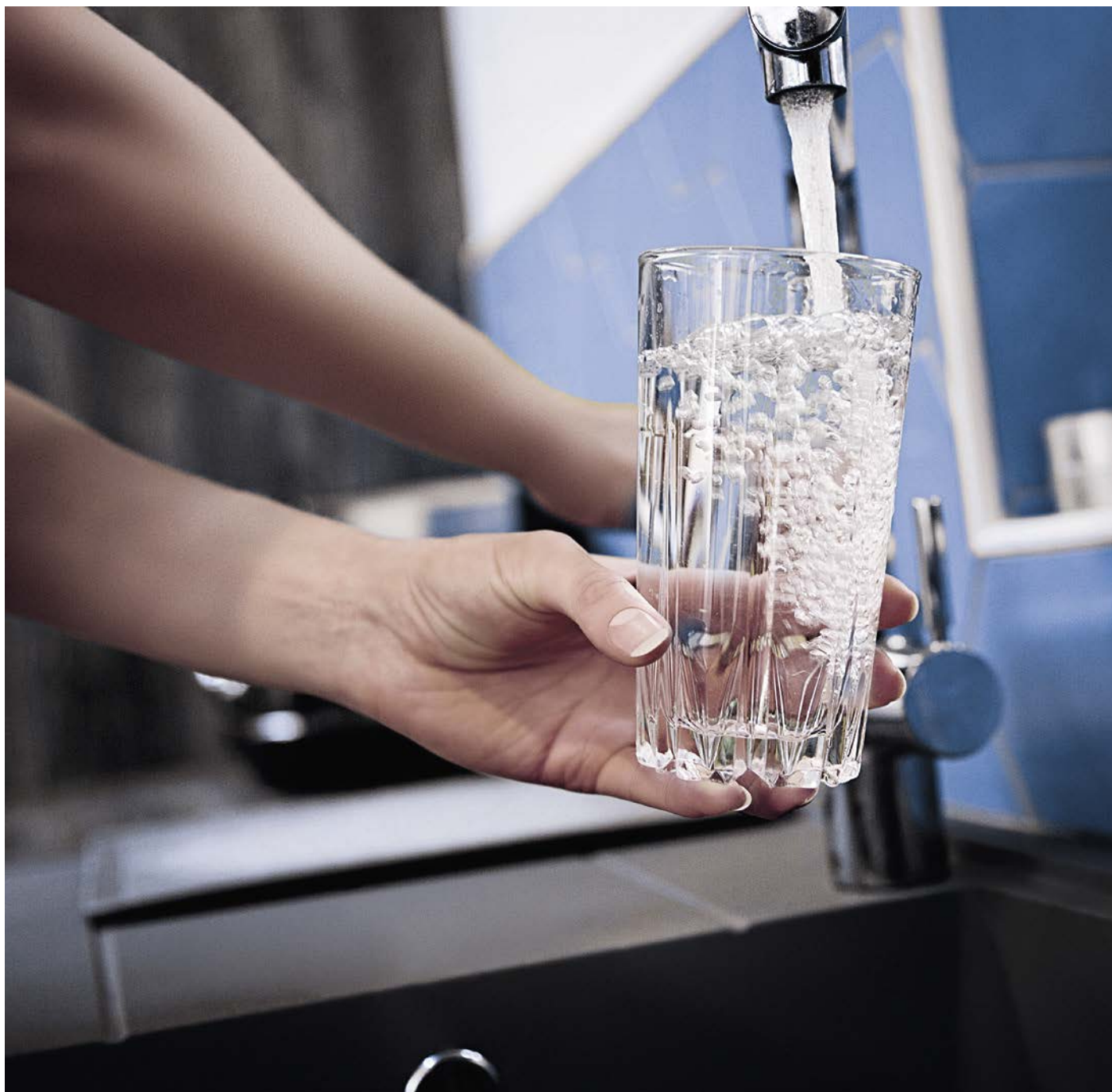

A differenza dei miscelatori di altri fabbricanti, il corpo interno dei miscelatori a tre vie Plados è realizzato in **tecnopolimeri** certificati per il contatto con alimenti, mentre il tubo di erogazione dell'acqua depurata è in **acciaio inox o in polietilene**, anziché in ottone: per la salute dei consumatori ciò rappresenta un enorme salto di qualità perché è noto a tutti che l'ottone al passaggio dell'acqua corrente rilascia metalli pesanti quali piombo, nickel e rame, tutti elementi molto dannosi per la salute. Oltre a ciò, i miscelatori sono dotati di una sofisticata **guarnizione a doppio labbro** che assicura una maggiore tenuta anche in presenza di acque particolarmente calcaree e aggressive.



SORGENTE - 4 in 1

ACQUA PURA, FRIZZANTE O NATURALE, DIRETTAMENTE DAL RUBINETTO.

SORGENTE 4 in 1 è un sistema innovativo che permette di avere acqua fresca, pura, gassata o naturale, direttamente dal rubinetto di casa.

Un'alternativa semplice ed economica all'acquisto di acqua in bottiglia. È composto da un filtro che depuratore, una bomboletta di anidride carbonica per produrre acqua gassata, e un chiller per il raffreddamento dell'acqua, sia naturale che gassata.

L'impianto ha dimensioni ridotte per poter essere installato sotto il lavandino della cucina.

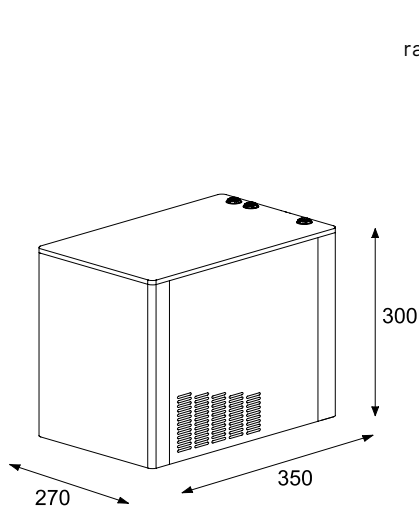
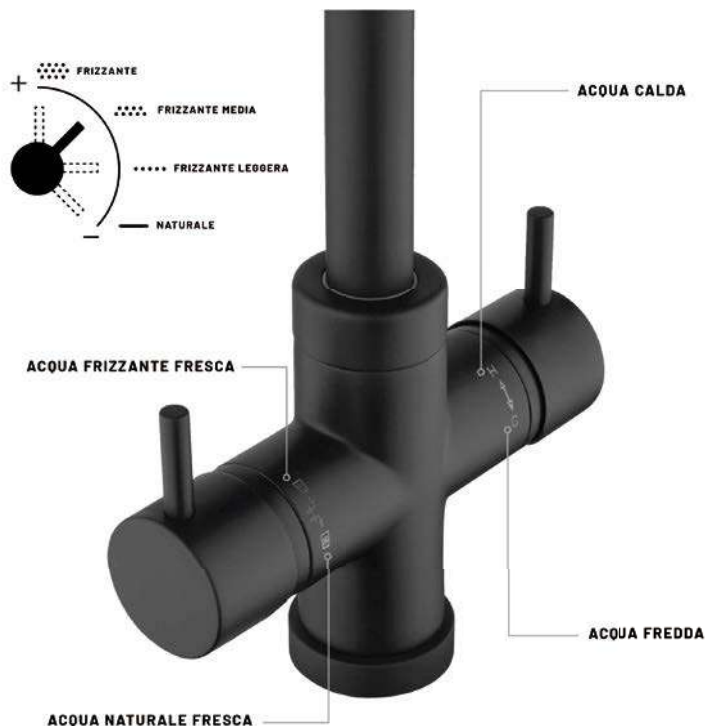

Chiller per il raffreddamento dell'acqua.



Cartuccia CO2 per acqua gassata.

Cartuccia depuratrice

DATI TECNICI

Telaio	Acciaio al carbonio zincato verniciato a polvere
Alimentazione	220-230 Vac 50-60Hz
Compressore	1/8HP con protezione termica e condensatore di spunto
Capacità refrigerante	180W 155Kcal/h
Gas refrigerante	R134a
Condensazione	Acqua
Acqua prodotta	Acqua Naturale, Refrigerata, Gasata Refrigerata
Capacità di erogazione acqua refrigerata	20Lt/h*
Capacità di erogazione acqua gassata	2Lt/m
Saturatore e refrigeratore	3Lt in AISI304
Gruppo di pressurizzazione	5,6 Lt/m PSI

FUNZIONI

- Regolazione temperatura refrigeratore regolabile con sonda di temperatura;
- Regolazione fermata minima sistema di refrigerazione;
- Tempo massimo di funzionamento in continuo;
- Tempo stop forzato;
- Time-Out riempimento tank refrigerato;
- Display;
- Erogazione mediate rubinetto esterno;

SORGENTE1

Miscelatore a 4 vie, con depuratore, refrigeratore e gasatore.



- Cartuccia a dischi ceramici
- Rotazione canna: 180°
- Foro sul lavello: Ø35 mm
- Flessibili di allacciamento in acciaio inox, L=35 cm
- Diametro base: 50 mm

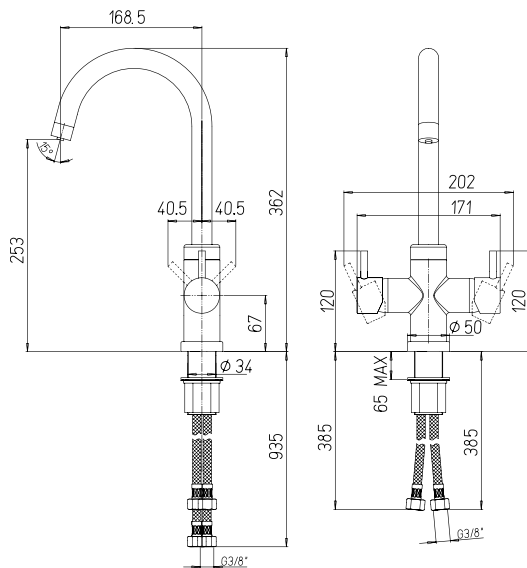

€ IVA esclusa



40 CROMO
SORGENTE1 / 40

4.144

MICROULTRAGRANIT

€ IVA esclusa



UG 70 NERO MATT
SORGENTE1 / 70

4.144

SORGENTE2

Miscelatore a 4 vie, con depuratore, refrigeratore e gasatore.



- Cartuccia a dischi ceramici
- Rotazione canna: 180°
- Foro sul lavello: Ø35 mm
- Flessibili di allacciamento in acciaio inox, L=35 cm
- Diametro base: 50 mm

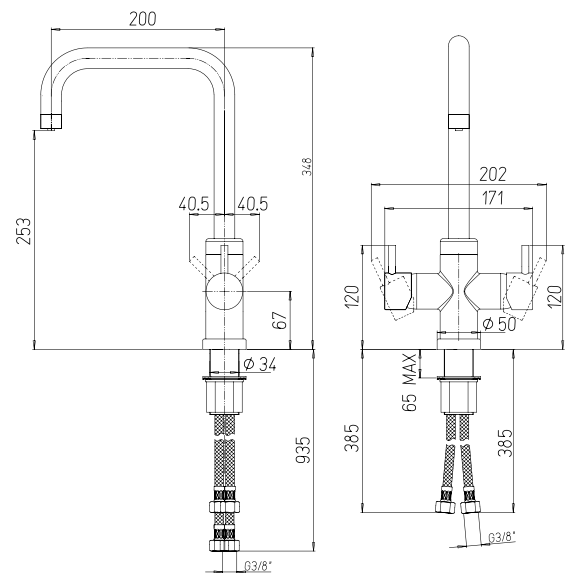

€ IVA esclusa



40 CROMO
SORGENTE2 / 40

4.144

MICROULTRAGRANIT

€ IVA esclusa



UG 70 NERO MATT
SORGENTE2 / 70

4.144

FL055

Miscelatore monocomando a 3 vie,
comando terza acqua indipendente.



NEW

- Cartuccia a dischi ceramici speciale per 3 vie, Ø40 mm (bassa)
- Vitone ceramico 90° sinistro
- Rotazione canna: 180°
- Foro sul lavello: Ø35 mm
- Flessibili di allacciamento in acciaio inox, L=35 cm
- Diametro base: 58 mm

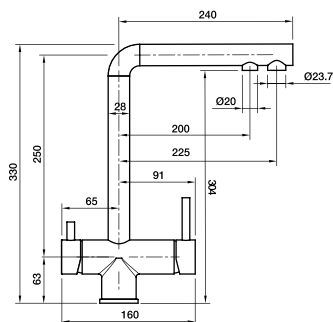

€ IVA esclusa

40 CROMO
FL055 / 40 **374**

MICROULTRAGRANIT

€ IVA esclusa

UG 70 NERO MATT
FL055 / 70

UG 72 TARTUFO
FL055 / 72

UG 94 AVENA
FL055 / 94

UG 98 BIANCO
FL055 / 98

410

ULTRAMETAL

€ IVA esclusa

UM 41 ALLUMINIO
FL055 / 41

UM 42 TITANIO
FL055 / 42

UM 44 NERO
FL055 / 44

428

FL060

Miscelatore monocomando a 3 vie,
comando terza acqua indipendente.



NEW

- Cartuccia a dischi ceramici speciale per 3 vie, Ø35 mm (bassa)
- Vitone ceramico 90° sinistro
- Rotazione canna: 180°
- Foro sul lavello: Ø35 mm
- Flessibili di allacciamento in acciaio inox, L=35 cm
- Diametro base: 50 mm

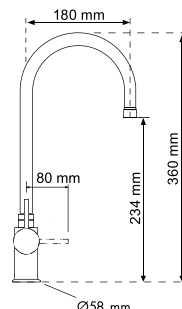

€ IVA esclusa

40 CROMO
FL060 / 40 **374**

MICROULTRAGRANIT

€ IVA esclusa

UG 70 NERO MATT
FL060 / 70

UG 72 TARTUFO
FL060 / 72

UG 94 AVENA
FL060 / 94

UG 98 BIANCO
FL060 / 98

410

ULTRAMETAL

€ IVA esclusa

UM 41 ALLUMINIO
FL060 / 41

UM 42 TITANIO
FL060 / 42

UM 44 NERO
FL060 / 44

428

A differenza dei miscelatori di altri fabbricanti, il corpo interno dei miscelatori a tre vie Plados è realizzato in **tecnopolimeri** certificati per il contatto con alimenti, mentre il tubo di erogazione dell'acqua depurata è in **acciaio inox o in polietilene**, anziché in ottone: per la salute dei consumatori ciò rappresenta un enorme salto di qualità perché è noto a tutti che l'ottone al passaggio dell'acqua corrente rilascia metalli pesanti quali piombo, nickel e rame, tutti elementi molto dannosi per la salute. Oltre a ciò, i miscelatori sono dotati di una sofisticata **guarnizione a doppio labbro** che assicura una maggiore tenuta anche in presenza di acque particolarmente calcaree e aggressive.

SISTEMA FILTRANTE



Il sistema filtrante a carbone attivo vegetale è il complemento ideale per i rubinetti a tre vie in grado di erogare acque separate. Il carbone attivo è in grado di filtrare impurità fino a 5 micron, esercitando anche un'azione batteriostatica. Agenti inquinanti, cloro, odori indesiderati, fibre di amianto, muffe, alghe e cisti protozoarie, vengono trattenuti dal filtro, generando acqua priva di sostanze nocive e pronta da bere.

VANTAGGI DEL SISTEMA FILTRANTE A CARBONE ATTIVO:

- **Salvaguarda l'ambiente** riducendo il consumo di bottiglie di plastica;
- **Risparmia fatica, tempo e denaro**, eliminando acquisto e trasporto di pesanti bottiglie che andranno poi smaltite;
- Installazione o sostituzione del filtro semplici e veloci, **non richiedono intervento tecnico**;
- Il filtro assicura sempre **acqua di qualità**, riducendo automaticamente il flusso d'acqua quando è saturo.
- **Ingresso minimo** in quanto il sistema occupa pochissimo spazio e può essere installato nel sottolavabo.

€ iva esclusa



KITFIL - Kit di installazione

- Testata filtro
- Raccordi
- Tubi di installazione
- Rubinetto di arresto

188

€ iva esclusa



FILCAR - Cartuccia filtrante

- | | |
|-------------------------------------|----------------------------------|
| • Composizione materiale filtrante: | Carbone attivo vegetale di cocco |
| • Composizione materiale filtro: | Alluminio, 100% riciclabile |
| • Composizione materiale testata: | PVC, 100% riciclabile |
| • Pressione di esercizio: | Da 0,7 a 8 bar |
| • Temperatura di esercizio: | Da 4 °C a 38°C |
| • Tipo di manutenzione: | A perdere |
| • Disponibilità: | 10"/20" |
| • Grado di filtrazione: | 5 micron |
| • Portata: | 1,9 L/min |
| • Quantità acqua erogata: | 11.370 L |

164

Dati acqua in ingresso:

- | | |
|---------------|----------|
| • Press. max: | 8 bar |
| • Press. min: | 0,7 bar |
| • Cloro max: | 1,5 mg/L |
| • TDS: | 2000 ppm |
| • Ferro: | Assente |
| • SDI: | 5.0 |



Conforme al D.M. 25/2012 - Tutti i materiali sono atossici. Certificati di atossicità effettuati presso laboratorio specializzato, disponibili su richiesta. Le prestazioni del prodotto possono variare a seconda della portata e della qualità dell'acqua in ingresso. Si raccomanda di sostituire la cartuccia almeno una volta l'anno. L'apparecchio deve funzionare rigorosamente in posizione verticale.

POLYTECH

i rubinetti ecologici

- **Cartuccia + aeratore a risparmio idrico**
- **Installazione rapida SEMPLIFIX**
- **Corpo interno in teflon, senza piombo**
- **Atossici, anallergici, riciclabili**
- **Idonei al contatto con gli alimenti**

Costruiti con materiali ecologici e provvisti di speciali aeratori e cartucce per il risparmio idrico, atossici, riciclabili e idonei per il contatto con gli alimenti. Il corpo interno dei miscelatori POLYTECH è realizzato con innovativi tecnopolimeri che non contengono e non rilasciano nell'acqua metalli pesanti dannosi per la salute, come ad esempio piombo, nichel e rame. Grazie a questi tecnopolimeri, il calcare e le altre impurità presenti nell'acqua scivolano via, evitando progressivi accumuli che potrebbero favorire perdite e creare malfunzionamenti. Sono inoltre provvisti del sistema brevettato SEMPLIFIX® che consente l'installazione rapida dall'alto.



CARTUCCIA SPECIALE A RISPARMIO IDRICO

La cartuccia a risparmio idrico può ridurre gli sprechi fino al 50%. Come? Aprendo la leva si incontra un blocco che limita la portata di acqua a circa 6 litri al minuto. Aprendo ulteriormente la leva si raggiunge l'erogazione standard di circa 12 litri al minuto, con una pressione media di 3 bar.

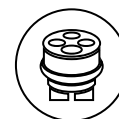
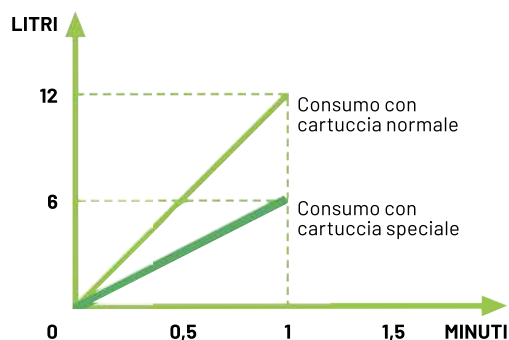
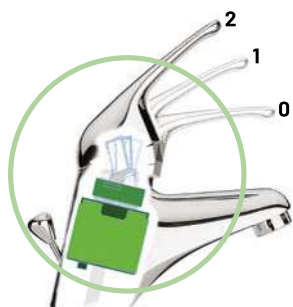

MONTAGGIO RAPIDO DALL'ALTO

Il sistema brevettato SEMPLIFIX® rende facile e veloce sia l'installazione del rubinetto, sia la sostituzione nel tempo. Come mostrano le immagini, le 3 semplici fasi del montaggio avvengono dall'alto ed in pochi minuti, evitando all'installatore di operare in scomode e difficili posizioni.



Inserire dall'alto la base universale Simplifix nel foro del lavello.



Avvitare il blocco con la chiave in dotazione. La base è ora installata.



Fissare il rubinetto alla base con la seconda chiave in dotazione. **FATTO!**

POLITEK10

Miscelatore monocomando con canna tubolare a ponte.



- Cartuccia a dischi ceramici Ø35 mm (bassa)
- Risparmio idrico tramite aeratore: 8,3 L/min
- Rotazione canna: 360°
- Foro sul lavello: Ø35 mm
- Flessibili di allacciamento in acciaio inox, L=35 cm
- Diametro base: 55 mm

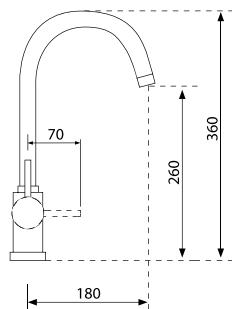

€ IVA esclusa

 40 CROMO
POLITEK10 / 40 **164**

MICROULTRAGRANIT € IVA esclusa

 UG 70 NERO MATT
POLITEK10 / 70 **202**

 UG 94 AVENA
POLITEK10 / 94 **202**

 UG 98 BIANCO
POLITEK10 / 98 **202**

ULTRAMETAL € IVA esclusa

 UM 41 ALLUMINIO
POLITEK10 / 41 **220**

 UM 42 TITANIO
POLITEK10 / 42 **220**

 UM 44 NERO
POLITEK10 / 44 **220**



MONTAGGIO
RAPIDO



CARTUCCIA SPECIALE
RISPARMIO IDRICO

POLITEK20

Miscelatore monocomando con canna a 90°.



- Cartuccia a dischi ceramici Ø35 mm (bassa)
- Risparmio idrico tramite aeratore: 8,3 L/min
- Rotazione canna: 360°
- Foro sul lavello: Ø35 mm
- Flessibili di allacciamento in acciaio inox, L=35 cm
- Diametro base: 55 mm

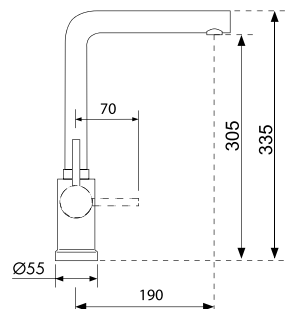

€ IVA esclusa

 40 CROMO
POLITEK20 / 40 **192**

MICROULTRAGRANIT € IVA esclusa

 UG 70 NERO MATT
POLITEK20 / 70 **228**

 UG 98 BIANCO
POLITEK20 / 98 **228**

ULTRAMETAL € IVA esclusa

 UM 41 ALLUMINIO
POLITEK20 / 41 **246**

 UM 42 TITANIO
POLITEK20 / 42 **246**

 UM 44 NERO
POLITEK20 / 44 **246**



MONTAGGIO
RAPIDO



CARTUCCIA SPECIALE
RISPARMIO IDRICO

HEGO

Miscelatore monocomando con doccetta sganciabile a doppio getto, attacco doccia automatico.



- Cartuccia a dischi ceramici Ø25 mm (bassa)
- Rotazione canna: 360°
- Foro sul lavello: Ø35 mm
- Flessibili di allacciamento in acciaio inox, L=35 cm
- Diametro base: 52 mm

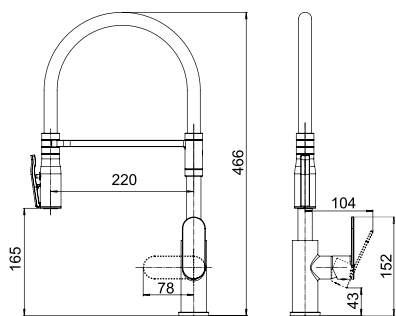

MICROULTRAGRANIT

€ IVA esclusa



UG 70 NERO MATT
HEGO / 70

388



NANOSTONE

€ IVA esclusa



NS N6 DEEP BLACK
HEGO / N6

420



SHOWERMID

Miscelatore monocomando con doccetta sganciabile a doppio getto, attacco doccia automatico.



- Cartuccia a dischi ceramici Ø35 mm (bassa)
- Rotazione canna: 360°
- Foro sul lavello: Ø35 mm
- Flessibili di allacciamento in acciaio inox, L=35 cm
- Diametro base: 50 mm

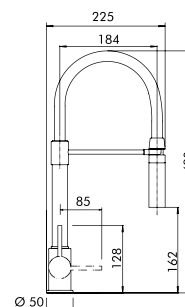

MICROULTRAGRANIT

€ IVA esclusa



40 CROMO
SHOWERMID / 40

310



MICROULTRAGRANIT

€ IVA esclusa



UG 70 NERO MATT
SHOWERMID / 70

342





SPRINGP30

Miscelatore monocomando con doccetta sganciabile a doppio getto, attacco doccia automatico.



- Cartuccia a dischi ceramici Ø35 mm (bassa)
- Rotazione canna: 360°
- Foro sul lavello: Ø35 mm
- Flessibili di allacciamento in acciaio inox, L=35 cm
- Diametro base: 50 mm

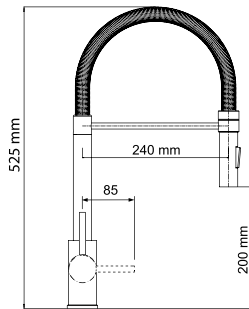

€ IVA esclusa

40 CROMO
SPRINGP30 / 40

334

SPRINGP40

Miscelatore monocomando con doccetta sganciabile a doppio getto, attacco doccia automatico.



- Cartuccia a dischi ceramici Ø35 mm (bassa)
- Rotazione canna: 360°
- Foro sul lavello: Ø35 mm
- Flessibili di allacciamento in acciaio inox, L=35 cm
- Diametro base: 45 mm

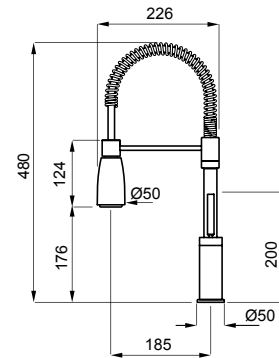

€ IVA esclusa

40 CROMO
SPRINGP40 / 40

374

MICROULTRAGRANIT

€ IVA esclusa

UG 70 NERO MATT
SPRINGP40 / 70

410



NEWMIX80

Miscelatore monocomando
con canna tubolare a ponte.



- Cartuccia a dischi ceramici Ø35 mm (bassa)
- Rotazione canna: 360°
- Foro sul lavello: Ø35 mm
- Flessibili di allacciamento in acciaio inox, L=35 cm
- Diametro base: 48 mm

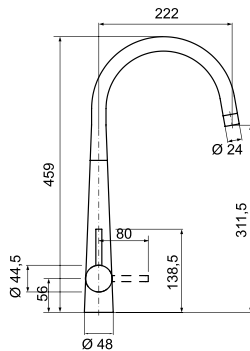

€ IVA esclusa

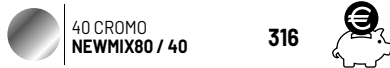

MICROULTRAGRANIT

€ IVA esclusa

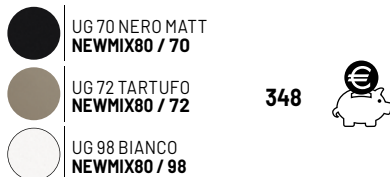

ULTRAMETAL

€ IVA esclusa

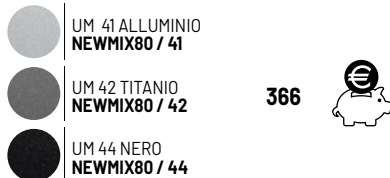

NANOSTONE

€ IVA esclusa

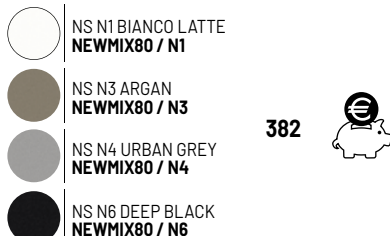

NEWMIX90

Miscelatore monocomando
con bocchetta estraibile a doppio getto.



- Cartuccia a dischi ceramici Ø35 mm (bassa)
- Rotazione canna: 180°
- Foro sul lavello: Ø35 mm
- Flessibili di allacciamento in acciaio inox, L=35 cm
- Flessibile doccetta in nylon, L=150 cm
- Diametro base: 54 mm

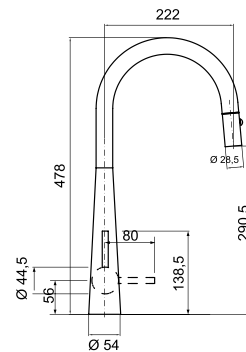

€ IVA esclusa



MICROULTRAGRANIT

€ IVA esclusa

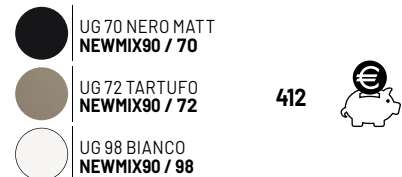

ULTRAMETAL

€ IVA esclusa

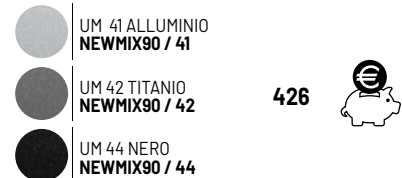

NANOSTONE

€ IVA esclusa





PLADOS
TEMA

PLADOS
TEMA

NEWMIX30

Miscelatore monocomando con canna tubolare a due pieghe.



- Cartuccia a dischi ceramici Ø35 mm (alta)
- Rotazione canna: 360°
- Foro sul lavello: Ø35 mm
- Flessibili di allacciamento in acciaio inox, L=35 cm
- Diametro base: 48 mm

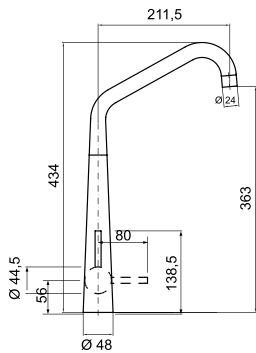

€ IVA esclusa

40 CROMO
NEWMIX30 / 40 **316**



MICROULTRAGRANIT € IVA esclusa

UG 70 NERO MATT
NEWMIX30 / 70

UG 72 TARTUFO
NEWMIX30 / 72 **348**



UG 98 BIANCO
NEWMIX30 / 98

ULTRAMETAL € IVA esclusa

UM 41 ALLUMINIO
NEWMIX30 / 41

UM 42 TITANIO
NEWMIX30 / 42 **366**



UM 44 NERO
NEWMIX30 / 44

NANOSTONE € IVA esclusa

NS N1 BIANCO LATTE
NEWMIX30 / N1

NS N3 ARGAN
NEWMIX30 / N3 **382**



NS N4 URBAN GREY
NEWMIX30 / N4

NS N6 DEEP BLACK
NEWMIX30 / N6

MIG10

Miscelatore monocomando con canna piatta.



- Cartuccia a dischi ceramici Ø28 mm
- Rotazione canna: 130°
- Foro sul lavello: Ø35 mm
- Flessibili di allacciamento in acciaio inox, L=35 cm
- Diametro base: 48 mm

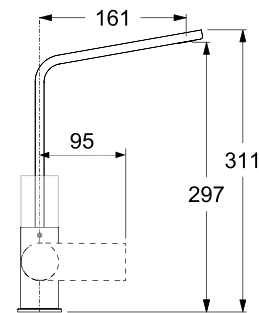

€ IVA esclusa

40 CROMO
MIG10 / 40 **392**

MICROULTRAGRANIT € IVA esclusa

UG 70 NERO MATT
MIG10 / 70 **428**

NANOSTONE € IVA esclusa

NS N6 DEEP BLACK
MIG10 / N6 **466**



SPIRIT

Miscelatore monocomando con canna piatta.



- Cartuccia a dischi ceramici Ø25 mm
- Rotazione canna: 180°
- Foro sul lavello: Ø35 mm
- Flessibili di allacciamento in acciaio inox, L=35 cm
- Diametro base: 48 mm

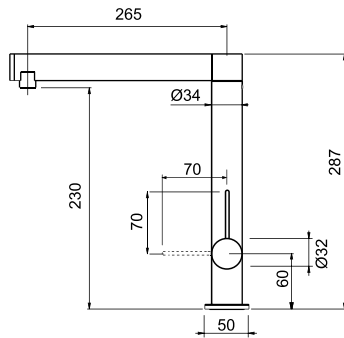

€ IVA esclusa

40 CROMO
SPIRIT / 40 **448**

MICROULTRAGRANIT € IVA esclusa

UG 70 NERO MATT
SPIRIT / 70 **484**

NANOSTONE € IVA esclusa

NS N6 DEEP BLACK
SPIRIT / N6 **520**

NILO

Miscelatore monocomando con leva frontale.



- Cartuccia a dischi ceramici Ø25 mm (bassa)
- Rotazione canna: 180°
- Foro sul lavello: Ø35 mm
- Flessibili di allacciamento in acciaio inox, L=35 cm
- Diametro base: 50 mm

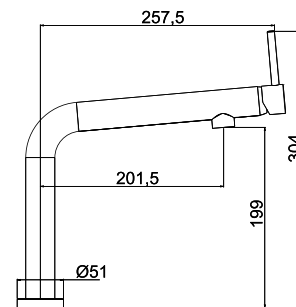

€ IVA esclusa

40 CROMO
NILO / 40 **328**

MICROULTRAGRANIT € IVA esclusa

UG 70 NERO MATT
NILO / 70 **366**

NANOSTONE € IVA esclusa

NS N6 DEEP BLACK
NILO / N6 **384**



PLADOS
TELMA

NEMO

Miscelatore monocomando con canna a L e doccetta estraibile.



NEW



PVD ORO



PVD RAME



PVD BLACK



39 ACCIAIO SATINATO

- Cartuccia a dischi ceramici Ø35 mm (bassa)
- Rotazione canna: 180°
- Foro sul lavello: Ø35 mm
- Flessibili di allacciamento in acciaio inox, L=35 cm
- Diametro base: 50 mm

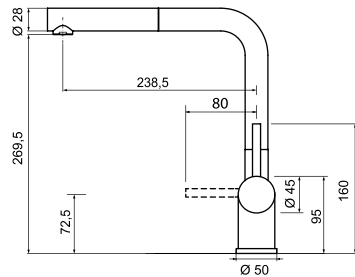

		€ IVA esclusa	
	40 CROMO NEMO / 40	290	
	39 ACCIAIO SATINATO NEMO / 39	376	
	PVD ORO NEMO / OR	376	
	PVD RAME NEMO / RA	376	
	PVD BLACK NEMO / BL	376	
MICROULTRAGRANIT			
		€ IVA esclusa	
	UG 70 NERO MATT NEMO / 70	324	
NANOSTONE			
		€ IVA esclusa	
	NS N6 DEEP BLACK NEMO / N6	358	



PLADOS

PLADOS
TELMA

COLONNA

Miscelatore monocomando con canna a L.



- Cartuccia a dischi ceramici Ø35 mm (bassa)
- Rotazione canna: 360°
- Foro sul lavello: Ø35 mm
- Flessibili di allacciamento in acciaio inox, L=35 cm
- Diametro base: 50 mm

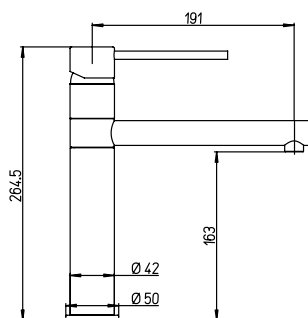

€ IVA esclusa

40 CROMO
COLONNA / 40 **242**

MICROULTRAGRANIT € IVA esclusa

UG 70 NERO MATT
COLONNA / 70

UG 72 TARTUFO
COLONNA / 72 **278**

UG 98 BIANCO
COLONNA / 98

ULTRAMETAL € IVA esclusa

UM 41 ALLUMINIO
COLONNA / 41

UM 42 TITANIO
COLONNA / 42 **296**

UM 44 NERO
COLONNA / 44



HYDRA

Miscelatore monocomando con doccia estraibile a doppio getto.



- Cartuccia a dischi ceramici Ø35 mm (alta)
- Rotazione canna: 180°
- Foro sul lavello: Ø35 mm
- Flessibili di allacciamento in acciaio inox, L=35 cm
- Flessibile doccia in nylon, L=150 cm
- Diametro base: 50 mm

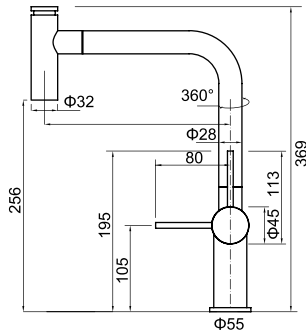

€ IVA esclusa

	40 CROMO HYDRA / 40	288
MICROULTRAGRANIT		
€ IVA esclusa		
	UG 70 NERO MATT HYDRA / 70	324
NANOSTONE		
€ IVA esclusa		
	NS N6 DEEP BLACK HYDRA / N6	360

DEMIXEXTL

Miscelatore monocomando con canna a 90° e doccia estraibile.



- Cartuccia a dischi ceramici Ø35 mm (alta)
- Rotazione canna: 180°
- Foro sul lavello: Ø35 mm
- Flessibili di allacciamento in acciaio inox, L=35 cm
- Flessibile doccia in nylon, L=150 cm
- Diametro base: 50 mm

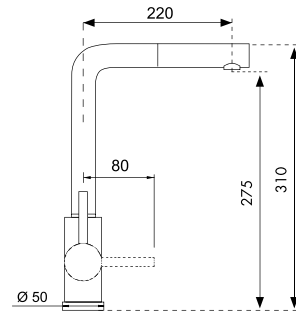

€ IVA esclusa

	40 CROMO DEMIXEXTL / 40	230
MICROULTRAGRANIT		
€ IVA esclusa		
	UG 56 JASMINE DEMIXEXTL / 56	
	UG 70 NERO MATT DEMIXEXTL / 70	
	UG 72 TARTUFO DEMIXEXTL / 72	
	UG 90 BIANCO OPALE DEMIXEXTL / 90	264
	UG 94 AVENA DEMIXEXTL / 94	
	UG 95 NERO EBONY DEMIXEXTL / 95	
	UG 98 BIANCO DEMIXEXTL / 98	

ULTRAMETAL

	UM 41 ALLUMINIO DEMIXEXTL / 41	
	UM 42 TITANIO DEMIXEXTL / 42	278
	UM 14 CONCRETE DEMIXEXTL / 14	
	UM 44 NERO DEMIXEXTL / 44	

NANOSTONE

	NS N1 BIANCO LATTE DEMIXEXTL / N1	
	NS N3 ARGAN DEMIXEXTL / N3	296
	NS N4 URBAN GREY DEMIXEXTL / N4	
	NS N6 DEEP BLACK DEMIXEXTL / N6	



PARMIXEXT

Miscelatore monocomando con bocchetta estraibile e leva joystick.



- Cartuccia a dischi ceramici Ø25 mm
- Rotazione canna: 170°
- Foro sul lavello: Ø35 mm
- Flessibili di allacciamento in acciaio inox, L=35 cm
- Flessibile doccetta in nylon, L=150 cm
- Diametro base: 55 mm

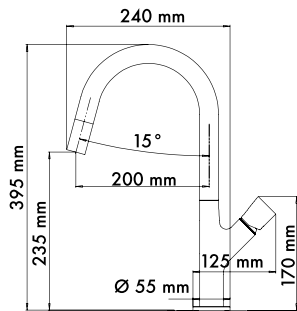

€ IVA esclusa

40 CROMO
PARMIXEXT / 40 **356**

MICROULTRAGRANIT € IVA esclusa

UG 70 NERO MATT
PARMIXEXT / 70

UG 72 TARTUFO
PARMIXEXT / 72 **392**

UG 98 BIANCO
PARMIXEXT / 98

ULTRAMETAL € IVA esclusa

UM 41 ALLUMINIO
PARMIXEXT / 41

UM 42 TITANIO
PARMIXEXT / 42 **410**

UM 44 NERO
PARMIXEXT / 44

NANOSTONE € IVA esclusa

NS N6 DEEP BLACK
PARMIXEXT / N6 **428**

PUNTOBPEX

Miscelatore monocomando con canna tubolare e bocchetta estraibile.



- Cartuccia a dischi ceramici Ø35 mm (alta)
- Rotazione canna: 180°
- Foro sul lavello: Ø35 mm
- Flessibili di allacciamento in acciaio inox, L=35 cm
- Flessibile doccetta in nylon, L=150 cm
- Diametro base: 50 mm

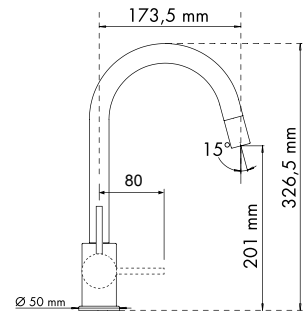

€ IVA esclusa

40 CROMO
PUNTOBPEX / 40 **212**

MICROULTRAGRANIT € IVA esclusa

UG 56 JASMINE
PUNTOBPEX / 56

UG 70 NERO MATT
PUNTOBPEX / 70

UG 72 TARTUFO
PUNTOBPEX / 72 **246**

UG 90 BIANCO OPALE
PUNTOBPEX / 90

UG 94 AVENA
PUNTOBPEX / 94

UG 95 NERO EBONY
PUNTOBPEX / 95

UG 98 BIANCO
PUNTOBPEX / 98

ULTRAMETAL € IVA esclusa

UM 41 ALLUMINIO
PUNTOBPEX / 41

UM 42 TITANIO
PUNTOBPEX / 42 **264**

UM 44 NERO
PUNTOBPEX / 44



PLADOS
TELMA

VENMIXEXT

Miscelatore monocomando con doccetta estraibile.



- Cartuccia a dischi ceramici Ø35 mm (bassa)
- Rotazione canna: 180°
- Foro sul lavello: Ø35 mm
- Flessibili di allacciamento in acciaio inox, L=35 cm
- Flessibile doccetta in nylon, L=150 cm
- Diametro base: 50 mm

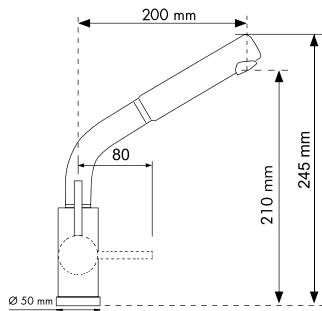

€ IVA esclusa

40 CROMO
VENMIXEXT / 40 **252**

MICROULTRAGRANIT € IVA esclusa

UG 70 NERO MATT
VENMIXEXT / 70

UG 72 TARTUFO
VENMIXEXT / 72 **288**

UG 98 BIANCO
VENMIXEXT / 98

ULTRAMETAL € IVA esclusa

UM 41 ALLUMINIO
VENMIXEXT / 41

UM 42 TITANIO
VENMIXEXT / 42 **306**

UM 44 NERO
VENMIXEXT / 44

TIZMIXEXT

Miscelatore monocomando con doccetta estraibile a doppio getto.



- Cartuccia a dischi ceramici Ø35 mm (alta)
- Rotazione canna: 120°
- Foro sul lavello: Ø35 mm
- Flessibili di allacciamento in acciaio inox, L=50 cm
- Flessibile doccetta in nylon, L=150 cm
- Diametro base: 50 mm

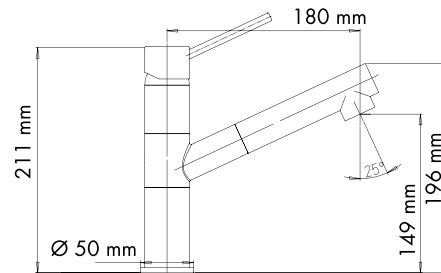

€ IVA esclusa

40 CROMO
TIZMIXEXT / 40 **274**

MICROULTRAGRANIT € IVA esclusa

UG 70 NERO MATT
TIZMIXEXT / 70

UG 94 AVENA
TIZMIXEXT / 94 **310**

UG 98 BIANCO
TIZMIXEXT / 98

ULTRAMETAL € IVA esclusa

UM 41 ALLUMINIO
TIZMIXEXT / 41

UM 42 TITANIO
TIZMIXEXT / 42 **328**

UM 44 NERO
TIZMIXEXT / 44

SLIMFIX

Miscelatore monocomando con corpo "slim" e canna a ponte.



- Cartuccia a dischi ceramici Ø25 mm
- Rotazione canna: 360°
- Foro sul lavello: Ø35 mm
- Flessibili di allacciamento in acciaio inox, L=35 cm
- Diametro base: 45 mm

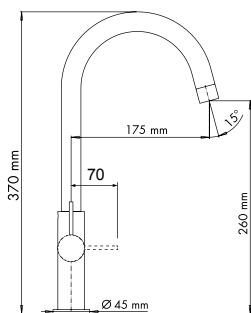

€ IVA esclusa

40 CROMO
SLIMFIX / 40 **210**

MICROULTRAGRANIT

€ IVA esclusa

UG 70 NERO MATT
SLIMFIX / 70

UG 72 TARTUFO
SLIMFIX / 72 **246**

UG 98 BIANCO
SLIMFIX / 98

ULTRAMETAL

€ IVA esclusa

UM 41 ALLUMINIO
SLIMFIX / 41

UM 42 TITANIO
SLIMFIX / 42 **266**

UM 44 NERO
SLIMFIX / 44

VENMIXL

Miscelatore monocomando canna a 90°.



- Cartuccia a dischi ceramici Ø25 mm (bassa)
- Rotazione canna: 360°
- Foro sul lavello: Ø35 mm
- Flessibili di allacciamento in acciaio inox, L=35 cm
- Diametro base: 45 mm

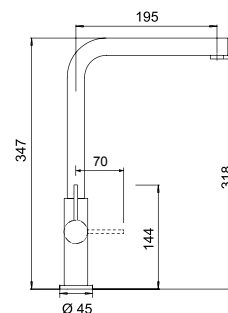

€ IVA esclusa

40 CROMO
VENMIXL / 40 **214**

MICROULTRAGRANIT

€ IVA esclusa

UG 56 JASMINE
VENMIXL / 56

UG 70 NERO MATT
VENMIXL / 70

UG 72 TARTUFO
VENMIXL / 72

UG 90 BIANCO OPALE
VENMIXL / 90 **252**

UG 94 AVENA
VENMIXL / 94

UG 95 NERO EBONY
VENMIXL / 95

UG 98 BIANCO
VENMIXL / 98

ULTRAMETAL

€ IVA esclusa

UM 41 ALLUMINIO
VENMIXL / 41

UM 42 TITANIO
VENMIXL / 42 **270**

UM 14 CONCRETE
VENMIXL / 14

UM 44 NERO
VENMIXL / 44

NANOSTONE

€ IVA esclusa

NS N1 BIANCO LATTE
VENMIXL / N1

NS N3 ARGAN
VENMIXL / N3 **288**

NS N4 URBAN GREY
VENMIXL / N4

NS N6 DEEP BLACK
VENMIXL / N6

TIZEK

Miscelatore monocomando con canna girevole.



- Cartuccia a dischi ceramici Ø35 mm (bassa)
- Rotazione canna: 360°
- Foro sul lavello: Ø35 mm
- Flessibili di allacciamento in acciaio inox, L=35 cm
- Diametro base: 50 mm

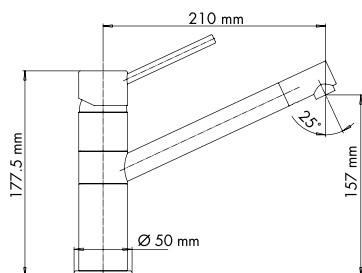

€ IVA esclusa

40 CROMO
TIZEK / 40 **220**

MICROULTRAGRANIT

€ IVA esclusa

UG 70 NERO MATT
TIZEK / 70

UG 94 AVENA
TIZEK / 94 **256**

UG 98 BIANCO
TIZEK / 98

ULTRAMETAL

€ IVA esclusa

UM 41 ALLUMINIO
TIZEK / 41

UM 42 TITANIO
TIZEK / 42 **274**

UM 44 NERO
TIZEK / 44

EASY

Miscelatore monocomando con canna girevole a L.



- Cartuccia a dischi ceramici Ø35 mm (bassa)
- Rotazione canna: 360°
- Foro sul lavello: Ø35 mm
- Flessibili di allacciamento in acciaio inox, L=35 cm
- Diametro base: 50 mm

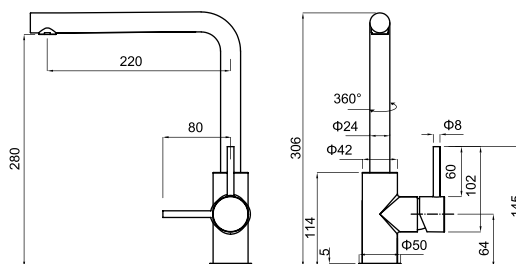

€ IVA esclusa

40 CROMO
EASY / 40 **176**

MICROULTRAGRANIT

€ IVA esclusa

UG 70 NERO MATT
EASY / 70

UG 72 TARTUFO
EASY / 72

UG 94 AVENA
EASY / 94 **210**

UG 98 BIANCO
EASY / 98

ULTRAMETAL

€ IVA esclusa

UM 41 ALLUMINIO
EASY / 41

UM 42 TITANIO
EASY / 42 **224**

UM 44 NERO
EASY / 44

PETRAMIX

Miscelatore monocomando con canna tubolare.



- Cartuccia a dischi ceramici Ø35 mm (alta)
- Rotazione canna: 360°
- Foro sul lavello: Ø35 mm
- Flessibili di allacciamento in acciaio inox, L=35 cm
- Diametro base: 50 mm

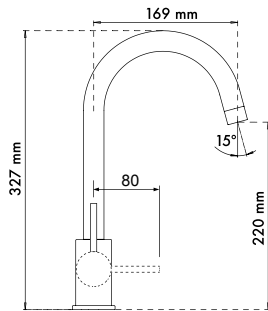

€ IVA esclusa

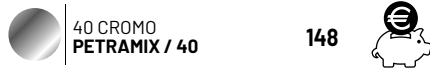

ULTRAQUARTZ € IVA esclusa



MICROULTRAGRANIT € IVA esclusa

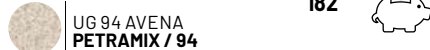

ULTRAMETAL € IVA esclusa

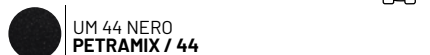

VENMIX20

Miscelatore monocomando con canna tubolare.



- Cartuccia a dischi ceramici Ø35 mm (bassa)
- Rotazione canna: 360°
- Foro sul lavello: Ø35 mm
- Flessibili di allacciamento in acciaio inox, L=35 cm
- Diametro base: 50 mm

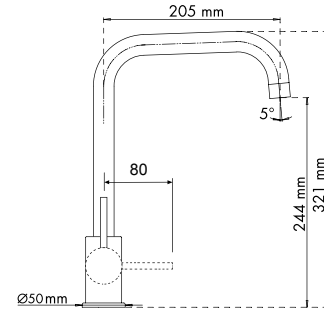

€ IVA esclusa



MICROULTRAGRANIT € IVA esclusa

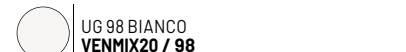
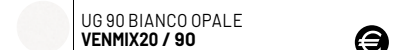

ULTRAMETAL € IVA esclusa

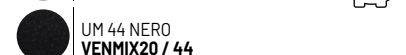
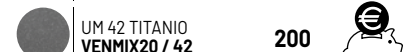

EUROMIX

Miscelatore monocomando con canna fusa.



- Cartuccia a dischi ceramici Ø35 mm (alta)
- Rotazione canna: 360°
- Foro sul lavello: Ø35 mm
- Flessibili di allacciamento in acciaio inox, L=35 cm
- Diametro base: 50 mm

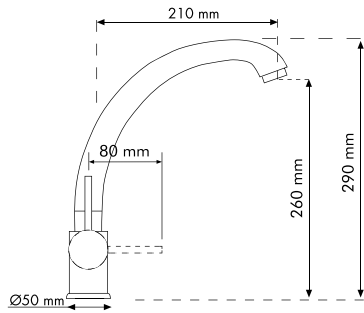

€ IVA esclusa

	40 CROMO EUROMIX / 40	156
-------------------------------------------------------------------------------------	--------------------------	-----

MICROULTRAGRANIT

€ IVA esclusa

	UG 70 NERO MATT EUROMIX / 70	
	UG 94 AVENA EUROMIX / 94	192
	UG 98 BIANCO EUROMIX / 98	

NEOMIX

Miscelatore monocomando con bocca orientabile e leva laterale.



- Cartuccia a dischi ceramici Ø40 mm (alta)
- Rotazione canna: 360°
- Foro sul lavello: Ø35 mm
- Flessibili di allacciamento in acciaio inox, L=35 cm
- Diametro base: 50 mm

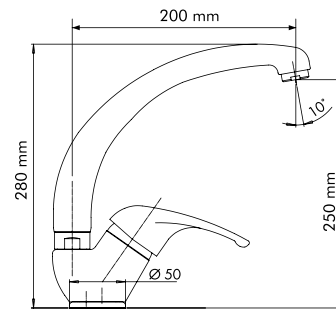



€ IVA esclusa

	40 CROMO NEOMIX / 40	138
--------------------------------------------------------------------------------------	-------------------------	-----

MICROULTRAGRANIT

€ IVA esclusa

	UG 70 NERO MATT NEOMIX / 70	
	UG 94 AVENA NEOMIX / 94	174
	UG 98 BIANCO NEOMIX / 98	

PLUSMIX

Miscelatore monocomando con canna a tubo.



- Cartuccia a dischi ceramici Ø40 mm (alta)
- Rotazione canna: 360°
- Foro sul lavello: Ø35 mm
- Flessibili di allacciamento in acciaio inox, L=35 cm
- Diametro base: 53 mm

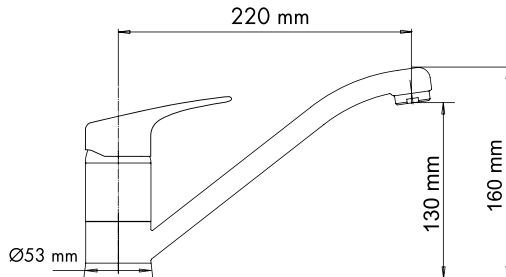

€ IVA esclusa

	40 CROMO PLUSMIX / 40	120
-------------------------------------------------------------------------------------	--------------------------	-----



MICROULTRAGRANIT

€ IVA esclusa

	UG 56 JASMINE PLUSMIX / 56	
	UG 70 NERO MATT PLUSMIX / 70	
	UG 90 BIANCO OPALE PLUSMIX / 90	156
	UG 94 AVENA PLUSMIX / 94	
	UG 95 NERO EBONY PLUSMIX / 95	
	UG 98 BIANCO PLUSMIX / 98	

ULTRAMETAL

€ IVA esclusa

	UM 41 ALLUMINIO PLUSMIX / 41	
	UM 42 TITANIO PLUSMIX / 42	174
	UM 44 NERO PLUSMIX / 44	

PLUSMIXEXT

Miscelatore monocomando con doccetta estraibile a doppio getto.



- Cartuccia a dischi ceramici Ø40 mm (alta)
- Rotazione canna: 120°
- Foro sul lavello: Ø35 mm
- Flessibili di allacciamento in acciaio inox, L=35 cm
- Flessibile doccetta in nylon, L=150 cm
- Diametro base: 53 mm

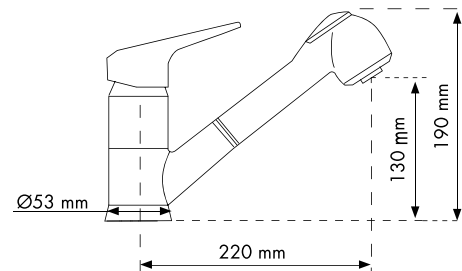

€ IVA esclusa

	40 CROMO PLUSMIXEXT / 40	192
---------------------------------------------------------------------------------------	-----------------------------	-----



MICROULTRAGRANIT

€ IVA esclusa

	UG 56 JASMINE PLUSMIXEXT / 56	
	UG 70 NERO MATT PLUSMIXEXT / 70	
	UG 90 BIANCO OPALE PLUSMIXEXT / 90	228
	UG 94 AVENA PLUSMIXEXT / 94	
	UG 95 NERO EBONY PLUSMIXEXT / 95	
	UG 98 BIANCO PLUSMIXEXT / 98	

ULTRAMETAL

€ IVA esclusa

	UM 41 ALLUMINIO PLUSMIXEXT / 41	
	UM 42 TITANIO PLUSMIXEXT / 42	246
	UM 44 NERO PLUSMIXEXT / 44	

WINMIX

Miscelatore monocomando con canna abbattibile per sottofinestra.



- Cartuccia a dischi ceramici Ø25 mm
- Rotazione canna: 360°
- Foro sul lavello: Ø35 mm
- Flessibili di allacciamento in acciaio inox, L=35 cm
- Diametro base: 55 mm

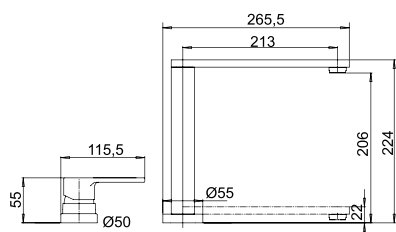

SOTTOFINESTRA
altezza minima 55 mm

	€ IVA esclusa
 40 CROMO WINMIX / 40	538

NOVOMIX

Miscelatore monocomando con canna pieghevole per sottofinestra.





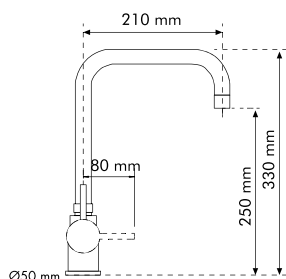



- Cartuccia a dischi ceramici Ø40 mm (alta)
- Rotazione canna: 180°
- Foro sul lavello: Ø35 mm
- Flessibili di allacciamento in acciaio inox, L=35 cm
- Diametro base: 50 mm





SOTTOFINESTRA
altezza minima 80 mm

	€ IVA esclusa
 40 CROMO NOVOMIX / 40	310

MICROULTRAGRANIT

	€ IVA esclusa
 UG 56 JASMINE NOVOMIX / 56	
 UG 70 NERO MATT NOVOMIX / 70	
 UG 72 TARTUFO NOVOMIX / 72	
 UG 90 BIANCO OPALE NOVOMIX / 90	348
 UG 94 AVENA NOVOMIX / 94	
 UG 95 NERO EBONY NOVOMIX / 95	
 UG 98 BIANCO NOVOMIX / 98	

ULTRAMETAL

	€ IVA esclusa
 UM 41 ALLUMINIO NOVOMIX / 41	
 UM 42 TITANIO NOVOMIX / 42	366
 UM 44 NERO NOVOMIX / 44	

MIXOLDST



Miscelatore monocomando "Old Fashion" con canna pieghevole per sottofinestra.

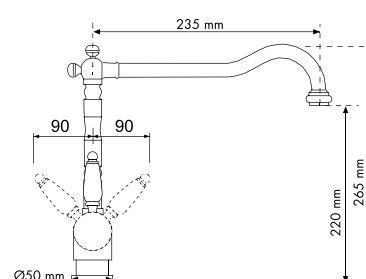

- Cartuccia a dischi ceramici Ø40 mm (alta)
- Rotazione canna: 180°
- Foro sul lavello: Ø35 mm
- Flessibili di allacciamento in acciaio inox, L=35 cm
- Diametro base: 50 mm



SOTTOFINESTRA
altezza minima 80 mm

	€ IVA esclusa
 40 CROMO MIXOLDST / 40	384
 17 RAME ANTICATO MIXOLDST / 17	420
 18 BRONZO ANTICATO MIXOLDST / 18	420



PLADOS
TELMA

MIXOLD

Miscelatore monocomando "Old Fashion" con canna girevole e leva laterale.



- Cartuccia a dischi ceramici Ø40 mm (alta)
- Rotazione canna: 360°
- Foro sul lavello: Ø35 mm
- Flessibili di allacciamento in acciaio inox, L=35 cm
- Diametro base: 50 mm

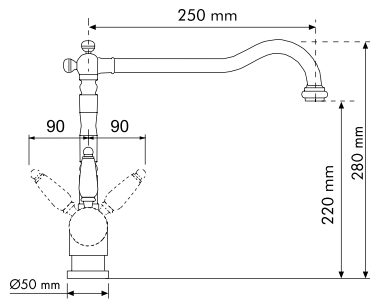





€ IVA esclusa

	40 CROMO MIXOLD / 40	274
	17 RAME ANTICATO MIXOLD / 17	310
	18 BRONZO ANTICATO MIXOLD / 18	310

MICROULTRAGRANIT

€ IVA esclusa

	UG 56 JASMINE MIXOLD / 56	292
	UG 70 NERO MATT MIXOLD / 70	
	UG 94 AVENA MIXOLD / 94	
	UG 98 BIANCO MIXOLD / 98	

IDEAOLD

Gruppo monoforo con canna "Old Fashion" e maniglie a croce.



- Vitoni a bagno olio
- Rotazione canna: 360°
- Foro sul lavello: Ø35 mm
- Flessibili di allacciamento in acciaio inox, L=35 cm
- Diametro base: 45 mm

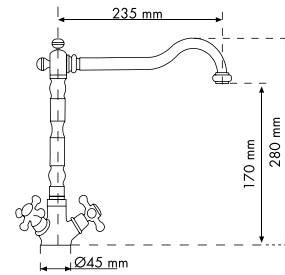

€ IVA esclusa

	40 CROMO IDEAOLD / 40	228
	17 RAME ANTICATO IDEAOLD / 17	266
	18 BRONZO ANTICATO IDEAOLD / 18	266



FORNI





Dal design moderno a quello classico,
i forni multifunzione Plados sono elettrodomestici
di **CLASSE A** rigorosamente **Made in Italy** e garantiscono
la massima qualità e attenzione ai dettagli.



FORNI

CARATTERISTICHE DI PRODOTTO



COLORI TRENDY

I forni Plados sono disponibili nelle finiture più in voga nelle cucine contemporanee.

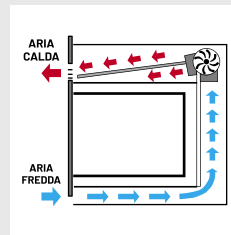

RAFFREDDAMENTO TANGENZIALE

Una ventola esterna al forno evita il surriscaldamento dei mobili adiacenti, la formazione di condensa e di umidità.

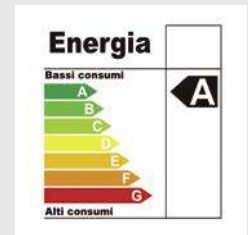

CLASSE A

Scegliere un elettrodomestico ad elevata efficienza energetica **ripaga in termini di costi energetici**.

FINITURE



PLUS



ITALIAN
TECHNOLOGY

CORREDO

- Griglia
- Leccarda

INSTALLAZIONE

- Incasso

FIDIG / FORNO



UG Nero Matt 70



UG Bianco 98



UG Nero Matt 70



UG Tartufo 72



UM Alluminio 41



UM Titanio 42

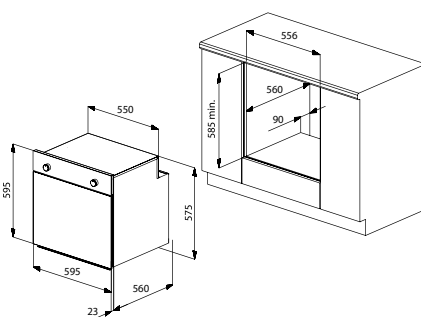

COLORI DISPONIBILI

€ IVA esclusa



UG 98
BIANCO
FIDIG / 98



UG 70
NERO MATT
FIDIG / 70



UG 72
TARTUFO
FIDIG / 72

864



COLORI DISPONIBILI

€ IVA esclusa



UM 41
ALLUMINIO
FIDIG / 41



UM 42
TITANIO
FIDIG / 42

864



DOTAZIONE

- 1 griglia
- 1 vassoio standard

CARATTERISTICHE

- Forno termo ventilato
- Classe di efficienza energetica A
- 9 funzioni
- Cavità extralarge 64 lt netti
- Ventilazione tangenziale di raffreddamento
- 5 livelli di cottura
- Porta fredda in triplo vetro temperato
- Vetro interno removibile
- Programmatore elettronico touch nuova generazione
- Interno con smalto titanium easy-to-clean, più facile da pulire
- Luce interna
- Maniglia nera e manopole milleluci nere



grill



grill ventilato



cottura ventilata



cottura tradizionale ventilata



cottura inferiore ventilata



resistenza superiore + inferiore



resistenza superiore



resistenza inferiore



scongelamento



luce interna



64 L capacità



raffreddamento tangenziale

FIMOD / FORNO



UG Tartufo 72



UG Bianco 98



UG Nero Matt 70



UG Tartufo 72



UM Alluminio 41



UM Titanio 42

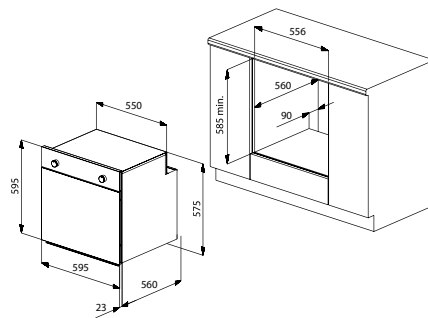

COLORI DISPONIBILI

€ IVA esclusa



UG 98
BIANCO
FIMOD / 98



UG 70
NERO MATT
FIMOD / 70



UG 72
TARTUFO
FIMOD / 72

744



COLORI DISPONIBILI

€ IVA esclusa



UM 41
ALLUMINIO
FIMOD / 41



UM 42
TITANIO
FIMOD / 42

744



DOTAZIONE

- 1 griglia
- 1 vassoio standard

CARATTERISTICHE

- Forno ventilato
- Classe di efficienza energetica A
- 7 funzioni
- Cavità extralarge 64 lt netti
- Ventilazione tangenziale di raffreddamento
- 5 livelli di cottura
- Porta fredda in triplo vetro temperato
- Vetro interno removibile
- Programmatore meccanico con fine cottura
- Interno con smalto titanium easy-to-clean, più facile da pulire
- Luce interna
- Maniglia nera e manopole milleluci nere



grill



cottura tradizionale ventilata



resistenza superiore + inferiore



resistenza superiore



resistenza inferiore



scongelamento



luce interna



64 L capacità



raffreddamento tangenziale

FITER / FORNO

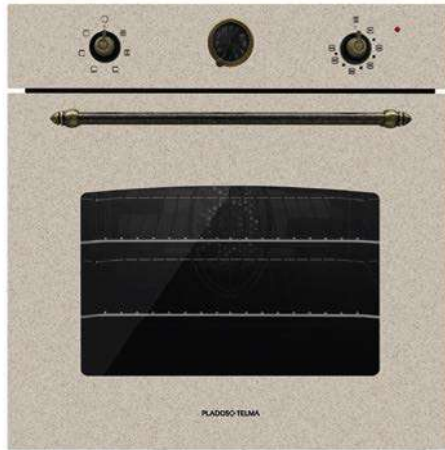

UG Avena 94

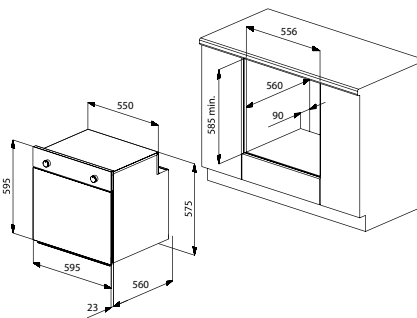

COLORI DISPONIBILI



UG 94
AVENA
FITER / 94

€ IVA
esclusa

804



DOTAZIONE

- 1 griglia
- 1 vassoio standard

CARATTERISTICHE

- Forno ventilato
- Classe di efficienza energetica A
- 6 funzioni
- Cavità extralarge 64 lt netti
- Ventilazione tangenziale di raffreddamento
- 5 livelli di cottura
- Porta fredda in triplo vetro temperato
- Vetro interno removibile
- Programmatore meccanico con fine cottura
- Interno con smalto titanium easy-to-clean, più facile da pulire
- Luce interna
- Maniglia e manopole finitura bronzo anticato



grill



cottura tradizionale
ventilata



resistenza superiore
+ inferiore



resistenza superiore



resistenza inferiore



scongelamento



luce interna



capacità



raffreddamento
tangenziale

LEGENDA SIMBOLI E RELATIVE FUNZIONI

SIMBOLOGIA FORNI:



COTTURA VENTILATA

La combinazione tra la ventola e la resistenza circolare permette la cottura di cibi diversi su più piani senza mescolanza di odori o sapori. Questa funzione è particolarmente indicata per cibi che devono essere ben cotti all'esterno e morbidi o rosei all'interno.



GRILL VENTILATO

Il funzionamento della ventola in combinazione con il grill esalta e velocizza le operazioni di gratinatura e grigliatura, con una maggiore distribuzione del calore, impedendo la bruciatura superficiale degli alimenti.



GRILL

Ideale per gratinare e grigliare le pietanze che necessitano di un'elevata temperatura superficiale come bistecche di vitello o manzo, filetto, hamburger e tutti i contorni di verdure alla griglia.



COTTURA TRADIZIONALE VENTILATA

Il funzionamento della ventola abbinato alla cottura tradizionale, diffonde il calore in modo uniforme all'interno del forno e risulta particolarmente indicata per cibi che richiedono lo stesso grado di cottura interno ed esterno quali arrostiti arrotondati, cosciotti, pesci interi, anche cotti simultaneamente su più livelli.



COTTURA INFERIORE VENTILATA

Il funzionamento della ventola abbinato alla cottura inferiore è ideale per dolci, torte e biscotti.



RESISTENZA SUPERIORE + INFERIORE (COTTURA TRADIZIONALE)

Il calore proveniente contemporaneamente dall'alto e dal basso, rende questa funzione ideale per pizze, torte, arrostiti di qualsiasi tipo e per carni grasse come anatra od oca.



RESISTENZA SUPERIORE (DORATURA)

Il calore proveniente solo dall'alto consente di completare le cotture di quei piatti che richiedono una leggera doratura superficiale. Ideale per rifinire la cottura di arrostiti e verdure.



RESISTENZA INFERIORE (COTTURA FINALE)

Il calore proveniente solo dal basso consente di rifinire le cotture che necessitano di una maggiore temperatura alla base. Indicata per completare la cottura di torte dolci o salate, pizze e crostate.



SCONGELAMENTO

Scongela delicatamente grazie all'azione della ventola interna.



LUCE FORNO

Permette di illuminare l'interno del forno per poter controllare la cottura dei cibi.



CAPACITÀ

È il volume interno del forno, cioè lo spazio utilizzabile per la cottura.



RAFFREDDAMENTO TANGENZIALE

Una ventola posta all'esterno del vano forno crea una corrente d'aria che evita il surriscaldamento dei mobili adiacenti, la formazione di condensa e di umidità.

CLASSI ENERGETICHE

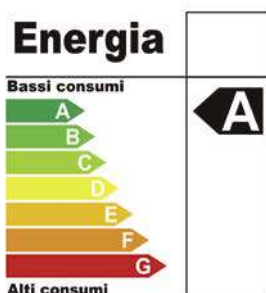

Le Direttive Europee stabiliscono la necessità di applicare un'etichetta energetica su tutti gli elettrodomestici. L'etichetta energetica classifica gli apparecchi in base al consumo di energia e di altre risorse, consentendo al consumatore di effettuare una **sceita consapevole** nel rispetto dell'ambiente e dell'economia. La lettera A indica consumi minori, le lettere dalla B in poi indicano consumi via via crescenti. Scegliere un elettrodomestico ad elevata efficienza energetica **ripaga in termini di costi sulla bolletta**. Gli elettrodomestici di CLASSE A sono progettati per funzionare con alti rendimenti, ottimizzando il consumo di energia e quindi riducendo l'inquinamento atmosferico.

Ridurre le spese in bolletta e contribuire ad un ambiente più pulito significa pensare al futuro del nostro pianeta ed è un dovere di tutti.



PIANI COTTURA A INDUZIONE

La superficie liscia dei piani a induzione rende la pulizia facile e veloce! A differenza dei piani cottura a gas con griglie e bruciatori che devono essere rimossi e riposizionati di volta in volta, il piano ad induzione torna a brillare con un semplice colpo di spugna.

PLADOS TELMA
INDUCTION



PIANI COTTURA A INDUZIONE CARATTERISTICHE DI PRODOTTO



PASSARE ALL'INDUZIONE È PIÙ SEMPLICE DI QUANTO PENSI.

Che si tratti della sostituzione di un vecchio piano cottura o di una prima installazione, il foro per l'incasso dei piani induzione Plados è compatibile con l'apertura standard dei piani cottura a gas. La profondità è sempre 48 cm.



ITALIAN
TECHNOLOGY

POWER MANAGEMENT SYSTEM:

Consente di regolare la potenza massima assorbita: il piano gestisce automaticamente la potenza in modo da non superare il limite impostato. La soglia può essere regolata scegliendo tra 4 diversi livelli (1 kW - 2,8 kW - 3,6 kW - 5,2 kW) a seconda del modello;

BOOSTER:

Nei piani dotati di funzione Booster, l'utente può incrementare la potenza di una zona cottura per velocizzare ulteriormente i processi di cottura;

OVERFLOW SAFETY:

In caso di fuoriuscita di un liquido da una pentola il piano si disattiva automaticamente;

BLOCCO DI SICUREZZA DEI COMANDI:

Una funzione di sicurezza per bloccare il piano, evitando accensioni accidentali o il cambio dei parametri precedentemente impostati.

POT DIAMETER DETECTION:

Il piano riconosce le dimensioni della pentola che viene appoggiata, attivando solo la porzione necessaria allo specifico diametro.

EFFICIENZA E RISPARMIO ENERGETICO

Il 90% dell'energia assorbita viene trasformata in calore. Appena la pentola viene rimossa dalla zona cottura, il trasferimento di energia viene interrotto evitando sprechi.

CONSUMI IN WATT: - 42%

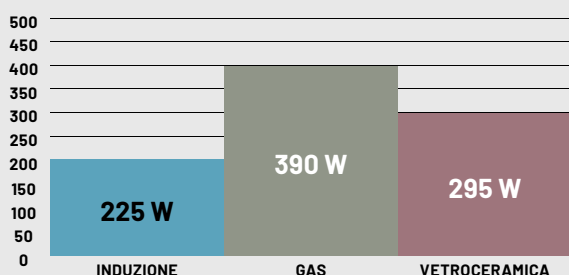

VELOCITÀ + 68%

Nei piani provvisti della funzione **Booster** l'utente può incrementare la potenza per abbattere drasticamente i processi di cottura.

MINUTI PER PORTARE 2 LITRI D'ACQUA DA 15 A 90 °C

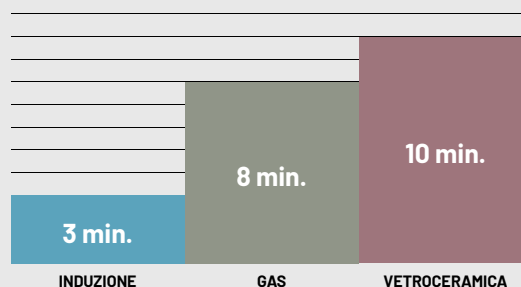

PBIL320C / INDUZIONE

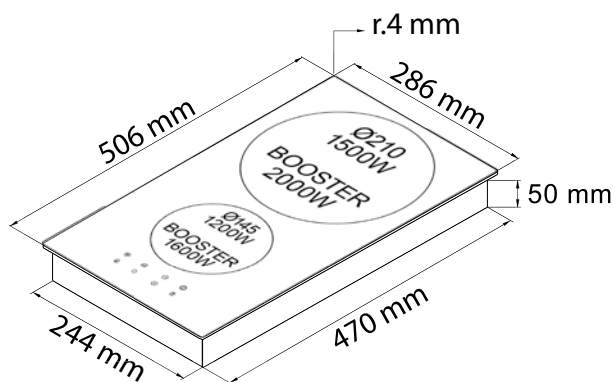
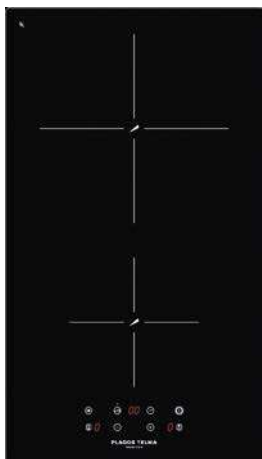

Foro per l'incasso:
270 x 480 mm

€ IVA
esclusa



CRISTALLO NERO
PBIL320C / K2

488



PBIM430 / INDUZIONE

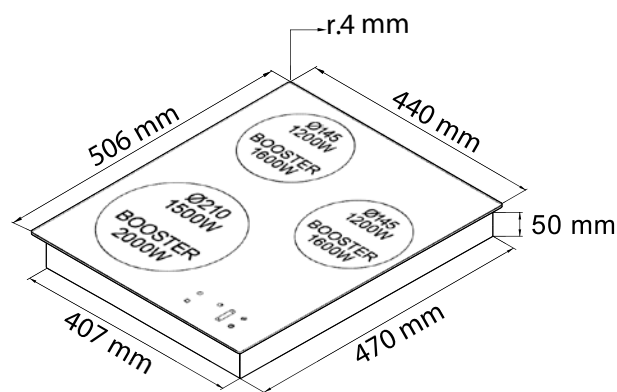
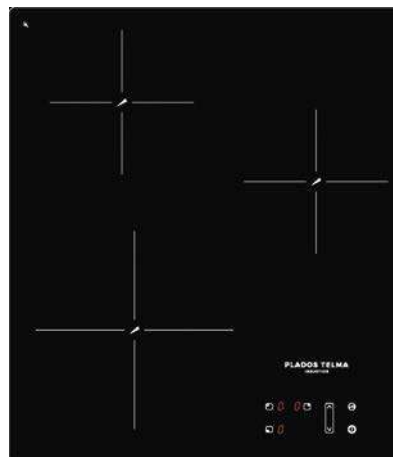

Foro per l'incasso:
420 x 480 mm

€ IVA
esclusa



CRISTALLO NERO
PBIM430 / K2

680



CARATTERISTICHE

Assorbimento massimo:	3,6 kW
Dimensioni:	29x51x5 cm
Versione standard:	Senza cornice
Comandi:	Controlli touch - 9 livelli di potenza
Zone cottura	2
Indicatore di potenza:	Si
Indicatore di calore residuo per zona:	Si
Blocco sicurezza comandi:	Si
Timer	Si
PMS	Si (Limitatore di consumo)
Booster	Si (Potenza supplementare)
Pot Diameter Detection	Si (Sensore diametro pentola)
Overflow Safety	Si (Sensore fuoriuscita liquidi)

CARATTERISTICHE

Assorbimento massimo:	5,2 kW
Dimensioni:	44x51x5 cm
Versione standard:	Senza cornice
Comandi:	Controlli touch - 9 livelli di potenza
Zone cottura	3
Indicatore di potenza:	Si
Indicatore di calore residuo per zona:	Si
Blocco sicurezza comandi:	Si
Timer	Si
PMS	Si (Limitatore di consumo)
Booster	Si (Potenza supplementare)
Pot Diameter Detection	Si (Sensore diametro pentola)
Overflow Safety	Si (Sensore fuoriuscita liquidi)

PBIM640C / INDUZIONE

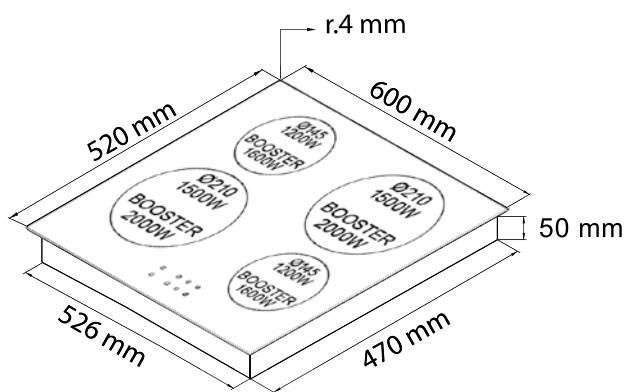
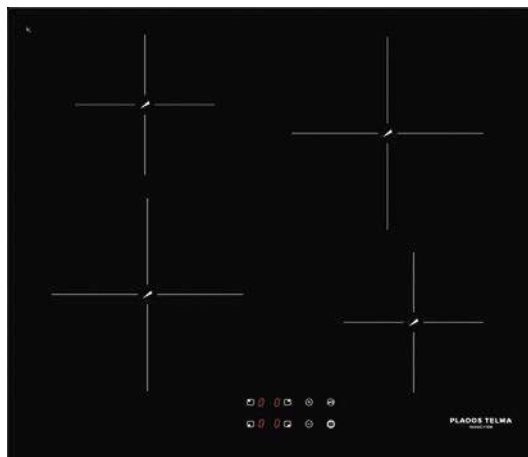

Foro per l'incasso:
560 x 480 mm

€ IVA
esclusa



CRISTALLO NERO
PBIM640C / K2

704



CARATTERISTICHE

Assorbimento massimo:	7,2 kW
Dimensioni:	60x52x5 cm
Versione standard:	Senza cornice
Comandi:	Controlli touch - 9 livelli di potenza
Zone cottura	4
Indicatore di potenza:	Si
Indicatore di calore residuo per zona:	Si
Blocco sicurezza comandi:	Si
Timer	Si
Booster	Si (Potenza supplementare)
Pot Diameter Detection	Si (Sensore diametro pentola)
Overflow Safety	Si (Sensore fuoriuscita liquidi)



PIANI COTTURA A GAS





PIANI COTTURA A GAS CARATTERISTICHE DI PRODOTTO



COLORI TRENDY

I piani cottura Plados sono disponibili nelle finiture più in voga nelle cucine contemporanee.



AMPIA GAMMA

10 modelli per coprire ogni necessità dal classico al moderno.



TRIPLA CORONA

3 potenti cerchi di fuoco per una cottura rapida e omogenea.

FINITURE



PLUS



ITALIAN
TECHNOLOGY

CORREDO

- Griglie in ghisa
- Griglie smaltate (serie STAR)

ACCESSORI

- Griglie in ghisa (serie STAR)
- manopole anticate
- manopole moderne

GLASS75 / PIANO COTTURA



Cristallo Nero

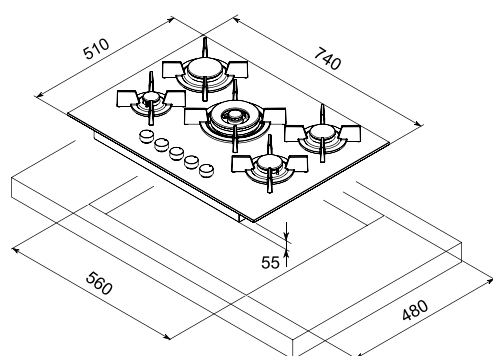

€ IVA esclusa



CRISTALLO NERO
GLASS75 / K2

660



GLASS60 / PIANO COTTURA



Cristallo Nero

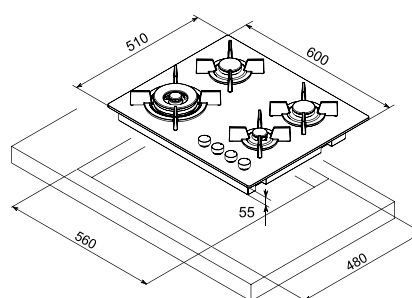

€ IVA esclusa



CRISTALLO NERO
GLASS60 / K2

536



DOTAZIONE

- Griglie in ghisa

CARATTERISTICHE

- Piano cottura in cristallo nero da 75 cm
- 5 fuochi gas di cui 1 tripla corona
- Comandi frontali
- Accensione elettronica sottomanopola
- Valvola di sicurezza
- Coprispartifiamma e griglie in ghisa
- Manopole color nero ghisa.
- Entrata GAS posteriore sinistra
- Foro per l'incasso: 560 x 480 mm

DOTAZIONE

- Griglie in ghisa

CARATTERISTICHE

- Piano cottura in cristallo nero da 60 cm
- 4 fuochi gas di cui 1 tripla corona
- Comandi frontali
- Accensione elettronica sottomanopola
- Valvola di sicurezza
- Coprispartifiamma e griglie in ghisa
- Manopole color nero ghisa.
- Entrata GAS posteriore sinistra
- Foro per l'incasso: 560 x 480 mm

ACCESSORI DISPONIBILI



Kit 5 manopole finitura
cromo satinato
MAMOD75

32



Kit 4 manopole finitura
cromo satinato
MAMOD60

26

SLIM75 / PIANO COTTURA



UG Tartufo 72



UG Nero Matt 70

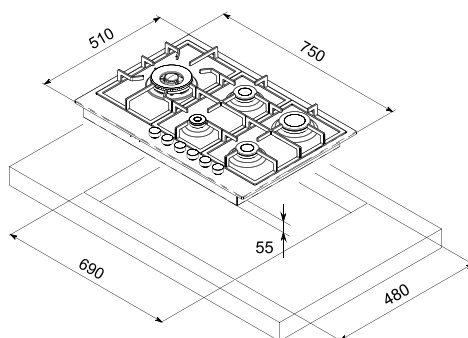

COLORI DISPONIBILI

€ IVA
esclusa



UG 70
NERO MATT
SLIM75 / 70

656



UG 72
TARTUFO
SLIM75 / 72

DOTAZIONE

- Griglie in ghisa

CARATTERISTICHE

- Piano cottura da 75 cm
- 5 fuochi gas di cui 1 tripla corona
- Comandi frontali
- Accensione elettronica sottomanopola
- Valvola di sicurezza
- Coprispartifiamma e griglie in ghisa
- Manopole color nero ghisa.
- Entrata GAS posteriore sinistra
- Foro per l'incasso: 690 x 480 mm

ACCESSORI DISPONIBILI



Kit 5 manopole finitura
cromo satinato
MAMOD75

32

FLAT75 / PIANO COTTURA



UM Alluminio 41



UG Bianco 98



UG Nero Matt 70



UG Tartufo 72



UM Alluminio 41



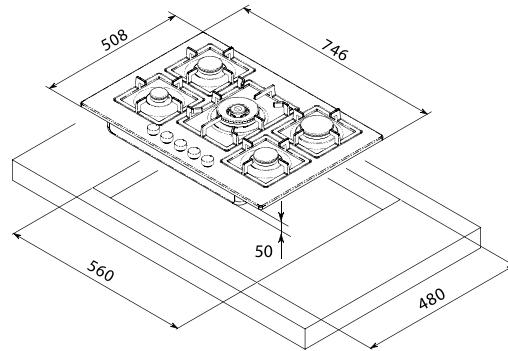

UM Titanio 42



COLORI DISPONIBILI

€ IVA esclusa

-  UG 98
BIANCO
FLAT75 / 98
-  UG 70
NERO MATT
FLAT75 / 70
-  UG 72
TARTUFO
FLAT75 / 72

590



COLORI DISPONIBILI

€ IVA esclusa

-  UM 41
ALLUMINIO
FLAT75 / 41
-  UM 42
TITANIO
FLAT75 / 42

608



DOTAZIONE

- Griglie in ghisa

CARATTERISTICHE

- Piano cottura da 75 cm
- 5 fuochi gas di cui 1 tripla corona
- Comandi frontali
- Accensione elettronica sottomanopola
- Valvola di sicurezza
- Coprispartifiamma e griglie in ghisa
- Manopole color nero ghisa.
- Entrata GAS posteriore sinistra
- Foro per l'incasso: 560 x 480 mm

ACCESSORI DISPONIBILI



Kit 5 manopole finitura cromo satinato
MAMOD75

32

FLAT60 / PIANO COTTURA



UM Titanio 42



UG Bianco 98



UG Nero Matt 70



UG Tartufo 72



UM Alluminio 41



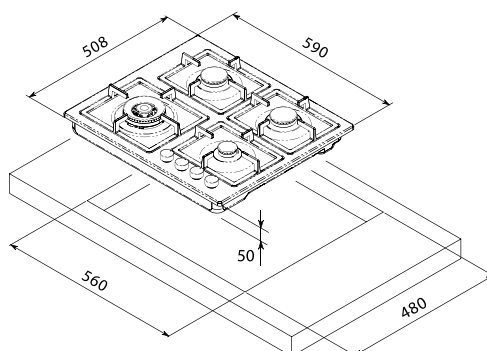

UM Titanio 42



COLORI DISPONIBILI

€ IVA esclusa

-  UG 98
BIANCO
FLAT60 / 98
-  UG 70
NERO MATT
FLAT60 / 70
-  UG 72
TARTUFO
FLAT60 / 72

494



COLORI DISPONIBILI

€ IVA esclusa

-  UM 41
ALLUMINIO
FLAT60 / 41
-  UM 42
TITANIO
FLAT60 / 42

512



DOTAZIONE

- Griglie in ghisa

CARATTERISTICHE

- Piano cottura da 60 cm
- 4 fuochi gas di cui 1 tripla corona
- Comandi frontali
- Accensione elettronica sottomanopola
- Valvola di sicurezza
- Coprispartifiamma e griglie in ghisa
- Manopole color nero ghisa.
- Entrata GAS posteriore sinistra
- Foro per l'incasso: 560 x 480 mm

ACCESSORI DISPONIBILI



Kit 4 manopole finitura cromo satinato
MAMOD60

26

STAR75 / PIANO COTTURA



CONFIGURAZIONE CLASSICA:

STAR75 Colore **UG Avena 94**
con griglie in ghisa **GRGH175**
e manopole anticate **MABR075**



UG 94 Avena



UG 70 Nero Matt

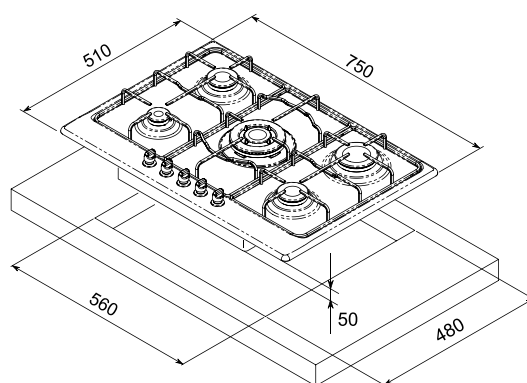

COLORI DISPONIBILI

€ IVA
esclusa

 UG 70
NERO MATT
STAR75 / 70

524



 UG 94
AVENA
STAR75 / 94

DOTAZIONE

- Griglie smaltate

CARATTERISTICHE

- Piano cottura da 75 cm
- 5 fuochi gas di cui 1 tripla corona
- Comandi frontali
- Accensione elettronica sottomanopola
- Valvola di sicurezza
- Coprispartifiamma e griglie in finitura smaltata
- Manopole nere
- Entrata GAS posteriore sinistra
- Foro per l'incasso: 560 x 480 mm

ACCESSORI DISPONIBILI

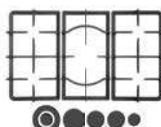

Copri-spartifiamma
e griglie in ghisa
GRGH175

152



Kit 5 manopole finitura
bronzo anticato
MABR075

58



Kit 5 manopole finitura
cromo satinato
MAM075

32

STAR60 / PIANO COTTURA



CONFIGURAZIONE CLASSICA:

STAR60 Colore **UG Avena 94**
con griglie in ghisa **GRGH162**
e manopole anticate **MABR060**



UG 94 Avena



UG 70 Nero Matt

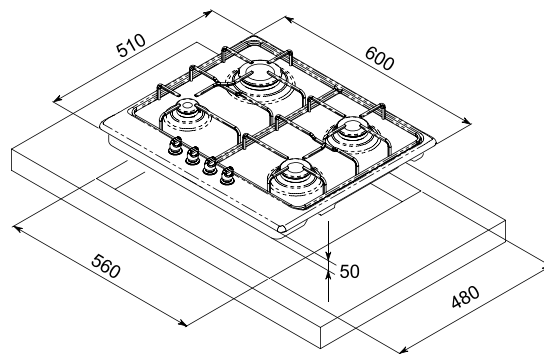

COLORI DISPONIBILI

€ IVA
esclusa



UG 70
NERO MATT
STAR60 / 70

408



UG 94
AVENA
STAR60 / 94

DOTAZIONE

- Griglie smaltate

CARATTERISTICHE

- Piano cottura da 60 cm
- 4 fuochi gas
- Comandi frontali
- Accensione elettronica sottomanopola
- Valvola di sicurezza
- Coprispartifiamma e griglie in finitura smaltata
- Manopole nere
- Entrata GAS posteriore sinistra
- Foro per l'incasso: 560 x 480 mm

ACCESSORI DISPONIBILI

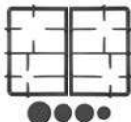

Copri-spartifiamma
e griglie in ghisa
GRGH162

114



Kit 4 manopole finitura
bronzo anticato
MABR060

48



Kit 4 manopole finitura
cromo satinato
MAMOD60

26

ACCESSORI OPTIONAL PER PIANI COTTURA A GAS



MAMOD75

Kit 5 manopole finitura cromo satinato.
Compatibili con: GLASS75, SLIM75, FLAT75, STAR75.



€ IVA
esclusa

32

MAMOD60

Kit 4 manopole finitura cromo satinato.
Compatibili con: GLASS60, SLIM60, FLAT60, STAR60.



€ IVA
esclusa

26

MABR075

Kit 5 manopole finitura bronzo antico per piano cottura STAR75.



€ IVA
esclusa

58

MABR060

Kit 4 manopole finitura bronzo antico per piano cottura STAR60.



€ IVA
esclusa

48

GRGHI75

Kit copri-spartifiamma e griglie in ghisa per piano cottura STAR75.

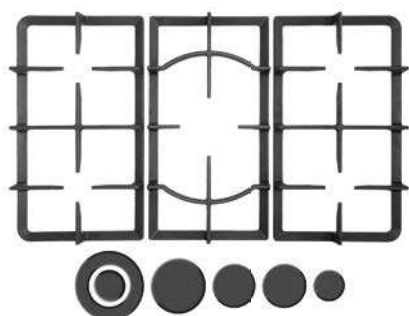

€ IVA
esclusa

152

GRGHI62

Kit copri-spartifiamma e griglie in ghisa per piano cottura STAR60.

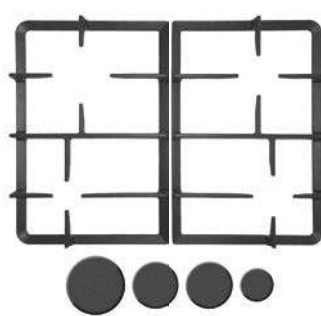

€ IVA
esclusa

114

GAMMA COLORI



È proprio nei colori che le proposte Plados trovano la massima espressione!

La nostra inimitabile gamma colori viene studiata e perfezionata di anno in anno al fine di garantire sempre un'offerta di colori aggiornata e di tendenza, migliorando di volta in volta le performances produttive e quindi i tempi di consegna dei lavelli.

GAMMA COLORI



rinnova

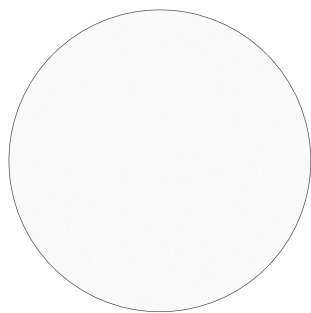

R1 - ARCTIC WHITE

Abbinabile con tutti i fabbricanti di elettrodomestici.



R2 - DUNE BEIGE

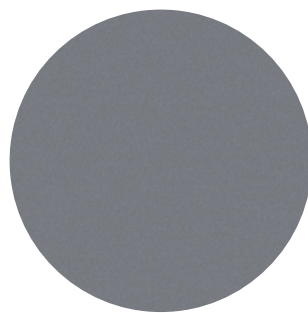

R3 - ALP STONE

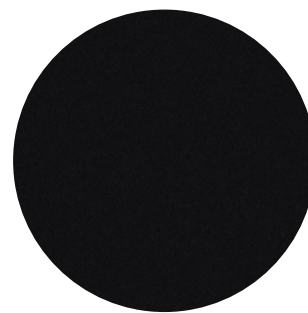

R4 - VOLCANO BLACK

Abbinabile con tutti i fabbricanti di elettrodomestici.



nanostone

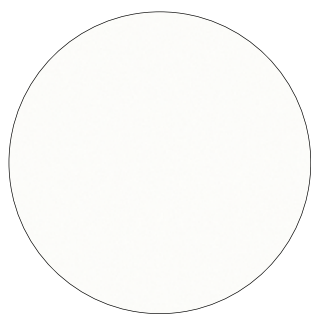

N1 - BIANCO LATTE

Abbinabile con tutti i fabbricanti di elettrodomestici.

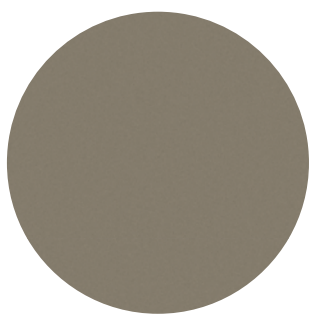

N3 - ARGAN

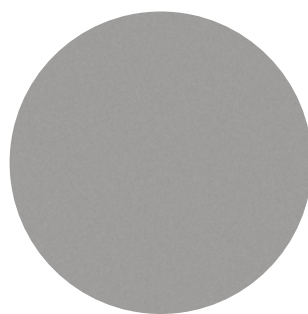

N4 - URBAN GREY

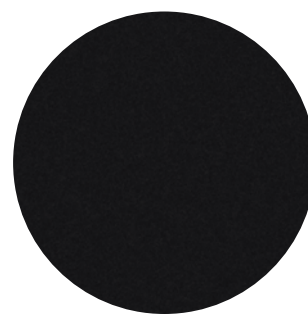

N6 - DEEP BLACK

Abbinabile con tutti i fabbricanti di elettrodomestici.



ultrametal



41 - ALLUMINIO

Abbinabile con: HOTPOINT-ARISTON (Argento SL), PLADOS, TELMA, SMEG, FRANKE, JOLLYNOX, SIEMENS, BOSCH.



42 - TITANIO

Abbinabile con: HOTPOINT-ARISTON, INDESIT, PLADOS, TELMA, JOLLYNOX, BOSCH, SIEMENS.



14 - CONCRETE



44 - NERO

Abbinabile con: HOTPOINT-ARISTON (Mirror MR), CANDY (Cristallo Nero), FRANKE, SIEMENS, BOSCH.

GAMMA COLORI



microultragranit



56 - JASMINE

Abbinabile con: HOTPOINT-ARISTON, REX/ELECTROLUX, CANDY, WHIRLPOOL, SMEG, NARDI, PLADOS, TELMA, FOSTER.

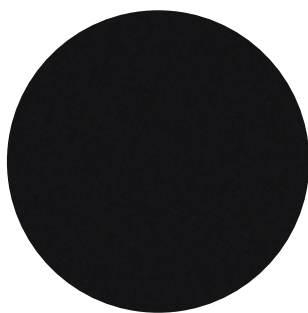

70 - NERO MATT

Abbinabile con tutti i fabbricanti di elettrodomestici.

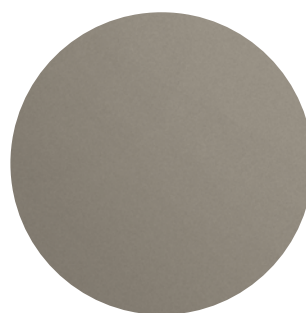

72 - TARTUFO

Abbinabile con: INDESIT, WHIRLPOOL, IGNIS, PLADOS, TELMA.



90 - BIANCO OPALE

Abbinabile con: HOTPOINT-ARISTON, REX/ELECTROLUX, CANDY, SMEG, NARDI, PLADOS, TELMA, FRANKE, JOLLYNOX.



94 - AVENA

Abbinabile con tutti i fabbricanti di elettrodomestici.



95 - NERO EBONY

Abbinabile con: REX/ELECTROLUX, CANDY, SMEG, NARDI, PLADOS, TELMA, FRANKE, JOLLYNOX.



98 - BIANCO

Abbinabile con tutti i fabbricanti di elettrodomestici.



ultraquartz



66 - TERRA DI FRANCIA

Abbinabile con tutti i fabbricanti di elettrodomestici.

altre finiture

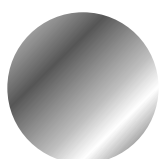

40 - CROMO

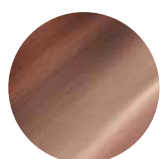

17 - RAME ANTICATO

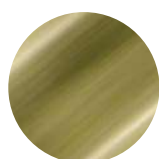

18 - BRONZO ANTICATO



PVD - RAME



PVD - ORO



PVD - GUN METAL

SERVIZI E ASSISTENZA

PLADOS È COSTANTEMENTE AL TUO FIANCO

GARANZIA PLADOS

La durata della garanzia Plados varia a seconda dei materiali e della categoria del prodotto. Di seguito sono elencate le categorie e la rispettiva durata della garanzia.



lavelli
RINNOVA e
nanoSTONE



lavelli
ULTRAMETAL e
microULTRAGRANIT



lavelli
INOX



miscelatori



elettrodomestici

PER POTER USUFRUIRE DELLA GARANZIA SI RACCOMANDA DI CONSERVARE IL DOCUMENTO DI ACQUISTO.

ASSISTENZA PRE-VENTITA

I social network rappresentano per Plados un importante canale di interazione con i propri clienti. L'azienda è infatti contattabile attraverso le pagine Facebook, Instagram e LinkedIn, oltre che telefonicamente e via e-mail:



pladostelma



@pladostelma



pladostelma



Plados & Telma



info@pladostelma.com

ASSISTENZA TECNICA **POST-VENDITA**

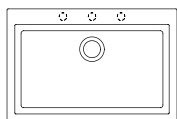

lavelli in composito

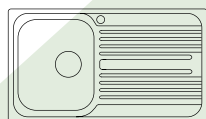

lavelli in acciaio inox

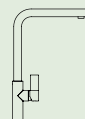

miscelatori



accessori

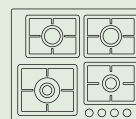

piani cottura a gas

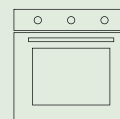

forni

PER RICHIEDERE ASSISTENZA SU LAVELLI IN MATERIALE COMPOSITO, IN ACCIAIO INOX, MISCELATORI, ACCESSORI, PIANI COTTURA A GAS, FORNI, PLADOS METTE A DISPOSIZIONE 3 MODALITÀ:



Chiama il nostro numero verde
**dal lunedì al venerdì,
dalle 9,30 alle 12,30
e dalle 14 alle 17.**



Compila il modulo che trovi alla
pagina **assistenza** del nostro
sito **www.pladostelma.com**
Rispondiamo entro 24 ore.



Scrivi un'e-mail a:
assistenza@pladostelma.com
Rispondiamo entro 24 ore.

IMPORTANTE! Per assistenza relativa ai LAVELLI, allegare all'e-mail la seguente documentazione:

- foto del prodotto con dettaglio del difetto/danneggiamento;
- foto dell'etichetta qualità posta sotto al lavello;
- codici del prodotto e del colore;
- documento fiscale.

PER RICHIEDERE ASSISTENZA SU CAPPE ASPIRANTI, PIANI COTTURA A INDUZIONE, DISSIPATORI,
O PER LA RICHIESTA DI RICAMBI DIGITARE I NUMERI:

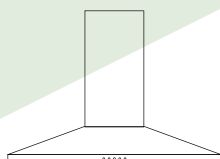

cappe aspiranti

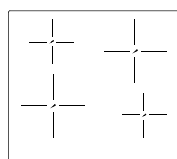

piani induzione



dissipatori



PER MAGGIORI INFORMAZIONI È POSSIBILE CONSULTARE LE F.A.Q. E LA SEZIONE ASSISTENZA
SUL NOSTRO SITO **WWW.PLADOSTELMA.COM**



CERTIFICAZIONI

PERCHÈ LA QUALITÀ DEI PRODOTTI
NASCE DALLA QUALITÀ DEI
PROCESSI PRODUTTIVI



ITALIAN
TECHNOLOGY



GARANZIA
FINO A 20
ANNI



30 ANNI
1991-2021



100% ECO
COMPATIBILE



Marchio CE

La certificazione di prodotto attesta che i prodotti sono conformi alle norme, direttive o disciplinari di settore e mette in evidenza la qualità, gli elementi di eccellenza e le peculiarità che li contraddistinguono. Tale processo di certificazione prevede lo svolgimento di prove iniziali di tipo sul prodotto, la valutazione iniziale, la successiva sorveglianza del processo produttivo ed infine, mediante test di laboratorio su campioni prelevati in fabbrica o sul mercato, la garanzia delle effettive prestazioni del prodotto rispetto alle norme di riferimento.

La Tracciabilità

Al fine di assicurare la massima garanzia al consumatore, Plados ha attivato una procedura interna che consente all'azienda di risalire in qualsiasi momento al lotto di produzione dell'articolo e dei componenti utilizzati.



Azienda con sistema di gestione qualità certificato ISO 9001

Le certificazioni definiscono i requisiti per l'implementazione di sistemi di gestione volti a condurre i vari processi aziendali in modo tale da migliorarne l'efficacia e l'efficienza, sia nelle fasi di realizzazione del prodotto che in quelle di erogazione del servizio, ottenendo ed incrementando la soddisfazione del cliente.



Imballaggi certificati



Lavelli destinati al mercato U.S.A. certificati



Elettrodomestici certificati

Art Direction, Fotografia, Fotoritocco, Impaginazione:
Reparto Grafica Plados S.p.A.

Immagini virtuali 3D: Zeen Visual

Altre immagini: freepik.com | vecteezy.com | pexels.com

Stampa: Tecnostampa S.r.l.

Condizioni generali di vendita

La merce viaggia a rischio e pericolo del committente, anche se venduta franco destino.
Trascorsi 5 giorni dal ricevimento della merce non si accettano reclami, né resi.

Imballo:

In scatole di cartone comprese nel prezzo.

È stato fatto ogni sforzo per riprodurre colori e materiali accuratamente, tuttavia a causa dei processi di fotografia e stampa, potrebbero verificarsi delle alterazioni di colore. Ogni dato contenuto all'interno del catalogo generale Plados è da ritenersi esatto, salvo errori ed omissioni, per i quali la Plados S.p.A. non è in alcun modo responsabile. La Plados S.p.A. si riserva il diritto di modificare, in qualsiasi momento e senza preavviso, le caratteristiche tecniche, i colori ed i materiali di ogni prodotto presente nel catalogo. La disponibilità di tutti i modelli è soggetta a verifica da parte dell'azienda costruttrice. Il colore di tutti i prodotti presenti deve ritenersi puramente indicativo.

Promozione Esclusiva SERIE ROXANA



Dalle forme morbide ed eleganti, la serie Roxana si adatta a qualsiasi tipologia di cucine componibili, dallo stile classico a quello contemporaneo.

Acquistando uno dei lavelli Roxana, potrai avere un miscelatore ad un prezzo promozionale.

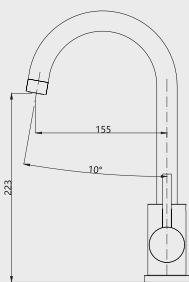
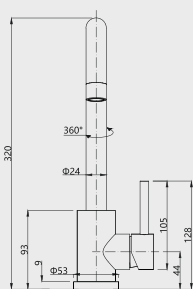

IN OMAGGIO:

EK4

Miscelatore monocomando con canna tubolare girevole. Altezza 32 cm.

- | | | | | |
|--------------------|----------------------------|-----------------------|------------------------|---------------------------|
| | | | | |
| 40
Cromo | IX
Inox satinato | UG 94
Avena | UG 98
Bianco | UG 70
Nero matt |

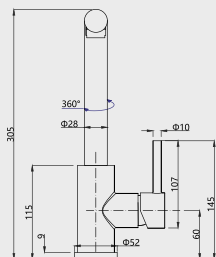
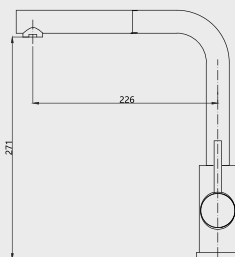

A soli + € 44 in più:

EK2

Miscelatore monocomando con canna a 90° e doccia estraibile. Altezza 30,5 cm.

- | | | | | |
|--------------------|----------------------------|-----------------------|------------------------|---------------------------|
| | | | | |
| 40
Cromo | IX
Inox satinato | UG 94
Avena | UG 98
Bianco | UG 70
Nero matt |



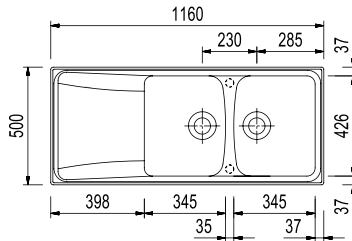

R01162 / ROXANA

Dimensioni: 1160 x 500 mm
 Profondità vasca: 200 mm
 Foro incasso: 1140 x 480 mm
 Base: 800 mm



MICROULTRAGRANIT

€ IVA esclusa

	UG 98 BIANCO R01162/98	
	UG 94 AVENA R01162/94	
	UG 70 NERO MATT R01162/70	
	UM 42 TITANIO R01162/42	

376



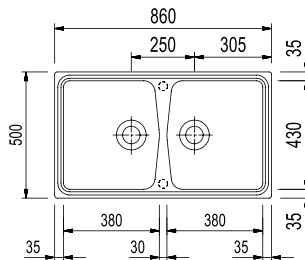

R00862 / ROXANA

Dimensioni: 860 x 500 mm
 Profondità vasca: 200 mm
 Foro incasso: 840 x 480 mm
 Base: 900 mm



MICROULTRAGRANIT

€ IVA esclusa

	UG 98 BIANCO R00862/98	
	UG 94 AVENA R00862/94	
	UG 70 NERO MATT R00862/70	
	UM 42 TITANIO R00862/42	

362



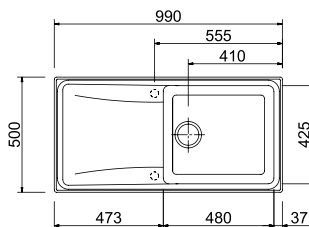

R09910 / ROXANA

Dimensioni: 990 x 500 mm
 Profondità vasca: 210 mm
 Foro incasso: 970 x 480 mm
 Base: 600 mm



MICROULTRAGRANIT

€ IVA esclusa

	UG 98 BIANCO R09910/98	
	UG 94 AVENA R09910/94	
	UG 70 NERO MATT R09910/70	
	UM 42 TITANIO R09910/42	

376

ACCESSORI CONSIGLIATI



1_TAGL88



2_TAGP66



2_SPCEINX



4_ROLLMAT

R00861 / ROXANA

Dimensioni: 860 x 500 mm
 Profondità vasca: 200 mm
 Foro incasso: 840 x 480 mm
 Base: 500 mm

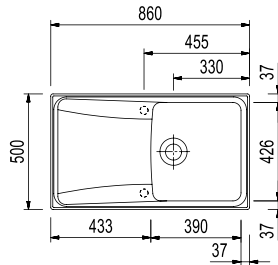

MICROULTRAGRANIT

€ IVA esclusa

-  UG 98 BIANCO R00861/98
-  UG 94 AVENA R00861/94
-  UG 70 NERO MATT R00861/70
-  UM 42 TITANIO R00861/42



348



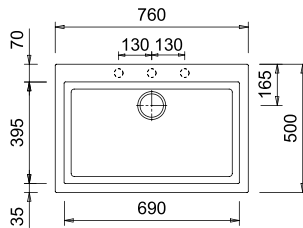

R07610/ ROXANA

Dimensioni: 760 x 500 mm
 Profondità vasca: 200 mm
 Foro incasso: 740 x 480 mm
 Base: 800 mm



MICROULTRAGRANIT

€ IVA esclusa

-  UG 98 BIANCO R07610/98
-  UG 94 AVENA R07610/94
-  UG 70 NERO MATT R07610/70
-  UM 42 TITANIO R07610/42



420



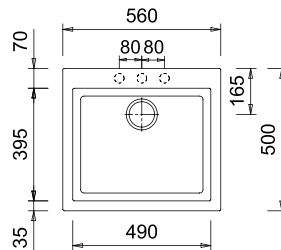

R05610 / ROXANA

Dimensioni: 560 x 500 mm
 Profondità vasca: 200 mm
 Foro incasso: 540 x 480 mm
 Base: 600 mm



MICROULTRAGRANIT

€ IVA esclusa

-  UG 98 BIANCO R05610/98
-  UG 94 AVENA R05610/94
-  UG 70 NERO MATT R05610/70
-  UM 42 TITANIO R05610/42



390

ACCESSORI CONSIGLIATI



1_TAGL88



2_TAGP66



2_SPCESINX

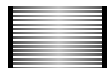

4_ROLLMAT

EK4

Miscelatore monocomando con canna tubolare girevole. Altezza 32 cm.



NEW

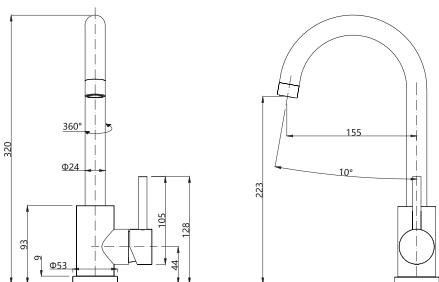

- Cartuccia a dischi ceramici Ø35 mm (alta)
- Rotazione canna: 360°
- Foro sul lavello: Ø35 mm
- Flessibili di allacciamento in acciaio inox, L=35 cm
- Diametro base: 50 mm







€ IVA esclusa

	40 CROMO EK4 / 40	100	
	ACCIAIO SATINATO EK4 / 40	100	

MICROULTRAGRANIT

€ IVA esclusa

	UG 94 AVENA EK4 / 94	100	
	UG 98 BIANCO EK4 / 98		
	UG 70 NERO MATT EK4 / 70		

EK2

Miscelatore monocomando con canna a 90° e doccia estraibile. Altezza 30,5 cm.

NEW



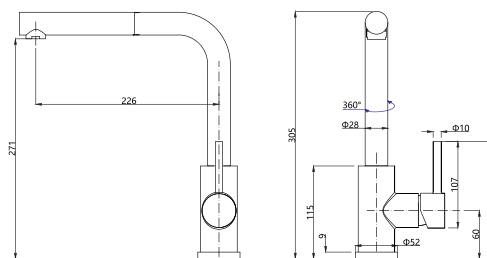

GETTO CENTRALE

- Cartuccia a dischi ceramici Ø35 mm (alta)
- Rotazione canna: 180°
- Foro sul lavello: Ø35 mm
- Flessibili di allacciamento in acciaio inox, L=35 cm
- Flessibile doccia in nylon, L=150 cm
- Diametro base: 50 mm







€ IVA esclusa

	40 CROMO EK2 / 40	146	
	ACCIAIO SATINATO EK2 / 40	146	

MICROULTRAGRANIT

€ IVA esclusa

	UG 94 AVENA EK2 / 94	146	
	UG 98 BIANCO EK2 / 98		
	UG 70 NERO MATT EK2 / 70		



CEDI S.p.A.
Via F.lli Bandiera, snc - 80026 Casoria (NA)
Tel. (+39) 081-5844781 - Fax (+39) 081-5846364
E-mail: info@cedispa.it - www.cedispa.it

Filiale di Pescara:
Via Lago di Chiusi, 4 - 65128 Pescara (PE)
Tel. (+39) 085-50899 - Fax (+39) 085-50599
E-mail: infopescara@cedispa.it

Filiale di Pesaro:
Strada della Fornace vecchia, 6 - 61122 Pesaro (PU)
Tel. (+39) 0721-205866 - Fax. (+39) 0721-203479
E-mail: infopesaro@cedispa.it

Filiale di Barberino Tavarnelle:
Uffici & Showroom:
Via Pisana, 35 - 50028 Barberino Tavarnelle (FI)
Tel (+39) 055-807991
E-mail: infobarberino@cedispa.it

DISTRIBUTORE AUTORIZZATO

PLADOS
KITCHEN EXPERIENCE

PLADOS S.p.A.
Via Grazia Deledda, 3 - 62010 Montecassiano (MC) ITALY
Tel. +39 0733 290592 - Fax +39 0733 298070
info@pladostelma.com - www.pladostelma.com